

VACON[®] 100 FLOW
AC DRIVES

APPLICATION MANUAL

VACON[®]

PREFACE

DOCUMENT DETAILS

Document ID:	DPD01083G
Date:	12.6.2017
Software version:	FW0159V017

ABOUT THIS MANUAL

This manual is copyright of Vacon Ltd. All Rights Reserved. The manual is subject to change without prior notice. The language of the original instructions is English.

In this manual, you can read about the functions of the VACON® AC drive and how to use the drive. The manual has the same structure than the menu of the drive (chapters 1 and 4-8).

Chapter 1, Quick Startup Guide

- How to start the work with the control panel.

Chapter 2, Wizards

- Making a selection of the application configuration.
- Setting up an application quickly.
- The different applications with examples.

Chapter 3, User Interfaces

- The display types and how to use the control panel.
- The PC tool VACON® Live.
- The functions of the fieldbus.

Chapter 4, Monitoring menu

- Data on the monitoring values.

Chapter 5, Parameter menu

- A list of all the parameters of the drive.

Chapter 6, Diagnostics menu

Chapter 7, I/O and Hardware menu

Chapter 8, User settings, favourites and user level menus

Chapter 9, Monitoring value descriptions

Chapter 10, Parameter descriptions

- How to use the parameters.
- Digital and analogue input programming.
- Application-specific functions.

Chapter 11, Fault tracing

- The faults and their causes.
- Resetting the faults.

Chapter 12, Appendix

- Data on the different default values of the applications.

This manual includes a large quantity of parameter tables. These instructions tell you how to read the tables.

A	B	C	D	E	F	G	H
Index	Parameter	Min	Max	Unit	Default	ID	Description

- | | |
|---|--|
| <p>A. The location of the parameter in the menu, that is, the parameter number.</p> <p>B. The name of the parameter.</p> <p>C. The minimum value of the parameter.</p> <p>D. The maximum value of the parameter.</p> <p>E. The unit of the value of the parameter. The unit shows if it is available.</p> | <p>F. The value that was set in the factory.</p> <p>G. The ID number of the parameter.</p> <p>H. A short description of the values of the parameter and/or its function.</p> |
|---|--|

NOTE! You can download the English and French product manuals with applicable safety, warning and caution information from <http://drives.danfoss.com/knowledge-center/technical-documentation/>.

REMARQUE Vous pouvez télécharger les versions anglaise et française des manuels produit contenant l'ensemble des informations de sécurité, avertissements et mises en garde applicables sur le site <http://drives.danfoss.com/knowledge-center/technical-documentation/>.

FUNCTIONS OF THE VACON® AC DRIVE

- You can select the necessary application for your process: Standard, HVAC, PID control, Multi-pump (single drive) or Multi-pump (multidrive). The drive automatically makes some of the necessary settings, which makes the commissioning easy.
- Wizards for the first startup and the Fire mode.
- Wizards for each application: Standard, HVAC, PID control, Multi-pump (single drive) and Multi-pump (multidrive).
- The FUNCT button for an easy change between the local and the remote control place. The remote control place can be I/O or fieldbus. You can make a selection of the remote control place with a parameter.
- 8 preset frequencies.
- Motor potentiometer functions.
- A flush function.
- 2 ramp times that you can program, 2 supervisions and 3 ranges of prohibited frequencies.
- A forced stop.
- A control page to operate and monitor of the most important values quickly.
- A fieldbus data mapping.
- An automatic reset.
- Different pre-heat modes to prevent condensation problems.
- A maximum output frequency of 320 Hz.
- A Real time clock and timer functions (an optional battery is necessary). It is possible to program 3 time channels to get different functions on the drive.
- An external PID controller is available. You can use it, for example, to control a valve with the I/O of the AC drive.
- A sleep mode function that automatically enables and disables the operation of the drive to save energy.
- A 2-zone PID controller with 2 different feedback signals: minimum and maximum control.
- 2 setpoint sources for the PID control. You can make the selection with a digital input.
- A function for PID setpoint boost.
- A feedforward function to make the response to the process changes better.
- A process value supervision.
- A multi-pump control for the single drive and multidrive systems.
- The multimaster and multifollower modes in the multidrive system.
- A multi-pump system that uses a real time clock to autochange the pumps.
- A maintenance counter.
- Pump control functions: priming pump control, jockey pump control, pump impeller auto-cleaning, pump input pressure supervision and frost protection function.

TABLE OF CONTENTS

Preface

Document details	3
About this manual	3
Functions of the VACON® AC drive	5
1 Quick Startup Guide	12
1.1 Control panel and keypad	12
1.2 The displays	12
1.3 First startup	13
1.4 Description of the applications	14
1.4.1 Standard and HVAC applications	14
1.4.2 PID control application	22
1.4.3 Multi-pump (single drive) application	30
1.4.4 Multi-pump (multidrive) application	43
2 Wizards	77
2.1 Standard application wizard	77
2.2 HVAC application wizard	78
2.3 PID control application wizard	79
2.4 Multi-pump (single drive) application wizard	81
2.5 Multi-pump (multidrive) application wizard	84
2.6 Fire mode wizard	88
3 User interfaces	90
3.1 Navigation on the keypad	90
3.2 Using the graphical display	92
3.2.1 Editing the values	92
3.2.2 Resetting a fault	95
3.2.3 The FUNCT button	95
3.2.4 Copying the parameters	99
3.2.5 Comparing the parameters	100
3.2.6 Help texts	102
3.2.7 Using the Favourites menu	103
3.3 Using the text display	103
3.3.1 Editing the values	104
3.3.2 Resetting a fault	105
3.3.3 The FUNCT button	105
3.4 Menu structure	109
3.4.1 Quick setup	110
3.4.2 Monitor	110
3.5 VACON® Live	112

4	Monitoring menu	113
4.1	Monitor group	113
4.1.1	Multimonitor	113
4.1.2	Trend curve	114
4.1.3	Basic	117
4.1.4	I/O	119
4.1.5	Temperature inputs	119
4.1.6	Extras and advanced	120
4.1.7	Timer functions monitoring	121
4.1.8	PID controller monitoring	122
4.1.9	External PID controller monitoring	123
4.1.10	Multi-pump monitoring	123
4.1.11	Maintenance counters	125
4.1.12	Fieldbus process data monitoring	125
4.1.13	Drive customizer monitoring	126
5	Parameters menu	127
5.1	Group 3.1: Motor settings	127
5.2	Group 3.2: Start/stop setup	131
5.3	Group 3.3: References	133
5.4	Group 3.4: Ramps and brakes setup	136
5.5	Group 3.5: I/O configuration	138
5.6	Group 3.6: Fieldbus data mapping	149
5.7	Group 3.7: Prohibit frequencies	150
5.8	Group 3.8: Supervisions	151
5.9	Group 3.9: Protections	152
5.10	Group 3.10: Automatic reset	158
5.11	Group 3.11: Application settings	159
5.12	Group 3.12: Timer functions	159
5.13	Group 3.13: PID controller	162
5.14	Group 3.14: External PID controller	174
5.15	Group 3.15: Multi-pump	177
5.16	Group 3.16: Maintenance counters	180
5.17	Group 3.17: Fire mode	181
5.18	Group 3.18: Motor preheat parameters	182
5.19	Group 3.19: Drive customizer	182
5.20	Group 3.21: Pump control	183
5.21	Group 3.23: Advanced harmonic filter	186
6	Diagnostics menu	187
6.1	Active faults	187
6.2	Reset faults	187
6.3	Fault history	187
6.4	Total counters	187
6.5	Trip counters	189
6.6	Software info	190

7	I/O and hardware menu	191
7.1	Basic I/O	191
7.2	Option board slots	193
7.3	Real time clock	194
7.4	Power unit settings	194
7.5	Keypad	195
7.6	Fieldbus	196
8	User settings, favourites and user level menus	197
8.1	User settings	197
8.1.1	User settings	197
8.1.2	Parameter backup	198
8.2	Favourites	198
8.2.1	Adding an item to the Favourites	199
8.2.2	Removing an item from the Favourites	199
8.3	User levels	200
8.3.1	Changing the access code of the user levels	201
9	Monitoring value descriptions	203
9.1	Basic	203
9.2	I/O	204
9.3	Temperature inputs	205
9.4	Extras and advanced	206
9.5	Timer functions	208
9.6	PID controller	209
9.7	External PID controller	209
9.8	Multi-pump	210
9.9	Maintenance counters	211
9.10	Fieldbus data	211
9.11	Drive customizer	215
10	Parameter descriptions	217
10.1	Trend curve	217
10.2	Motor settings	218
10.2.1	Motor nameplate parameters	218
10.2.2	Motor control parameters	219
10.2.3	Motor limits	224
10.2.4	Open loop parameters	224
10.2.5	I/f start function	228
10.2.6	Torque stabilator function	229
10.3	Start/Stop setup	230
10.4	References	240
10.4.1	Frequency reference	240
10.4.2	Preset frequencies	241
10.4.3	Motor potentiometer parameters	245
10.4.4	Flushing parameters	246

10.5	Ramps and brakes setup	247
10.5.1	Ramp 1	247
10.5.2	Ramp 2	248
10.5.3	Start magnetising	249
10.5.4	DC brake	250
10.5.5	Flux braking	250
10.6	I/O configuration	250
10.6.1	Programming of digital and analogue inputs	250
10.6.2	Default functions of programmable inputs	261
10.6.3	Digital inputs	261
10.6.4	Analogue inputs	267
10.6.5	Digital outputs	272
10.6.6	Analogue outputs	276
10.7	Fieldbus data map	280
10.8	Prohibit frequencies	281
10.9	Supervisions	283
10.10	Protections	283
10.10.1	General	283
10.10.2	Motor thermal protections	285
10.10.3	Motor stall protection	289
10.10.4	Underload (Dry pump) protection	291
10.10.5	Quick stop	293
10.10.6	AI low protection	294
10.11	Automatic reset	296
10.12	Application settings	298
10.13	Timer functions	298
10.14	PID controller	303
10.14.1	Basic settings	303
10.14.2	Setpoints	305
10.14.3	Feedback	306
10.14.4	Feedforward	306
10.14.5	Sleep function	308
10.14.6	Feedback supervision	310
10.14.7	Pressure loss compensation	312
10.14.8	Soft fill	313
10.14.9	Input pressure supervision	315
10.14.10	Sleep function when no demand is detected	317
10.14.11	Multi-setpoint	319
10.15	External PID controller	321
10.16	Multi-pump function	321
10.16.1	Multi-pump (multidrive) commissioning checklist	321
10.16.2	System configuration	323
10.16.3	Interlocks	328
10.16.4	Feedback sensor connection in a multi-pump system	329
10.16.5	Overpressure supervision	338
10.16.6	Pump runtime counters	339
10.16.7	Advanced settings	341

10.17	Maintenance counters	342
10.18	Fire mode	343
10.19	Motor preheat function	346
10.20	Drive customizer	347
10.21	Pump control	348
10.21.1	Auto-cleaning	348
10.21.2	Jockey pump	350
10.21.3	Priming pump	352
10.21.4	Anti-blocking function	353
10.21.5	Frost protection	353
10.21.6	Flow switch	354
10.22	Counters	355
10.22.1	Operating time counter	355
10.22.2	Operating time trip counter	355
10.22.3	Run time counter	356
10.22.4	Power on time counter	356
10.22.5	Energy counter	357
10.22.6	Energy trip counter	358
10.23	Advanced harmonic filter	359
11	Fault tracing	360
11.1	A fault comes into view	360
11.1.1	Resetting with the Reset button	360
11.1.2	Resetting with a parameter in the graphical display	360
11.1.3	Resetting with a parameter in the text display	361
11.2	Fault history	362
11.2.1	Examining the Fault history in the graphical display	362
11.2.2	Examining the Fault history in the text display	363
11.3	Fault codes	365
12	Appendix 1	380
12.1	The default values of parameters in the different applications	380

1 QUICK STARTUP GUIDE

1.1 CONTROL PANEL AND KEYPAD

The control panel is the interface between the AC drive and the user. With the control panel, you can control the speed of a motor and monitor the status of the AC drive. You can also set the parameters of the AC drive.

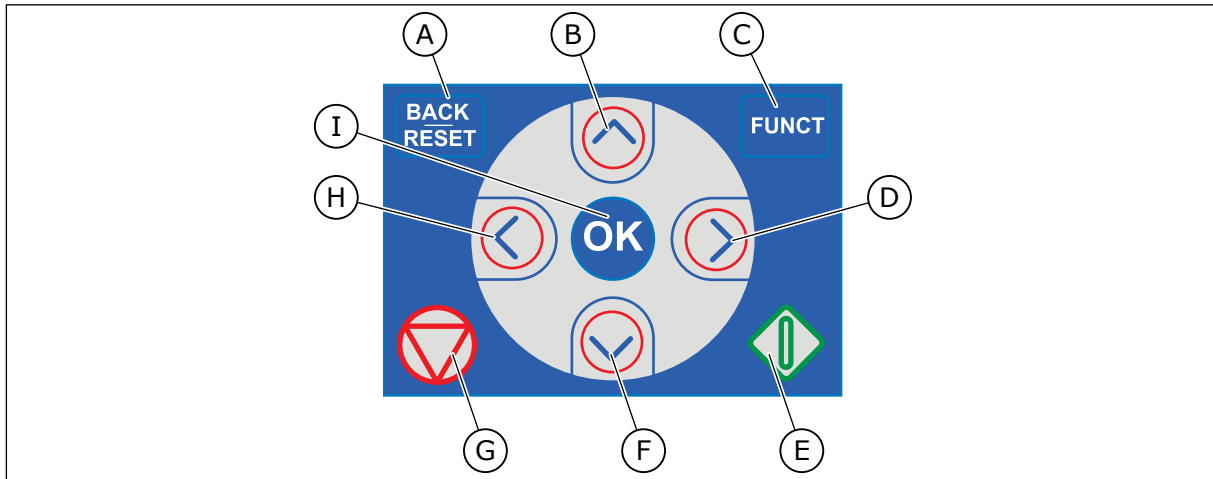

Fig. 1: The buttons of the keypad

- | | |
|---|--|
| <p>A. The BACK/RESET button. Use it to move back in the menu, exit the Edit mode, reset a fault.</p> <p>B. The arrow button UP. Use it to scroll the menu up and to increase a value.</p> <p>C. The FUNCT button. Use it to change the rotation direction of the motor, access the control page, and change the control place. See more in 3.3.3 <i>The FUNCT button</i>.</p> | <p>D. The arrow button RIGHT.</p> <p>E. The START button.</p> <p>F. The arrow button DOWN. Use it to scroll the menu down and to decrease a value.</p> <p>G. The STOP button.</p> <p>H. The arrow button LEFT. Use it to move the cursor left.</p> <p>I. The OK button. Use it to go into an active level or item, or to accept a selection.</p> |
|---|--|

1.2 THE DISPLAYS

There are 2 display types: the graphical display and the text display. The control panel always has the same keypad and buttons.

The display shows this data.

- The status of the motor and the drive.
- Faults in the motor and in the drive.
- Your location in the menu structure.

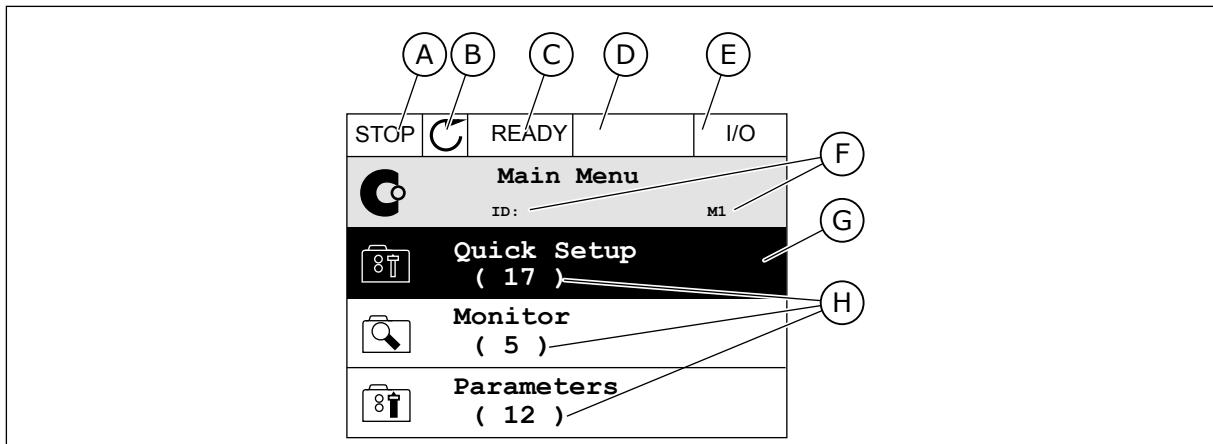

Fig. 2: The graphical display

- A. The first status field: STOP/RUN
- B. The rotation direction of the motor
- C. The second status field: READY/NOT READY/FAULT
- D. The alarm field: ALARM/-
- E. The control place field: PC/I/O/KEYPAD/ FIELDBUS
- F. The location field: the ID number of the parameter and the current location in the menu
- G. An activated group or item
- H. The number of items in the group in question

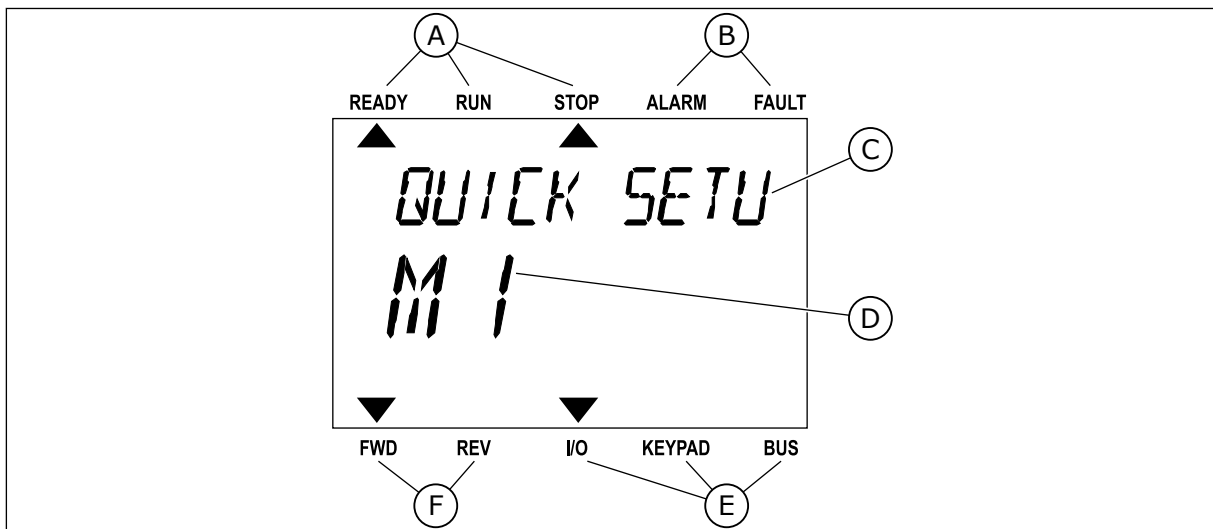

Fig. 3: The text display. If the text is too long to show, the text scrolls automatically on the display.

- A. The indicators of status
- B. The indicators of alarm and fault
- C. The name of the group or item of the current location
- D. The current location in the menu
- E. The indicators of the control place
- F. The indicators of the rotation direction

1.3 FIRST STARTUP

After you do power-up of the drive, the Startup wizard starts. The Startup wizard tells you to give necessary data for the drive to control your procedure.

1	Language selection (P6.1)	The selection is different in all the language packages
2	Daylight saving* (P5.5.5)	Russia US EU OFF
3	Time* (P5.5.2)	hh:mm:ss
4	Year* (P5.5.4)	yyyy
5	Date* (P5.5.3)	dd.mm.

* If a battery is installed, you see these steps

6	Run Startup Wizard?	Yes No
---	---------------------	-----------

Select *Yes* and push the OK button. If you select *No*, the AC drive moves away from the Startup wizard.

To set the parameter values manually, select *No* and push the OK button.

7	Select the application (P1.2 Application, ID212)	Standard HVAC PID control Multi-pump (single drive) Multi-pump (multidrive)
---	--	---

To continue to the wizard of the application you selected in step 7, select *Yes* and push the OK button. See the description of the application wizards in *2 Wizards*.

If you select *No* and push the OK button, the Startup wizard stops and you must select all the parameter values manually.

To start the Startup wizard again, you have 2 alternatives. Go to the parameter P6.5.1 Restore Factory Defaults or to the parameter B1.1.2 Startup Wizard. Then set the value to *Activate*.

1.4 DESCRIPTION OF THE APPLICATIONS

Use the parameter P1.2 (Application) to make a selection of an application for the drive. Immediately when the parameter P1.2 changes, a group of parameters get their preset values.

1.4.1 STANDARD AND HVAC APPLICATIONS

Use the Standard and HVAC applications to control pumps or fans, for example.

It is possible to control the drive from the Keypad, Fieldbus or I/O terminal.

When you control the drive with the I/O terminal, the frequency reference signal is connected to AI1 (0...10V) or AI2 (4...20mA). The connection is specified by the type of the signal. There are also 3 preset frequency references available. You can activate the preset frequency references with DI4 and DI5. The start and stop signals of the drive are connected to DI1 (start forward) and DI2 (start reverse).

It is possible to configure all the drive outputs freely in all the applications. There are 1 analogue output (Output Frequency) and 3 relay outputs (Run, Fault, Ready) available on the basic I/O board.

See the descriptions of the parameters in *10 Parameter descriptions*.

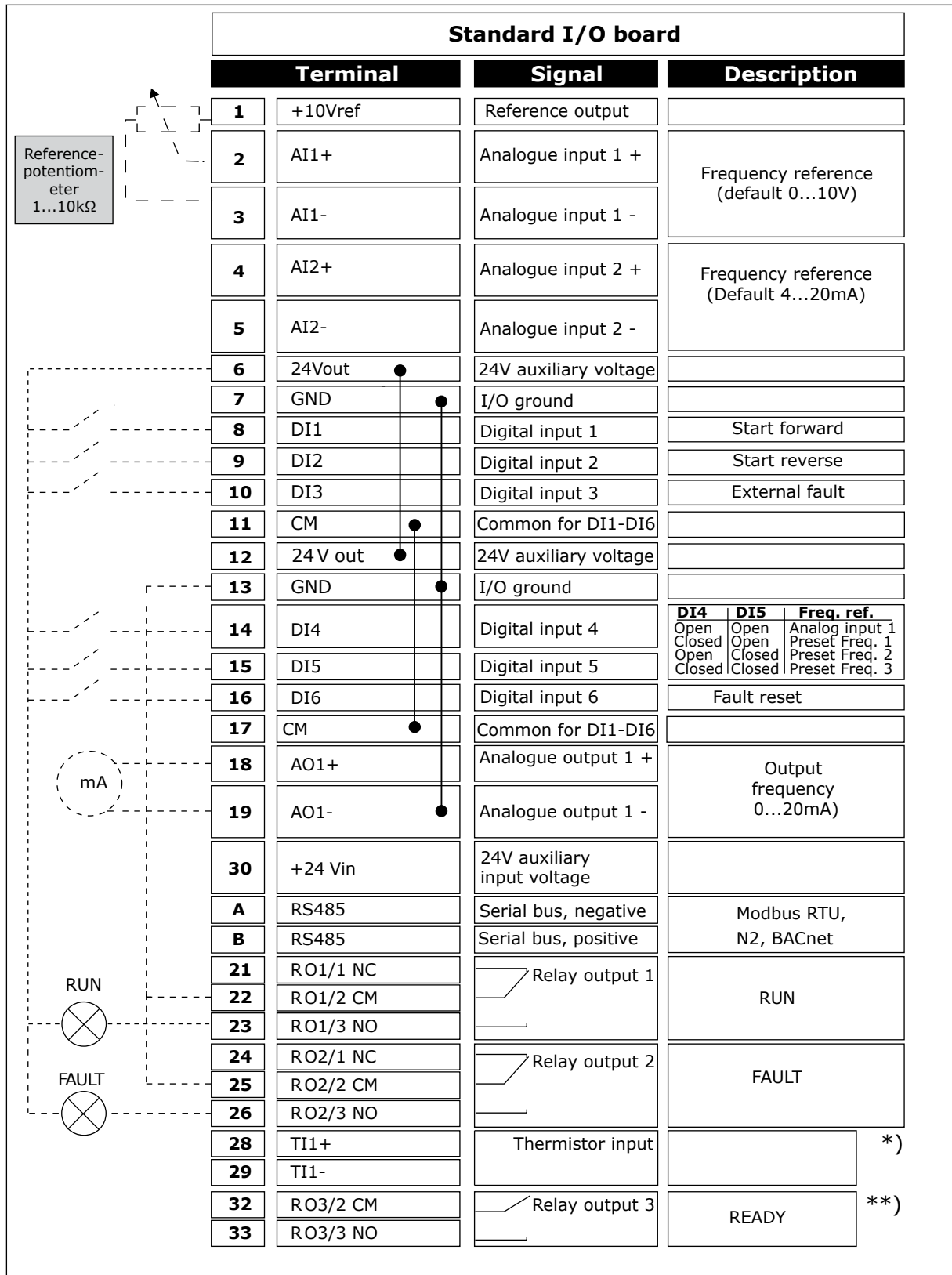

Fig. 4: The default control connections of Standard and HVAC applications

* = Available only in VACON® 100 X.

** = For the DIP switch configurations in VACON® 100 X, see the VACON 100® X Installation manual.

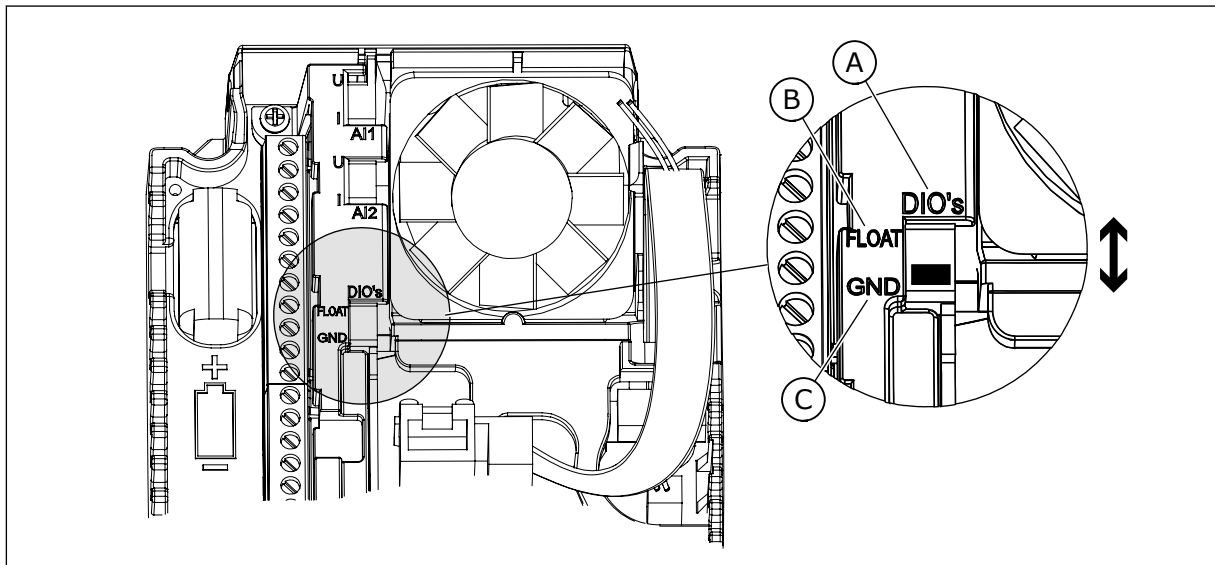

Fig. 5: The DIP switch

- A. Digital inputs
- B. Float

C. Connected to GND (default)

Table 2: M1.1 Wizards

Index	Parameter	Min	Max	Unit	Default	ID	Description
1.1.1	Startup Wizard	0	1		0	1170	0 = Do not activate 1 = Activate The selection Activate starts the Startup wizard (see Table 1 The Startup wizard).
1.1.2	Fire Mode Wizard	0	1		0	1672	The selection Activate starts the Fire mode wizard (see 2.6 Fire mode wizard).

Table 3: M1 Quick Setup

Index	Parameter	Min	Max	Unit	Default	ID	Description
1.2	Application	0	4		0	212	0 = Standard 1 = HVAC 2 = PID Control 3 = Multi-pump (single drive) 4 = Multi-pump (multi-drive)
1.3	Minimum Frequency Reference	0.00	P1.4	Hz	0.0	101	The minimum frequency reference that is accepted.
1.4	Maximum Frequency Reference	P1.3	320.0	Hz	50.0 / 60.0	102	The maximum frequency reference that is accepted.
1.5	Acceleration Time 1	0.1	3000.0	s	5.0	103	Gives the quantity of time that is necessary for the output frequency to increase from 0 frequency to the maximum frequency.
1.6	Deceleration Time 1	0.1	3000.0	s	5.0	104	Gives the quantity of time that is necessary for the output frequency to decrease from the maximum frequency to 0 frequency.
1.7	Motor Current Limit	I _H *0.1	I _S	A	Varies	107	The maximum motor current from the AC drive.
1.8	Motor Type	0	2		0	650	0 = Induction Motor 1 = Permanent Magnet Motor 2 = Reluctance Motor
1.9	Motor Nominal Voltage	Varies	Varies	V	Varies	110	Find this value U _n on the nameplate of the motor. NOTE! Find out if the motor connection is Delta or Star.

Table 3: M1 Quick Setup

Index	Parameter	Min	Max	Unit	Default	ID	Description
1.10	Motor Nominal Frequency	8.0	320.0	Hz	50 / 60	111	Find this value f_n on the nameplate of the motor.
1.11	Motor Nominal Speed	24	19200	Rpm	Varies	112	Find this value n_n on the nameplate of the motor.
1.12	Motor Nominal Current	$I_H * 0.1$	$I_H * 2$	A	Varies	113	Find this value I_n on the nameplate of the motor.
1.13	Motor Cos Phi (Power Factor)	0.30	1.00		Varies	120	Find this value on the nameplate of the motor.
1.14	Energy Optimisation	0	1		0	666	The drive finds the minimum motor current to use less energy and to lower the motor noise. Use this function with, for example, fan and pump processes. 0 = Disabled 1 = Enabled
1.15	Identification	0	2		0	631	The identification run calculates or measures the motor parameters that are necessary for a good control of the motor and speed. 0 = No action 1 = At standstill 2 = With rotation Before you do the identification run, you must set the motor nameplate parameters.
1.16	Start Function	0	1		0	505	0 = Ramping 1 = Flying Start
1.17	Stop Function	0	1		0	506	0 = Coasting 1 = Ramping

Table 3: M1 Quick Setup

Index	Parameter	Min	Max	Unit	Default	ID	Description
1.18	Automatic Reset	0	1		0	731	0 = Disabled 1 = Enabled
1.19	Response to External Fault	0	3		2	701	0 = No action 1 = Alarm 2 = Fault (Stop according to stop mode) 3 = Fault (Stop by coasting)
1.20	Response to AI Low Fault	0	5		0	700	0 = No action 1 = Alarm 2 = Alarm+preset fault frequency (P3.9.1.13) 3 = Alarm + previous frequency 4 = Fault (Stop according to stop mode) 5 = Fault (Stop by coasting)
1.21	Remote Control Place	0	1		0	172	The selection of the remote control place (start/stop). 0 = I/O control 1 = Fieldbus control

Table 3: M1 Quick Setup

Index	Parameter	Min	Max	Unit	Default	ID	Description
1.22	I/O Control Reference A Selection	0	20		5	117	<p>The selection of the frequency reference source when the control place is I/O A.</p> <p>0 = PC 1 = Preset Frequency 0 2 = Keypad Reference 3 = Fieldbus 4 = AI1 5 = AI2 5 = AI1+AI2 7 = PID Reference 8 = Motor Potentiometer 11 = Block Out.1 12 = Block Out.2 13 = Block Out.3 14 = Block Out.4 15 = Block Out.5 16 = Block Out.6 17 = Block Out.7 18 = Block Out.8 19 = Block Out.9 20 = Block Out.10</p> <p>The application that you set with parameter 1.2 gives the default value.</p>
1.23	Keypad Control Reference Selection	0	20		1	121	<p>The selection of the frequency reference source when the control place is keypad. See P1.22.</p>
1.24	Fieldbus Control Reference Selection	0	20		2	122	<p>The selection of the frequency reference source when the control place is fieldbus. See P1.22.</p>
1.25	AI1 Signal Range	0	1		0	379	<p>0= 0..10V / 0..20mA 1= 2..10V / 4..20mA</p>
1.26	AI2 Signal Range	0	1		1	390	<p>0= 0..10V / 0..20mA 1= 2..10V / 4..20mA</p>
1.27	R01 Function	0	74		2	11001	See P3.5.3.2.1
1.28	R02 Function	0	74		3	11004	See P3.5.3.2.1

Table 3: M1 Quick Setup

Index	Parameter	Min	Max	Unit	Default	ID	Description
1.29	R03 Function	0	74		1	11007	See P3.5.3.2.1
1.30	A01 Function	0	31		2	10050	See P3.5.4.1.1

Table 4: M1.31 Standard / M1.32 HVAC

Index	Parameter	Min	Max	Unit	Default	ID	Description
1.31.1	Preset Frequency 1	P1.3	P1.4	Hz	10.0	105	Make the selection of a preset frequency with the digital input DI4.
1.31.2	Preset Frequency 2	P1.3	P1.4	Hz	15.0	106	Make the selection of a preset frequency with the digital input DI5.
1.31.3	Preset Frequency 3	P1.3	P1.4	Hz	20.0	126	Make the selection of a preset frequency with the digital input DI4 and DI5.

1.4.2 PID CONTROL APPLICATION

You can use the PID control application with processes where you control the process variable, for example pressure, through the control of the speed of the motor.

In this application, the internal PID controller of the drive is configured for 1 setpoint and 1 feedback signal.

You can use 2 control places. Make the selection of the control place A or B with DI6. When control place A is active, DI1 gives the start and stop commands, and the PID controller gives the frequency reference. When control place B is active, DI4 gives the start and stop commands, and AI1 gives the frequency reference.

You can configure all the drive outputs freely in all the applications. There are 1 analogue output (Output Frequency) and 3 relay outputs (Run, Fault, Ready) available on the basic I/O board.

See the descriptions of the parameters in *Table 1 The Startup wizard*.

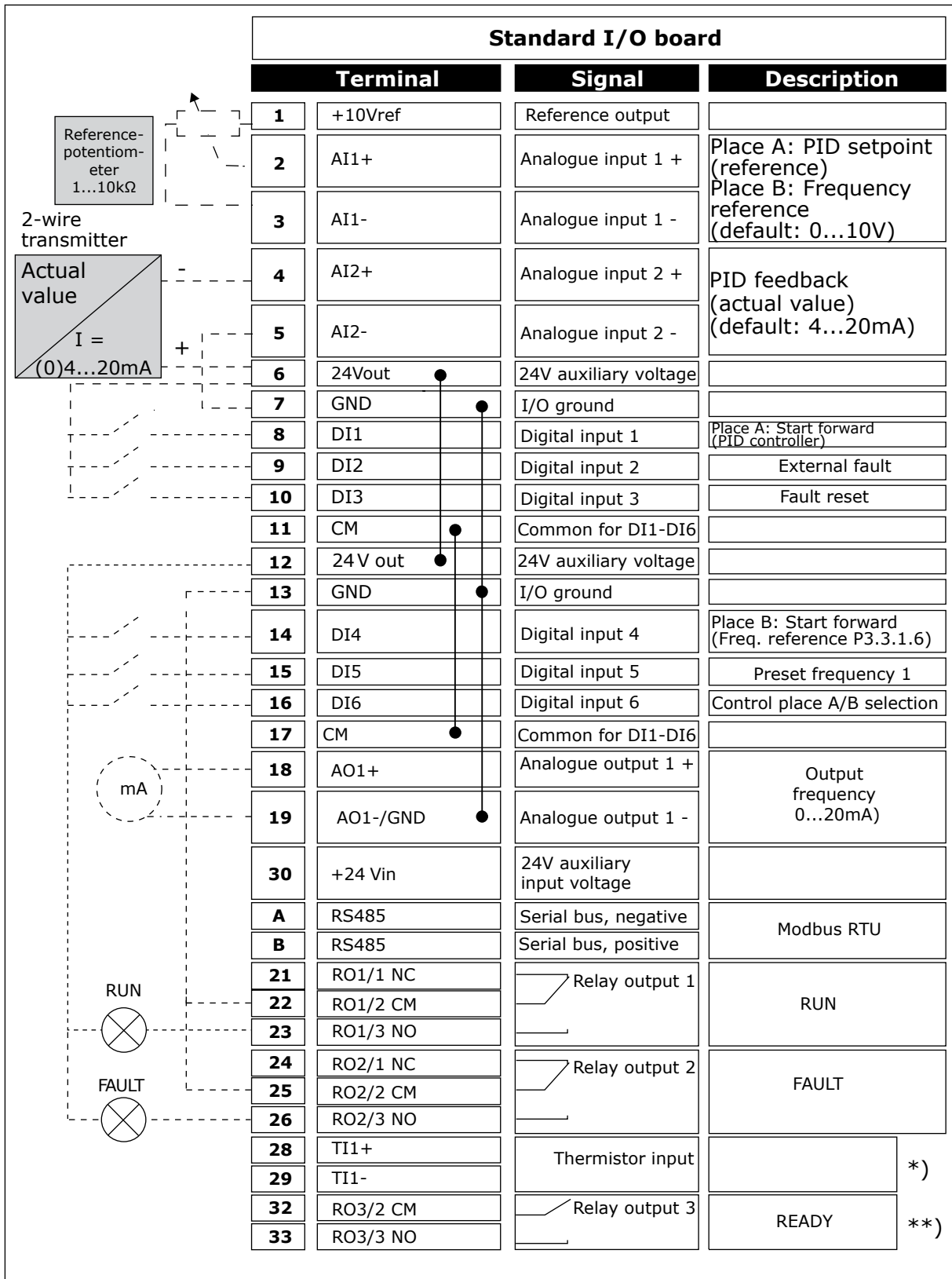

Fig. 6: The default control connections of the PID control application

* = Available only in VACON® 100 X.

** = For the DIP switch configurations in VACON® 100 X, see the VACON® 100 X Installation manual.

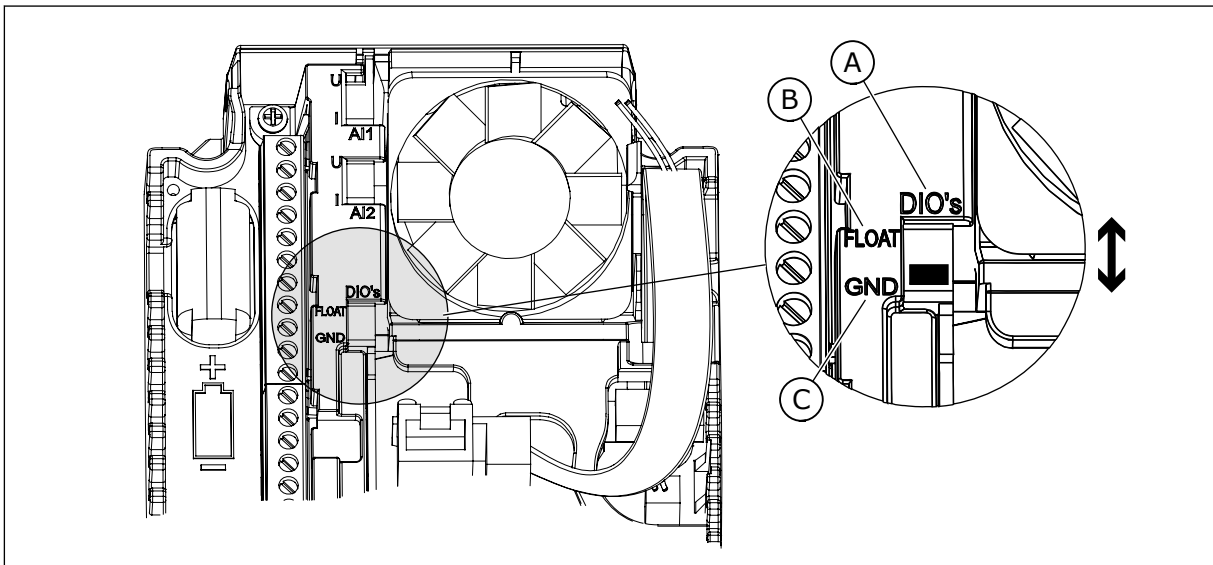

Fig. 7: The DIP switch

- A. Digital inputs
- B. Float

C. Connected to GND (default)

Table 5: M1.1 Wizards

Index	Parameter	Min	Max	Unit	Default	ID	Description
1.1.1	Startup Wizard	0	1		0	1170	0 = Do not activate 1 = Activate The selection Activate starts the Startup wizard (see 1.3 First startup).
1.1.2	Fire Mode Wizard	0	1		0	1672	The selection Activate starts the Fire mode wizard (see 2.6 Fire mode wizard).

Table 6: M1 Quick Setup

Index	Parameter	Min	Max	Unit	Default	ID	Description
1.2	Application	0	4		2	212	0 = Standard 1 = HVAC 2 = PID Control 3 = Multi-pump (single drive) 4 = Multi-pump (multi-drive)
1.3	Minimum Frequency Reference	0.00	P1.4	Hz	0.0	101	The minimum frequency reference that is accepted.
1.4	Maximum Frequency Reference	P1.3	320.0	Hz	50.0 / 60.0	102	The maximum frequency reference that is accepted.
1.5	Acceleration Time 1	0.1	3000.0	s	5.0	103	Gives the quantity of time that is necessary for the output frequency to increase from 0 frequency to the maximum frequency.
1.6	Deceleration Time 1	0.1	3000.0	s	5.0	104	Gives the quantity of time that is necessary for the output frequency to decrease from the maximum frequency to 0 frequency.
1.7	Motor Current Limit	I _H *0.1	I _S	A	Varies	107	The maximum motor current from the AC drive.
1.8	Motor Type	0	2		0	650	0 = Induction Motor 1 = Permanent Magnet Motor 2 = Reluctance Motor
1.9	Motor Nominal Voltage	Varies	Varies	V	Varies	110	Find this value U _n on the nameplate of the motor. NOTE! Find out if the motor connection is Delta or Star.

Table 6: M1 Quick Setup

Index	Parameter	Min	Max	Unit	Default	ID	Description
1.10	Motor Nominal Frequency	8.0	320.0	Hz	50.0 / 60.0	111	Find this value f_n on the nameplate of the motor.
1.11	Motor Nominal Speed	24	19200	Rpm	Varies	112	Find this value n_n on the nameplate of the motor.
1.12	Motor Nominal Current	$I_H * 0.1$	I_S	A	Varies	113	Find this value I_n on the nameplate of the motor.
1.13	Motor Cos Phi (Power Factor)	0.30	1.00		Varies	120	Find this value on the nameplate of the motor.
1.14	Energy Optimisation	0	1		0	666	The drive finds the minimum motor current to use less energy and to lower the motor noise. Use this function with, for example, fan and pump processes. 0 = Disabled 1 = Enabled
1.15	Identification	0	2		0	631	The identification run calculates or measures the motor parameters that are necessary for a good control of the motor and speed. 0 = No action 1 = At standstill 2 = With rotation Before you do the identification run, you must set the motor nameplate parameters.
1.16	Start Function	0	1		0	505	0 = Ramping 1 = Flying Start
1.17	Stop Function	0	1		0	506	0 = Coasting 1 = Ramping

Table 6: M1 Quick Setup

Index	Parameter	Min	Max	Unit	Default	ID	Description
1.18	Automatic Reset	0	1		0	731	0 = Disabled 1 = Enabled
1.19	Response to External Fault	0	3		2	701	0 = No action 1 = Alarm 2 = Fault (Stop according to stop mode) 3 = Fault (Stop by coasting)
1.20	Response to AI Low Fault	0	5		0	700	0 = No action 1 = Alarm 2 = Alarm+preset fault frequency (P3.9.1.13) 3 = Alarm + previous frequency 4 = Fault (stop according to stop mode) 5 = Fault (stop by coasting)
1.21	Remote Control Place	0	1		0	172	The selection of the remote control place (start/stop). 0 = I/O control 1 = Fieldbus control

Table 6: M1 Quick Setup

Index	Parameter	Min	Max	Unit	Default	ID	Description
1.22	I/O Control Reference A Selection	1	20		6	117	<p>The selection of the frequency reference source when the control place is I/O A.</p> <p>0 = PC 1 = Preset Frequency 0 2 = Keypad Reference 3 = Fieldbus 4 = AI1 5 = AI2 6 = AI1+AI2 7 = PID Reference 8 = Motor Potentiometer 11 = Block Out.1 12 = Block Out.2 13 = Block Out.3 14 = Block Out.4 15 = Block Out.5 16 = Block Out.6 17 = Block Out.7 18 = Block Out.8 19 = Block Out.9 20 = Block Out.10</p> <p>The application that you set with parameter 1.2 gives the default value.</p>
1.23	Keypad Control Reference Selection	1	20		1	121	See P1.22.
1.24	Fieldbus Control Reference Selection	1	20		2	122	See P1.22.
1.25	AI1 Signal Range	0	1		0	379	0= 0..10V / 0..20mA 1= 2..10V / 4..20mA
1.26	AI2 Signal Range	0	1		1	390	0= 0..10V / 0..20mA 1= 2..10V / 4..20mA
1.27	R01 Function	0	74		2	11001	See P3.5.3.2.1
1.28	R02 Function	0	74		3	11004	See P3.5.3.2.1
1.29	R03 Function	0	74		1	11007	See P3.5.3.2.1
1.30	A01 Function	0	31		2	10050	See P3.5.4.1.1

Table 7: M1.33 PID control

Index	Parameter	Min	Max	Unit	Default	ID	Description
1.33.1	PID Gain	0.00	100.00	%	100.00	118	If the value of the parameter is set to 100%, a change of 10% in the error value causes the controller output to change by 10%.
1.33.2	PID Integration Time	0.00	600.00	s	1.00	119	If this parameter is set to, 1,00 s, a change of 10% in the error value causes the controller output to change by 10.00%/s.
1.33.3	PID Derivation Time	0.00	100.00	s	0.00	1132	If this parameter is set to, 1,00 s, a change of 10% in the error value during 1.00 s causes the controller output to change by 10.00%.
1.33.4	Process Unit Selection	1	44		1	1036	Select the unit of the process. See P3.13.1.4
1.33.5	Process Unit Min	Varies	Varies		Varies	1033	The process unit value that is the same as 0% of the PID feedback signal.
1.33.6	Process Unit Max	Varies	Varies		Varies	1034	The process unit value that is the same as 100% of the PID feedback signal.
1.33.7	Feedback 1 Source Selection	0	30		2	334	See P3.13.3.3
1.33.8	Setpoint 1 Source Selection	0	32		1	332	See P3.13.2.6
1.33.9	Keypad Setpoint 1	Varies	Varies	Varies	0	167	
1.33.10	SP1 Sleep Frequency Limit	0.0	320.0	Hz	0.0	1016	The drive goes to the sleep mode when the output frequency stays below this limit for longer than is specified by parameter Sleep Delay. 0 = Not used

Table 7: M1.33 PID control

Index	Parameter	Min	Max	Unit	Default	ID	Description
1.33.11	SP1 Sleep Delay	0	3000	s	0	1017	The minimum quantity of time that the frequency stays below the sleep level before the drive stops. 0 = Not used
1.33.12	SP1 Wake Up Level	Varies	Varies	Varies	Varies	1018	The wake-up value of the PID feedback supervision. Wake-up Level 1 uses the selected process units. 0 = Not used
1.33.12	Preset Frequency 1	P1.3	P1.4	Hz	10.0	105	The preset frequency that the the digital input DI5 selects.

1.4.3 MULTI-PUMP (SINGLE DRIVE) APPLICATION

You can use Multi-pump (single drive) application in applications, where 1 drive controls a system that has the maximum of 8 parallel motors, for example, pumps, fans or compressors. By default, Multi-pump (single drive) application is configured for 3 parallel motors.

The drive is connected to 1 of the motors, which becomes the regulating motor. The internal PID controller of the drive controls the speed of the regulating motor and gives control signals by relay outputs to start or stop the auxiliary motors. External contactors (switch) set the auxiliary motors to the mains.

You can control a process variable, the pressure for example, by the control of the speed of the regulating motor and by the number of motors that operate.

See the descriptions of the parameters in *10 Parameter descriptions*.

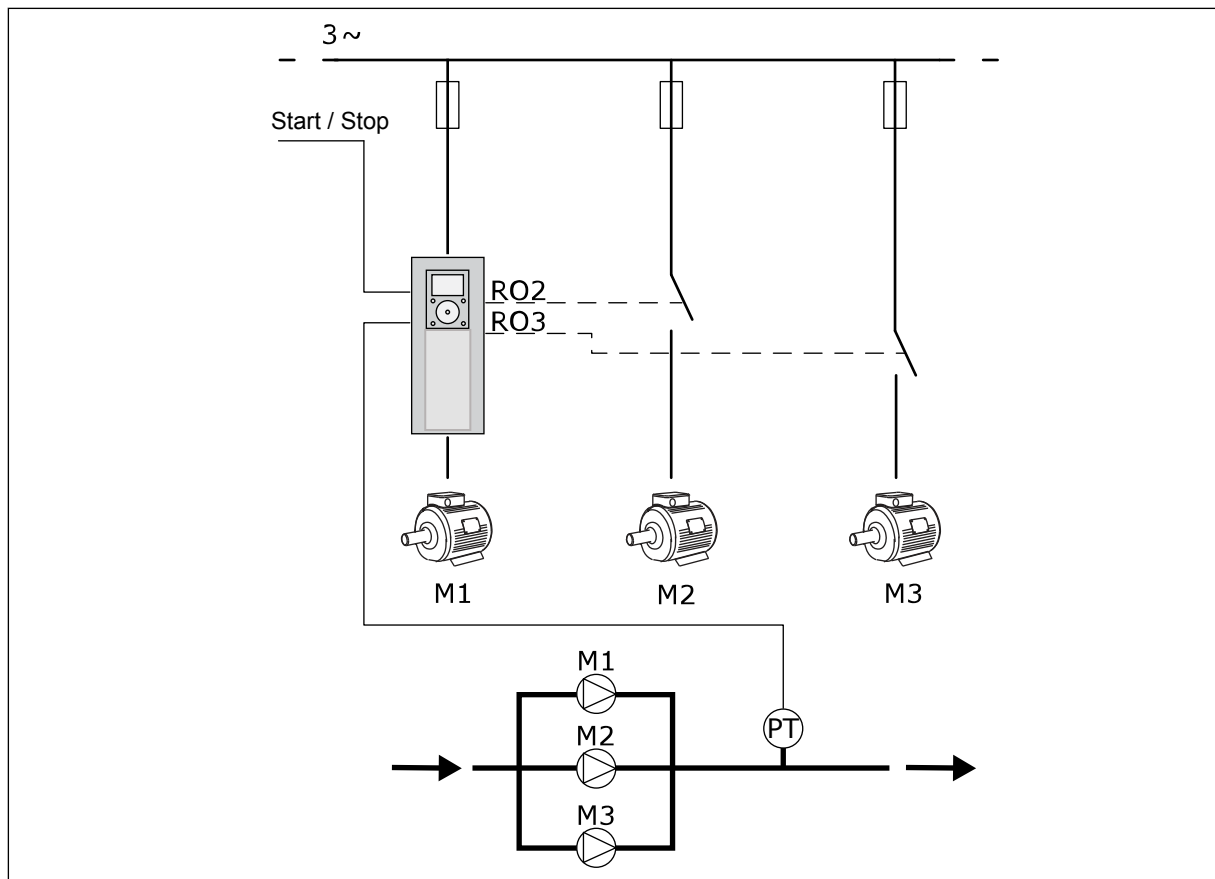

Fig. 8: Multi-pump (single drive) configuration

Autochange function (change of start order) makes the wear of the motors in the system more equal. Autochange function monitors the running hours and sets the start order of each motor. The motor that has the lowest running hours starts first and the motor that has the highest running hours starts last. You can configure the autochange to start based on the autochange interval time set by the internal real time clock (an RTC battery needed) of the drive.

You can configure the autochange for all the motors in the system or only the auxiliary motors.

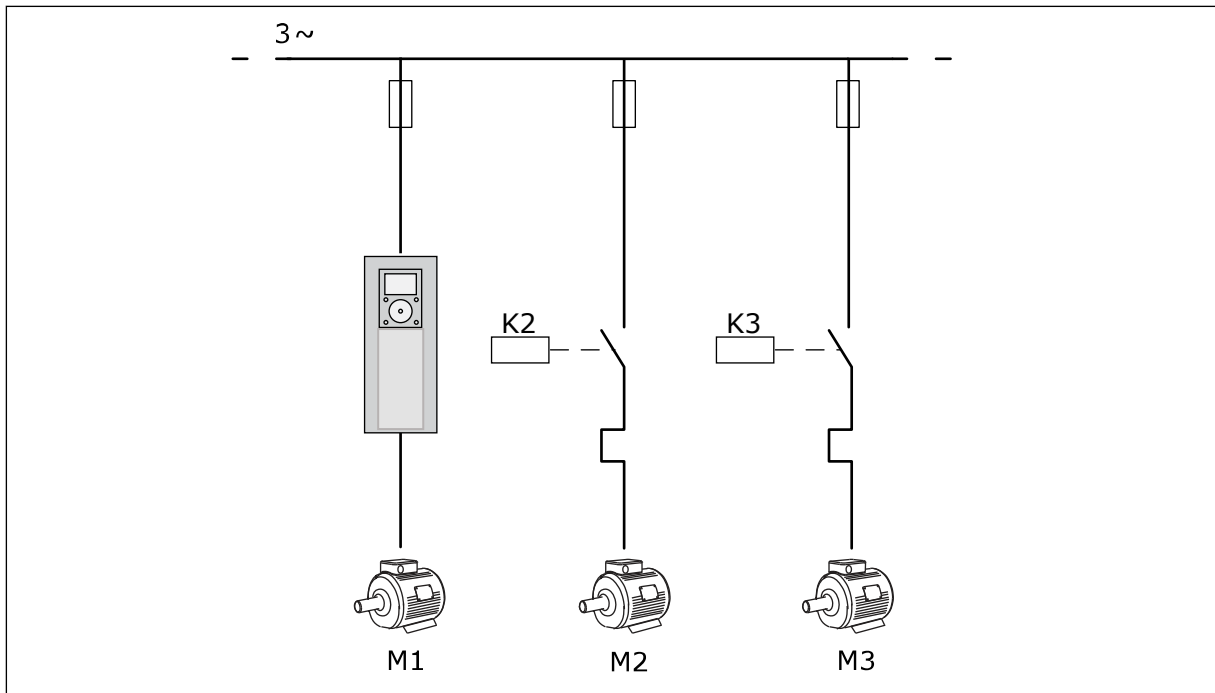

Fig. 9: Control diagram, where only the auxiliary motors are configured to autochange

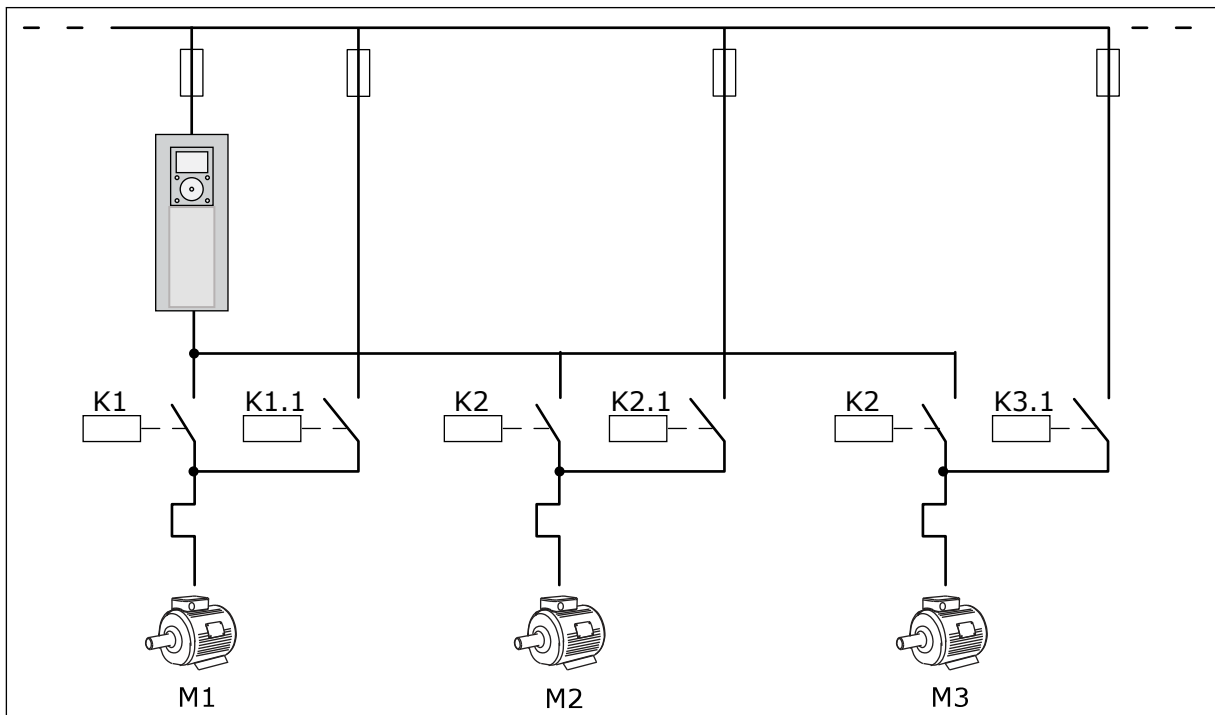

Fig. 10: Control diagram, where all the motors are configured to autochange

You can use 2 control places. Make the selection of the control place A or B with DI6. When control place Make the selection of the control place A or B with DI6. When control place A is active, DI1 gives the start and stop commands, and the PID controller gives the frequency reference. When control place B is active, DI4 gives the start and stop commands, and AI1 gives the frequency reference.

You can configure all the drive outputs freely in all the applications. There are 1 analogue output (Output Frequency) and 3 relay outputs (Run, Fault, Ready) available on the basic I/O board.

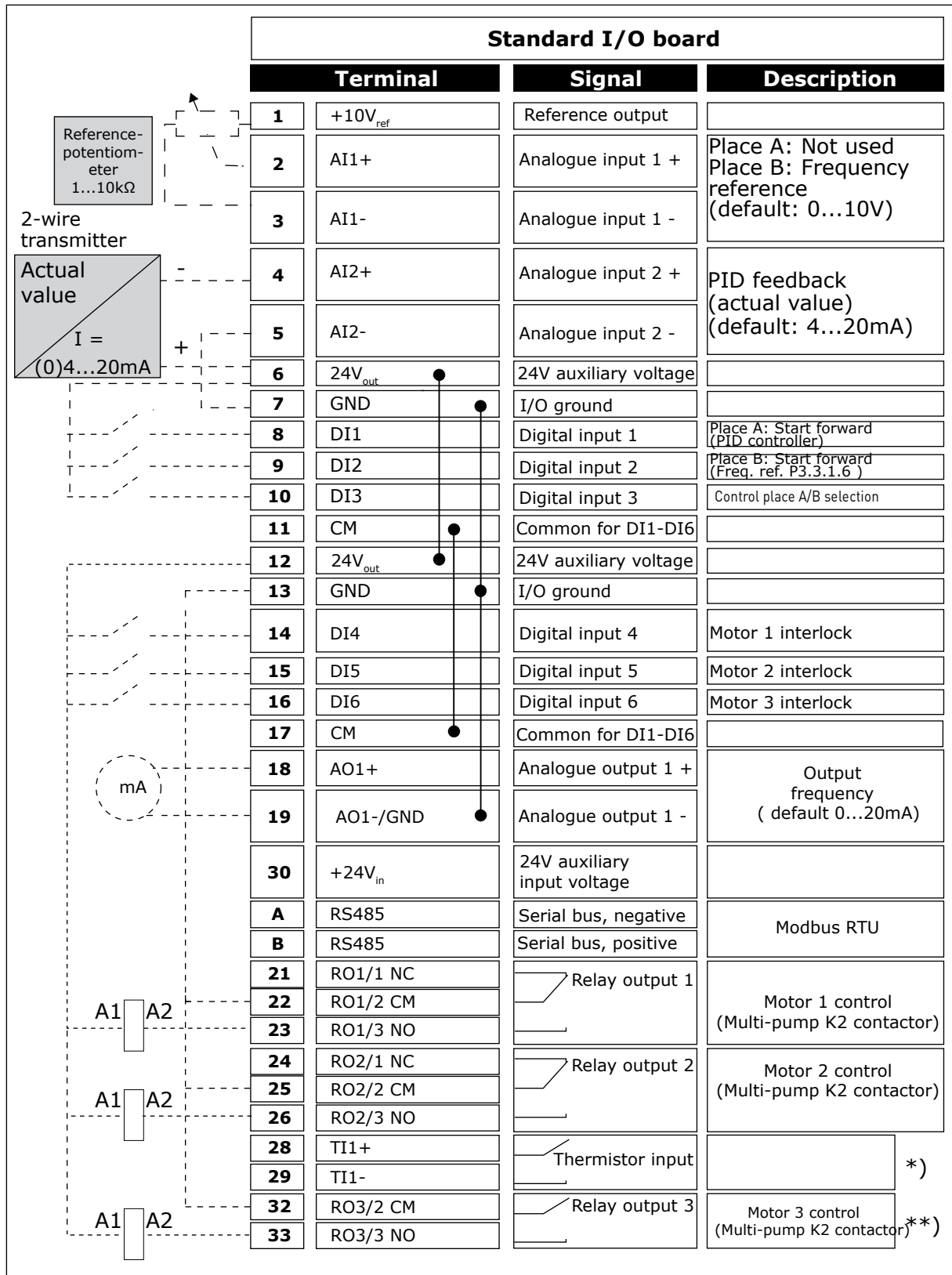

Fig. 11: The default control connections of Multi-pump (single drive) application

* = Available only in VACON® 100 X.

** = For the DIP switch configurations in VACON® 100 X, see the VACON® 100 X Installation manual.

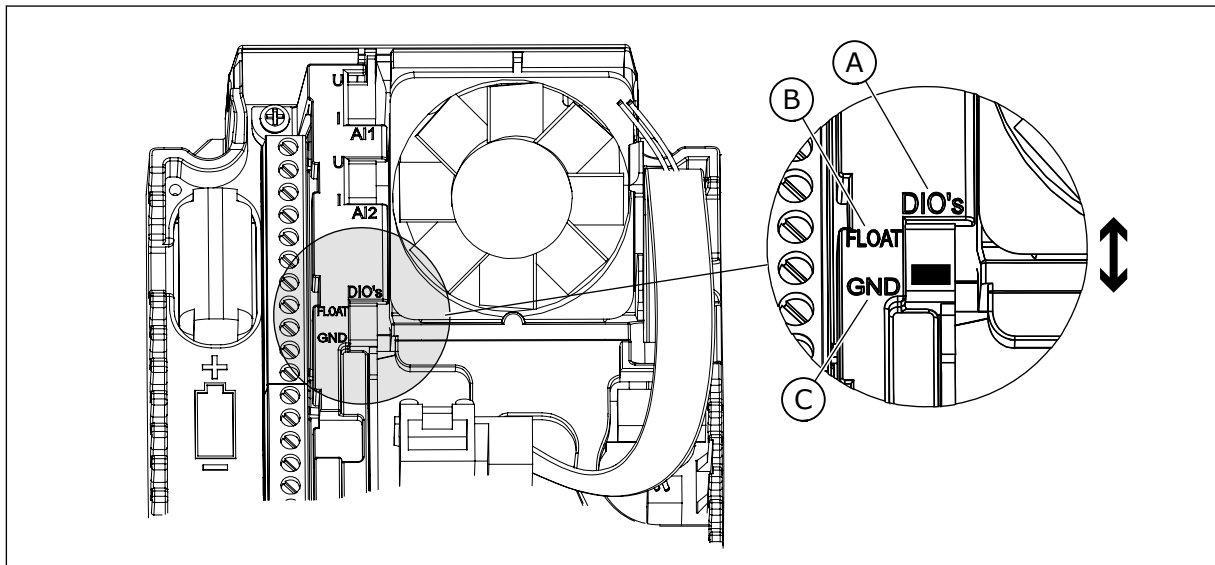

Fig. 12: The DIP switch

- A. Digital inputs
- B. Float

C. Connected to GND (default)

Table 8: M1.1 Wizards

Index	Parameter	Min	Max	Unit	Default	ID	Description
1.1.1	Startup Wizard	0	1		0	1170	0 = Do not activate 1 = Activate The selection Activate starts the Startup wizard (see 1.3 First startup).
1.1.2	Fire Mode Wizard	0	1		0	1672	The selection Activate starts the Fire mode wizard (see 2.6 Fire mode wizard).

Table 9: M1 Quick Setup

Index	Parameter	Min	Max	Unit	Default	ID	Description
1.2	Application	0	4		2	212	0 = Standard 1 = HVAC 2 = PID Control 3 = Multi-pump (single drive) 4 = Multi-pump (multi-drive)
1.3	Minimum Frequency Reference	0.00	P1.4	Hz	0.0	101	The minimum frequency reference that is accepted.
1.4	Maximum Frequency Reference	P1.3	320.0	Hz	50.0 / 60.0	102	The maximum frequency reference that is accepted.
1.5	Acceleration Time 1	0.1	3000.0	s	5.0	103	Gives the quantity of time that is necessary for the output frequency to increase from 0 frequency to the maximum frequency.
1.6	Deceleration Time 1	0.1	3000.0	s	5.0	104	Gives the quantity of time that is necessary for the output frequency to decrease from the maximum frequency to 0 frequency.
1.7	Motor Current Limit	I _H *0.1	I _S	A	Varies	107	The maximum motor current from the AC drive.
1.8	Motor Type	0	2		0	650	0 = Induction Motor 1 = Permanent Magnet Motor 2 = Reluctance Motor
1.9	Motor Nominal Voltage	Varies	Varies	V	Varies	110	Find this value U _n on the nameplate of the motor. NOTE! Find out if the motor connection is Delta or Star.

Table 9: M1 Quick Setup

Index	Parameter	Min	Max	Unit	Default	ID	Description
1.10	Motor Nominal Frequency	8.0	320.0	Hz	50.0 / 60.0	111	Find this value f_n on the nameplate of the motor.
1.11	Motor Nominal Speed	24	19200	Rpm	Varies	112	Find this value n_n on the nameplate of the motor.
1.12	Motor Nominal Current	$I_H * 0.1$	I_S	A	Varies	113	Find this value I_n on the nameplate of the motor.
1.13	Motor Cos Phi (Power Factor)	0.30	1.00		Varies	120	Find this value on the nameplate of the motor.
1.14	Energy Optimisation	0	1		0	666	The drive finds the minimum motor current to use less energy and to lower the motor noise. Use this function with, for example, fan and pump processes. 0 = Disabled 1 = Enabled
1.15	Identification	0	2		0	631	The identification run calculates or measures the motor parameters that are necessary for a good control of the motor and speed. 0 = No action 1 = At standstill 2 = With rotation Before you do the identification run, you must set the motor nameplate parameters.
1.16	Start Function	0	1		0	505	0 = Ramping 1 = Flying Start
1.17	Stop Function	0	1		0	506	0 = Coasting 1 = Ramping

Table 9: M1 Quick Setup

Index	Parameter	Min	Max	Unit	Default	ID	Description
1.18	Automatic Reset	0	1		0	731	0 = Disabled 1 = Enabled
1.19	Response to External Fault	0	3		2	701	0 = No action 1 = Alarm 2 = Fault (Stop according to stop mode) 3 = Fault (Stop by coasting)
1.20	Response to AI Low Fault	0	5		0	700	0 = No action 1 = Alarm 2 = Alarm+preset fault frequency (P3.9.1.13) 3 = Alarm + previous frequency 4 = Fault (stop according to stop mode) 5 = Fault (stop by coasting)
1.21	Remote Control Place	0	1		0	172	The selection of the remote control place (start/stop). 0 = I/O control 1 = Fieldbus control

Table 9: M1 Quick Setup

Index	Parameter	Min	Max	Unit	Default	ID	Description
1.22	I/O Control Reference A Selection	1	20		6	117	<p>The selection of the frequency reference source when the control place is I/O A.</p> <p>0 = PC 1 = Preset Frequency 0 2 = Keypad Reference 3 = Fieldbus 4 = AI1 5 = AI2 6 = AI1+AI2 7 = PID Reference 8 = Motor Potentiometer 11 = Block Out.1 12 = Block Out.2 13 = Block Out.3 14 = Block Out.4 15 = Block Out.5 16 = Block Out.6 17 = Block Out.7 18 = Block Out.8 19 = Block Out.9 20 = Block Out.10</p> <p>The application that you set with parameter 1.2 gives the default value.</p>
1.23	Keypad Control Reference Selection	1	20		1	121	See P1.22.
1.24	Fieldbus Control Reference Selection	1	20		2	122	See P1.22.
1.25	AI1 Signal Range	0	1		0	379	0= 0..10V / 0..20mA 1= 2..10V / 4..20mA
1.26	AI2 Signal Range	0	1		1	390	0= 0..10V / 0..20mA 1= 2..10V / 4..20mA
1.27	R01 Function	0	74		2	11001	See P3.5.3.2.1
1.28	R02 Function	0	74		3	11004	See P3.5.3.2.1
1.29	R03 Function	0	74		1	11007	See P3.5.3.2.1
1.30	A01 Function	0	31		2	10050	See P3.5.4.1.1

Table 10: M1.34 Multi-pump (single drive)

Index	Parameter	Min	Max	Unit	Default	ID	Description
1.34.1	PID Gain	0.00	100.00	%	100.00	118	If the value of the parameter is set to 100%, a change of 10% in the error value causes the controller output to change by 10%.
1.34.2	PID Integration Time	0.00	600.00	s	1.00	119	If this parameter is set to 1,00 s, a change of 10% in the error value causes the controller output to change by 10.00%/s.
1.34.3	PID Derivation Time	0.00	100.00	s	0.00	1132	If this parameter is set to 1,00 s, a change of 10% in the error value during 1.00 s causes the controller output to change by 10.00%.
1.34.4	Process Unit Selection	1	44		1	1036	Select the unit of the process. See P3.13.1.4
1.34.5	Process Unit Min	Varies	Varies		Varies	1033	The process unit value that is the same as 0% of the PID feedback signal.
1.34.6	Process Unit Max	Varies	Varies		Varies	1034	The process unit value that is the same as 100% of the PID feedback signal.
1.34.7	Feedback 1 Source Selection	0	30		2	334	See P3.13.3.3
1.34.8	Setpoint 1 Source Selection	0	32		1	332	See P3.13.2.6
1.34.9	Keypad Setpoint 1	Varies	Varies	Varies	0	167	

Table 10: M1.34 Multi-pump (single drive)

Index	Parameter	Min	Max	Unit	Default	ID	Description
1.34.10	SP1 Sleep Frequency Limit	0.0	320.0	Hz	0.0	1016	The drive goes to the sleep mode when the output frequency stays below this limit for longer than is specified by parameter Sleep Delay. 0 = Not used
1.34.11	SP1 Sleep Delay	0	3000	s	0	1017	The minimum quantity of time that the frequency stays below the sleep level before the drive stops. 0 = Not used
1.34.12	SP1 Wake Up Level	Varies	Varies	Varies	Varies	1018	The wake-up value of the PID feedback supervision. Wake-up Level 1 uses the selected process units. 0 = Not used
1.34.13	Multi-pump Mode	0	2		0	1785	Selects the Multi-pump mode. 0= Single drive 1= Multifollower 2= Multimaster
1.34.14	Number of Pumps	1	8		1	1001	Total number of motors (pumps/fans) used in the Multi-pump system.
1.34.15	Pump Interlocking	0	1		1	1032	Enable/Disable interlocks. Interlocks tell the system if a motor is connected or not. 0 = Disabled 1 = Enabled

Table 10: M1.34 Multi-pump (single drive)

Index	Parameter	Min	Max	Unit	Default	ID	Description
1.34.16	Autochange	0	2		1	1027	Disable/enable the rotation of the start order and the priority of the motors. 0 = Disabled 1 = Enabled (interval) 2 = Enabled (week-days)
1.34.17	Autochanged Pump	0	1		1	1028	0 = Auxiliary Pump 1 = All Pumps
1.34.18	Autochange Interval	0.0	3000.0	h	48.0	1029	When the time specified by the this parameter is used, the autochange function starts. But the autochange starts only if the capacity is below the level specified by parameters P1.34.21 and P1.34.22.
1.34.19	Autochange Days	0	127			15904	Range B0 = Sunday B1 = Monday B2 = Tuesday B3 = Wednesday B4 = Thursday B5 = Friday B6 = Saturday
1.34.20	Autochange Time of Day	00:00:00	23:59:59	Time		15905	Range: 00:00:00-23:59:59
1.34.21	Autochange: Frequency Limit	0.00	P3.3.1.2	Hz	25:00	1031	These parameters set the level below which the capacity must stay for the autochange to start.
1.34.22	Autochange: Pump Limit	1	6			1030	

Table 10: M1.34 Multi-pump (single drive)

Index	Parameter	Min	Max	Unit	Default	ID	Description
1.34.23	Bandwidth	0	100	%	10	1097	The percent of the setpoint. For example, Setpoint = 5 bar Bandwidth = 10% When the feedback value stays between 4.5 and 5.5 bar, the motor stays connected.
1.34.24	Bandwidth Delay	0	3600	s	10	1098	When the feedback is outside the bandwidth, the time after which pumps are added or removed.
1.34.25	Pump 1 Interlock				DigIN Slot0.1	426	OPEN = Not active CLOSED = Active
1.34.26	Pump 2 Interlock				DigIN Slot0.1	427	See 1.34.25
1.34.27	Pump 3 Interlock				DigIN Slot0.1	428	See 1.34.25
1.34.28	Pump 4 Interlock				DigIN Slot0.1	429	See 1.34.25
1.34.29	Pump 5 Interlock				DigIN Slot0.1	430	See 1.34.25
1.34.30	Pump 6 Interlock				DigIN Slot0.1	486	See 1.34.25
1.34.31	Pump 7 Interlock				DigIN Slot0.1	487	See 1.34.25
1.34.32	Pump 8 Interlock				DigIN Slot0.1	488	See 1.34.25

1.4.4 MULTI-PUMP (MULTIDRIVE) APPLICATION

You can use the Multi-pump (multidrive) application in a system that has the maximum of 8 parallel speed motors with different speeds, for example, pumps, fans or compressors. By default, the Multi-pump (Multidrive) application is configured for 3 parallel motors.

See the descriptions of the parameters in *10 Parameter descriptions*.

The checklist for the commissioning a Multi-pump (multidrive) system is in *10.16.1 Multi-pump (multidrive) commissioning checklist*.

Each motor has a drive controls that applicable motor. The drives of the system communicate with each other by Modbus RTU communication.

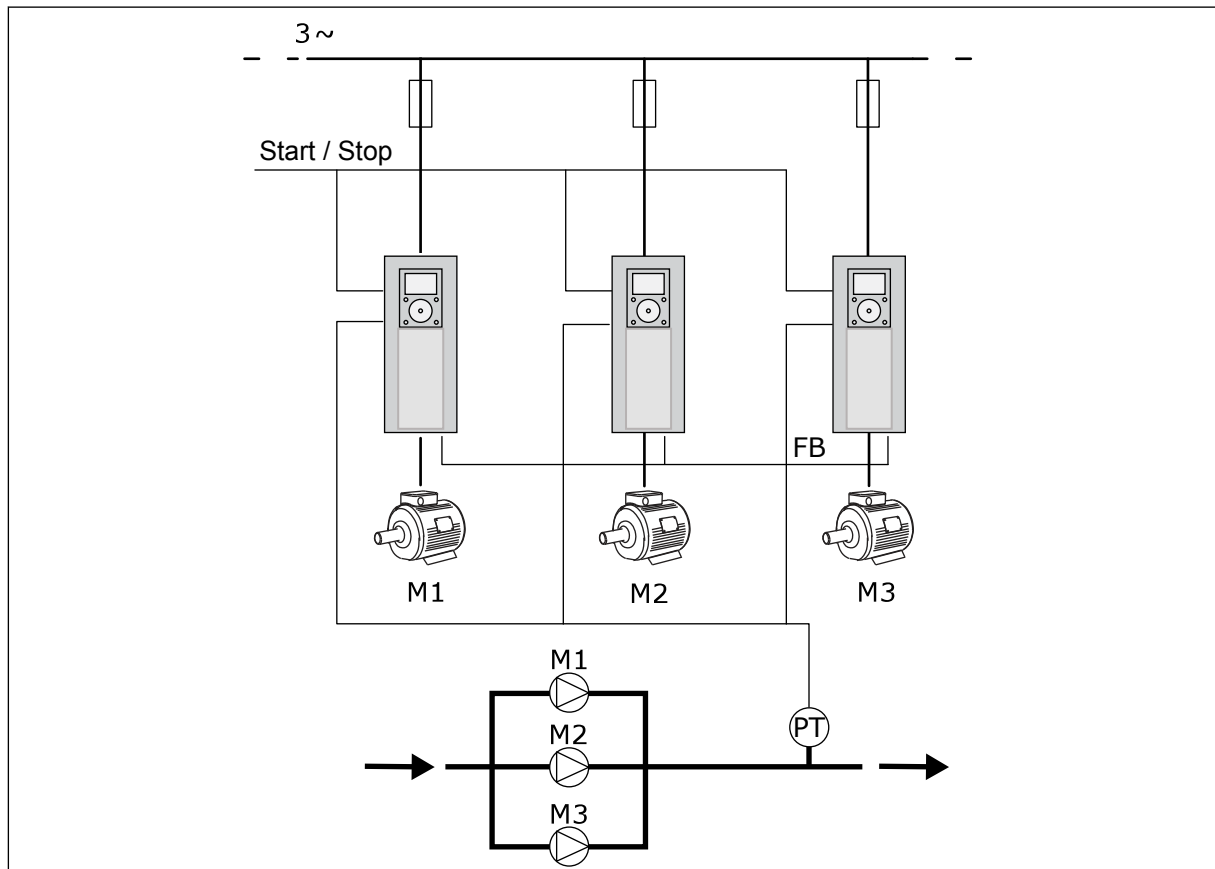

Fig. 13: Multi-pump (multidrive) configuration

You can control a process variable, the pressure for example, by the control of the speed of the regulating motor and by the number of motors that operate. The internal PID controller in the drive of the regulating motor controls the speed, the start and stop of the motors.

The operation of the system is specified by the selected operation mode. In the Multifollower mode, auxiliary motors follow the speed of the regulating motor.

Pump 1 controls and pumps 2 and 3 follow the speed of pump 1, as the curves A show.

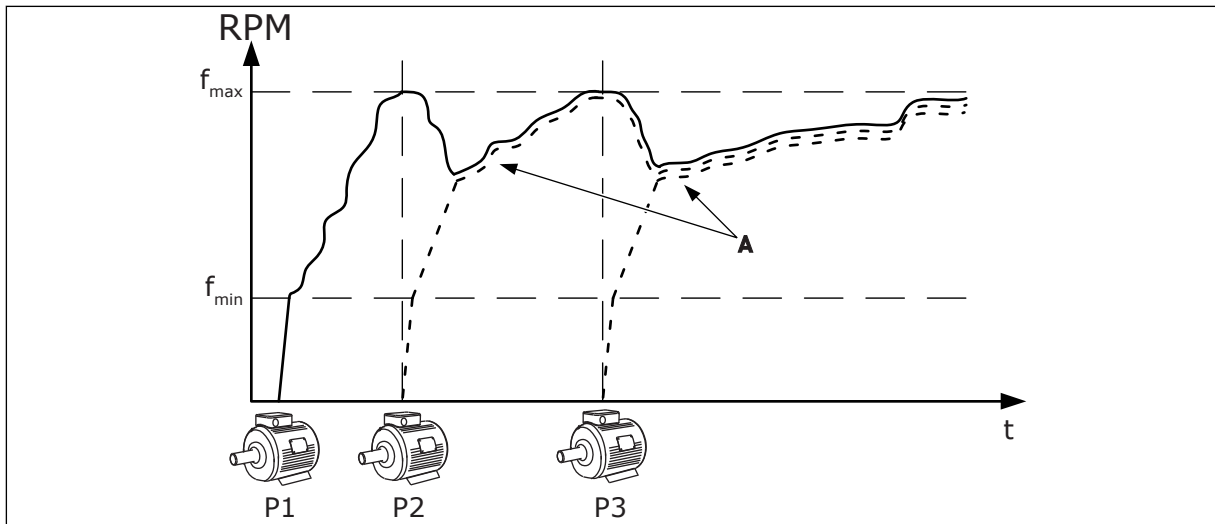

Fig. 14: Control in the Multifollower mode

The figure below shows an example of the Multimaster mode, where the speed of the regulating motor locks to the constant production speed B, when next motor starts. Curves A show the regulating of the pumps.

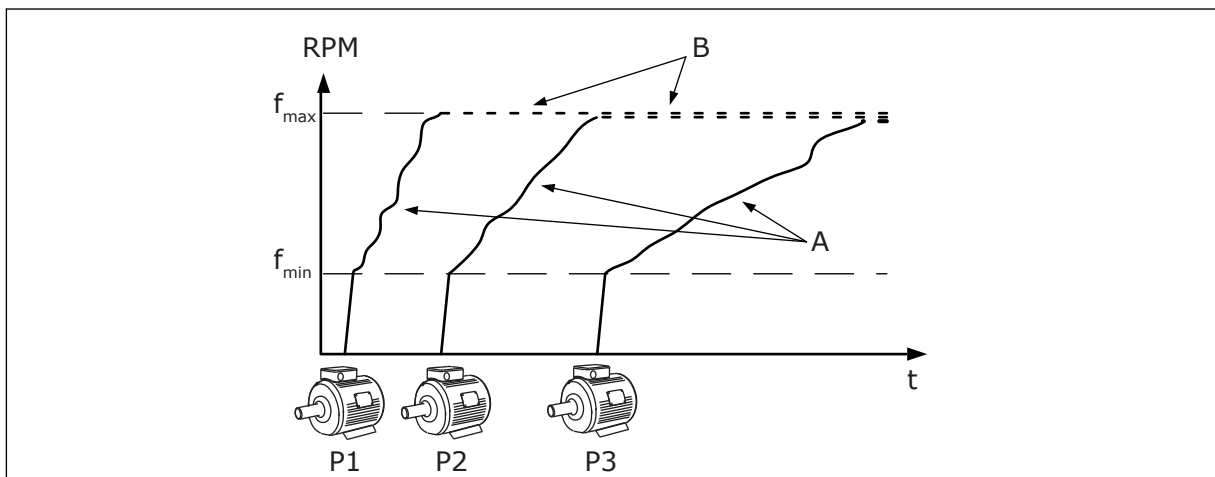

Fig. 15: Control in the Multimaster mode

Autochange function (change of start order) makes the wear of the motors in the system more equal. Autochange function monitors the running hours and sets the start order of each motor. The motor that has the lowest running hours starts first and the motor that has the highest running hours starts last. You can configure the autochange to start based on the autochange interval time or on the internal real time clock of the drive (an RTC battery needed).

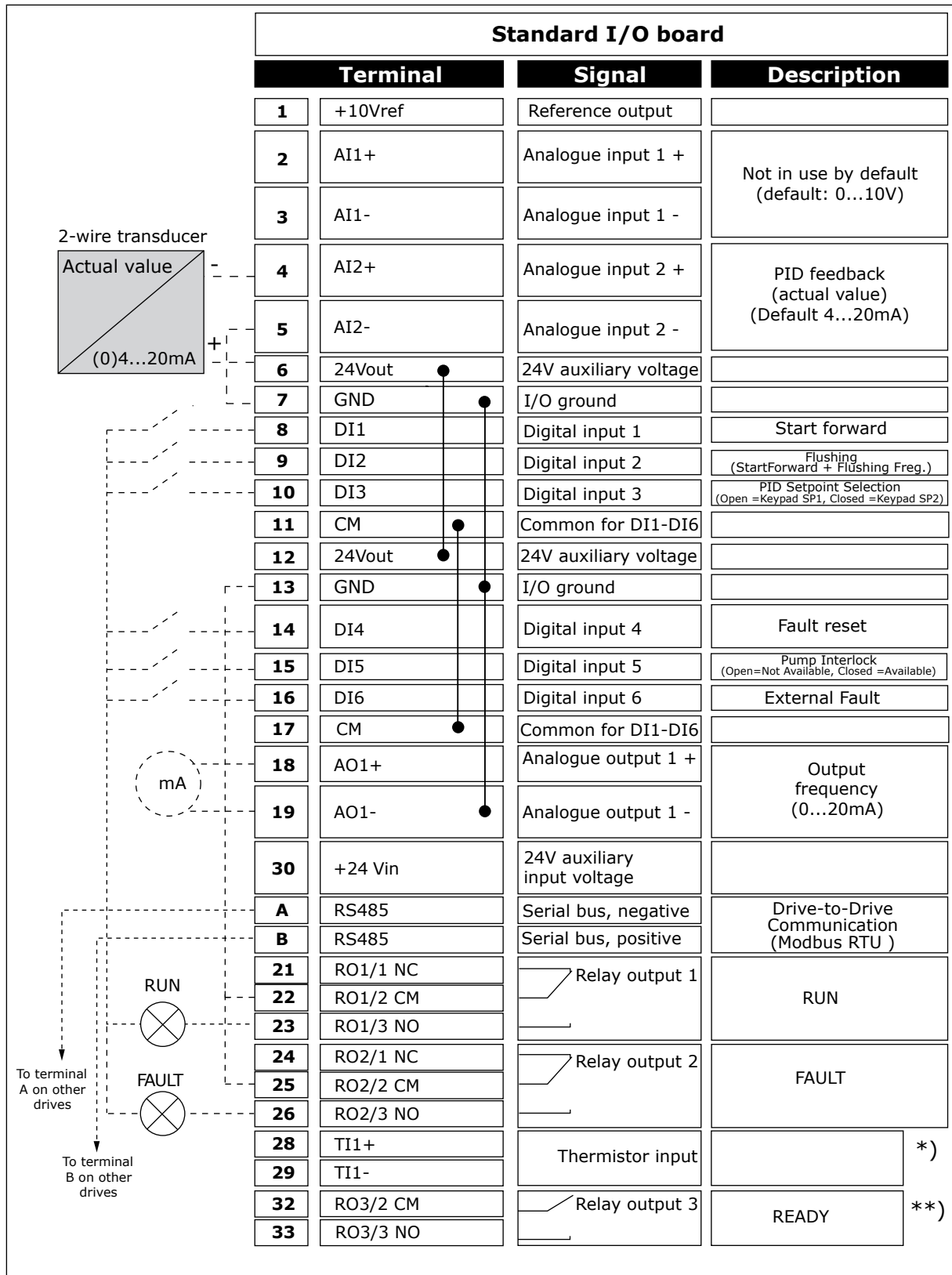

Fig. 16: The default control connections of Multi-pump (multidrive) application

* = Available only in VACON® 100 X.

** = For the DIP switch configurations in Vacon VACON® X, see the VACON® 100 X Installation manual.

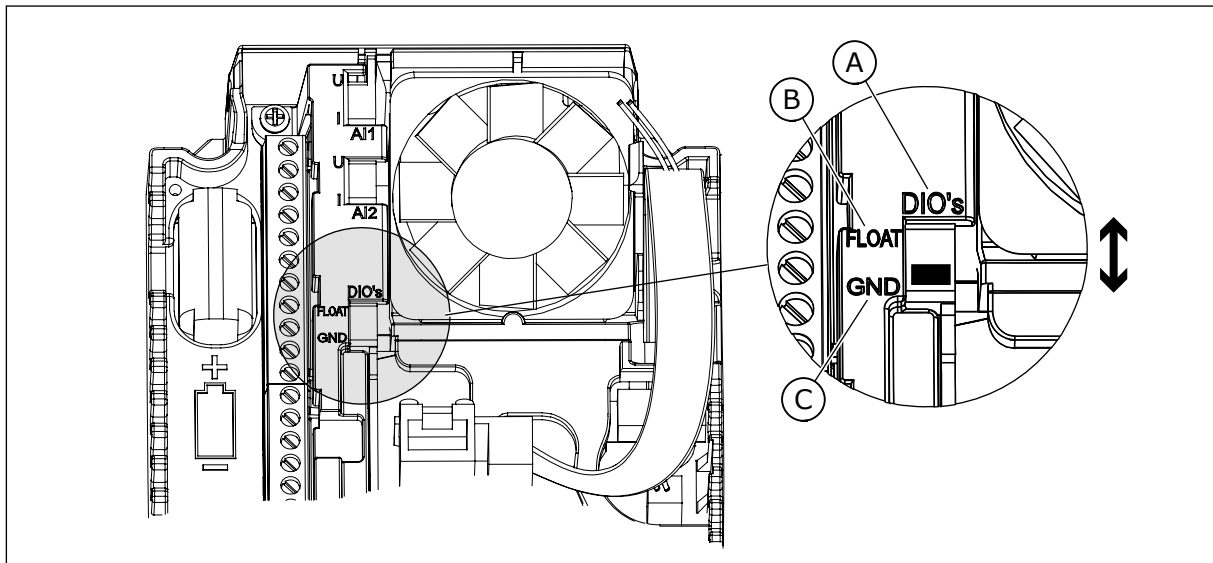

Fig. 17: The DIP switch

A. Digital inputs
B. Float

C. Connected to GND (default)

Each drive has a pressure sensor. When the redundancy level is high, the drive and the pressure sensors are redundant.

- If there is a drive failure, the next drive starts to operate as master.
- If there is a sensor failure, the next drive (that has a separate sensor) starts to operate as master.

An individual switch that has an auto, off and man setting controls each drive.

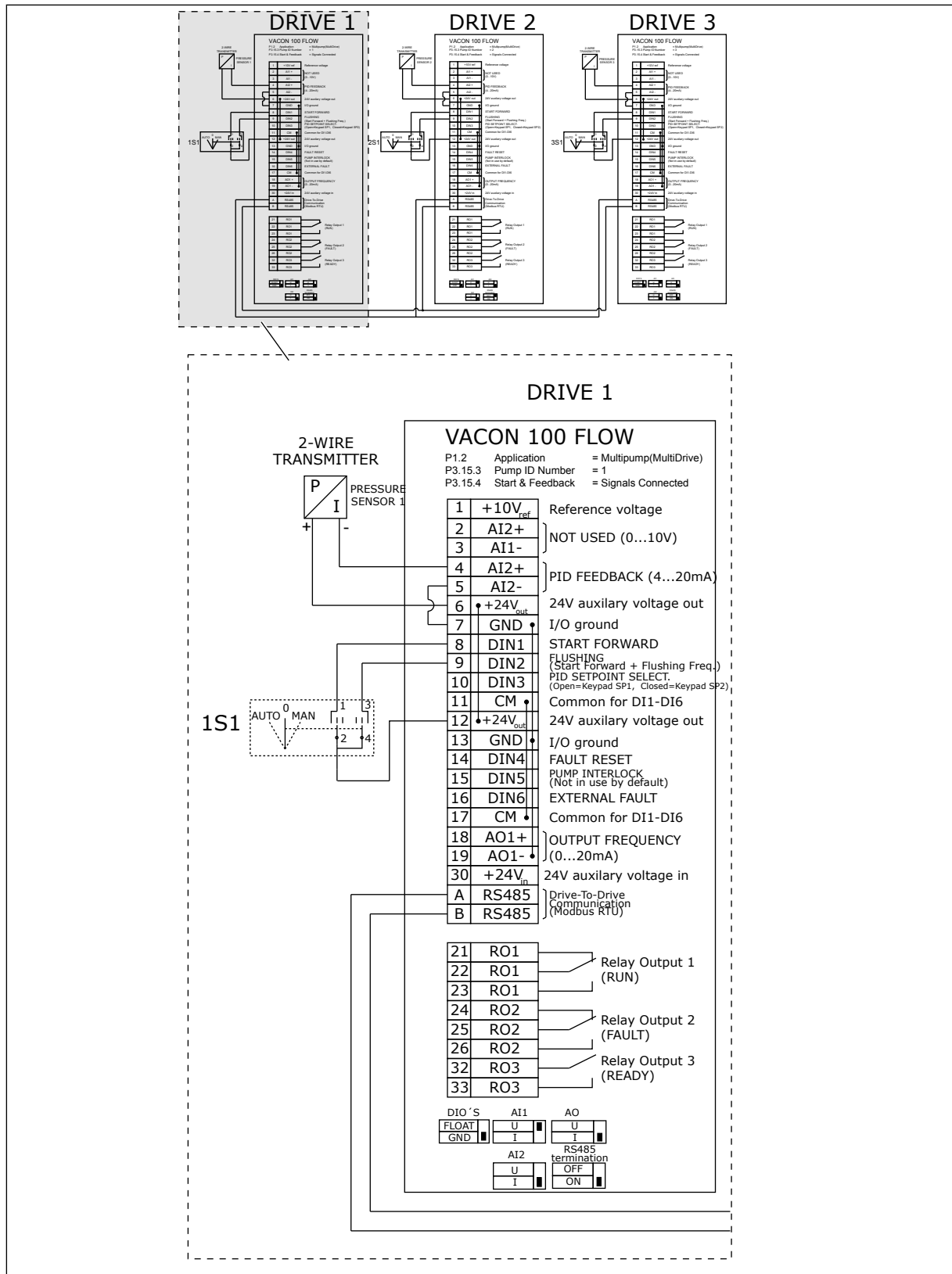

Fig. 18: Electric wiring diagramme of the Multi-pump (multidrive) system, example 1A

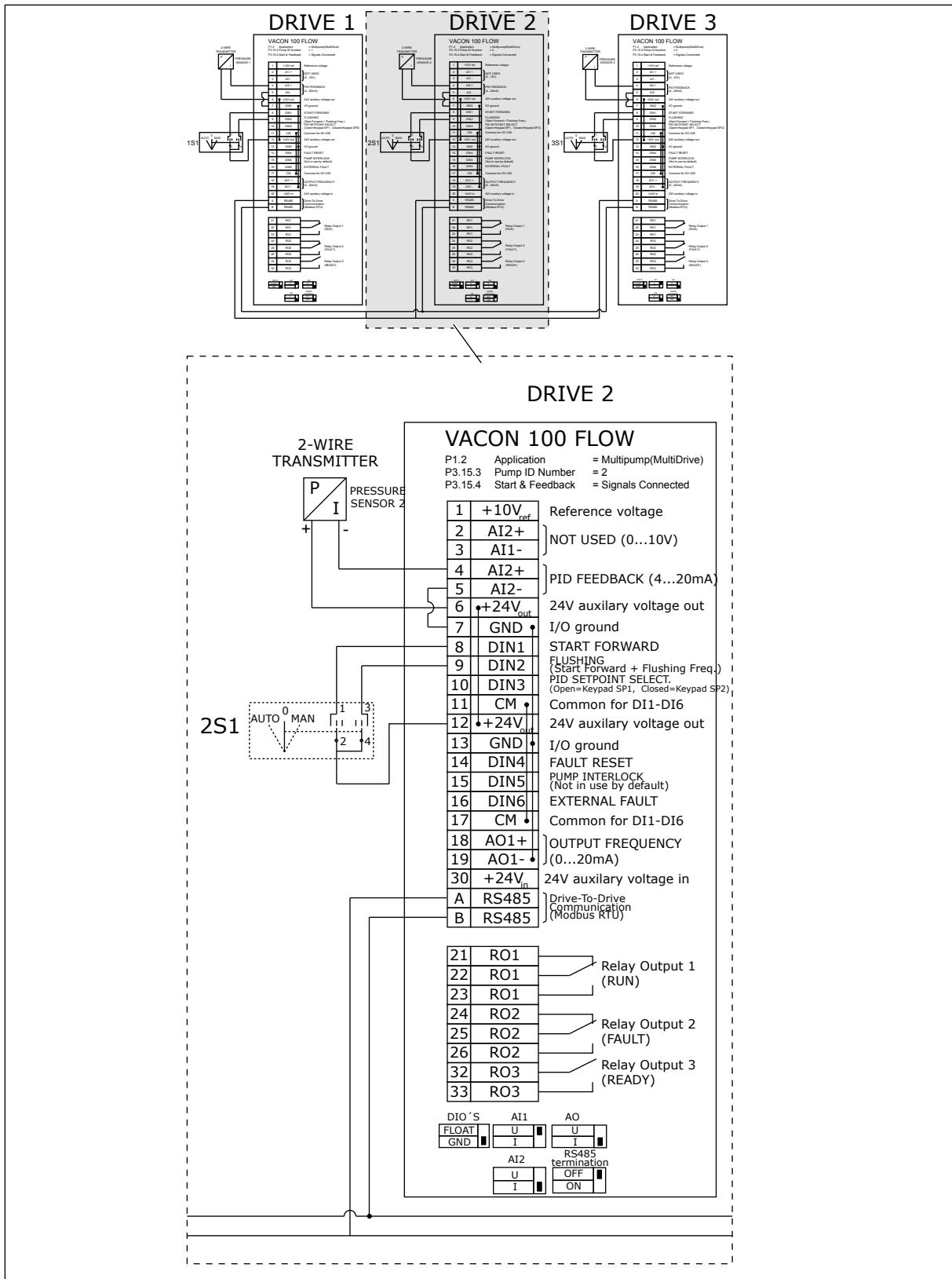

Fig. 19: Electric wiring diagramme of the Multi-pump (multidrive) system, example 1B

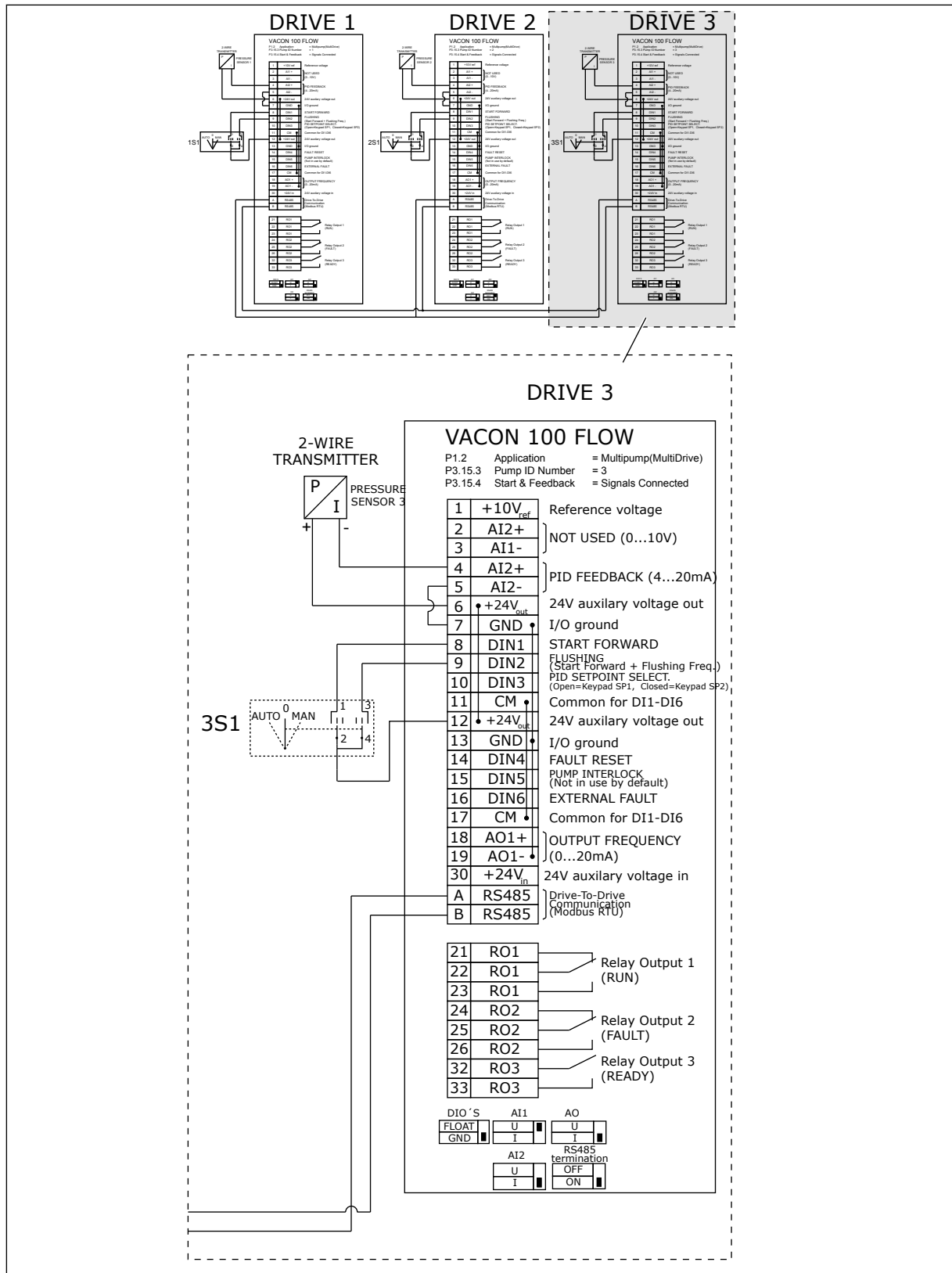

Fig. 20: Electric wiring diagramme of the Multi-pump (multidrive) system, example 1C

1 sensor is connected to all the drives. The redundancy level of the system is low because only the drives are redundant.

- If there is a drive failure, the next drive starts to operate as master.
- If there is a sensor failure, the system stops.

An individual switch that has an auto, off and man setting controls each drive. Terminal 17 connects +24V between the drive 1 and 2. External diodes are connected between terminals 1 and 2. The digital input signals use negative logic (ON = 0V).

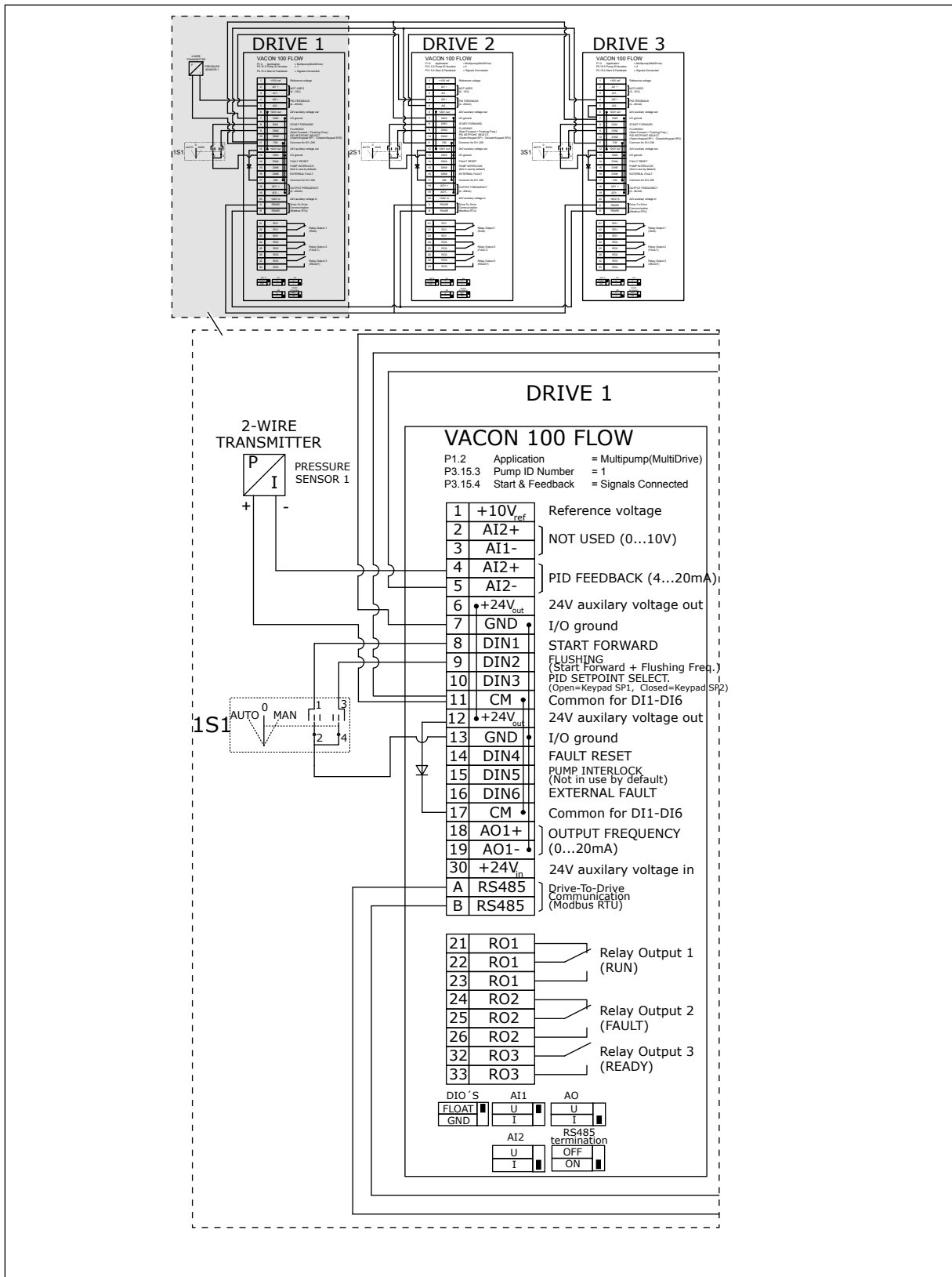

Fig. 21: Electric wiring diagramme of the Multi-pump (multidrive) system, example 2A

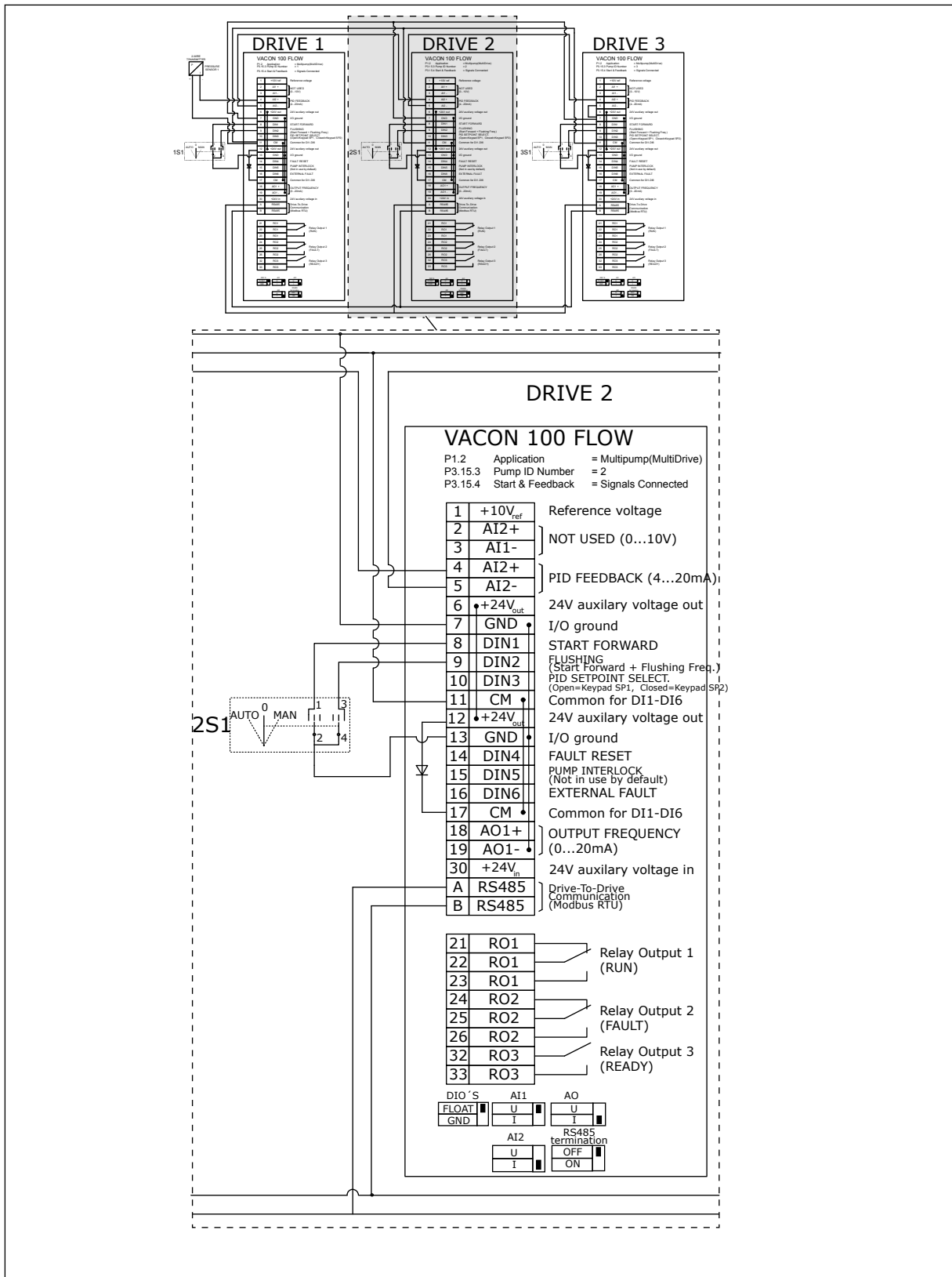

Fig. 22: Electric wiring diagramme of the Multi-pump (multidrive) system, example 2B

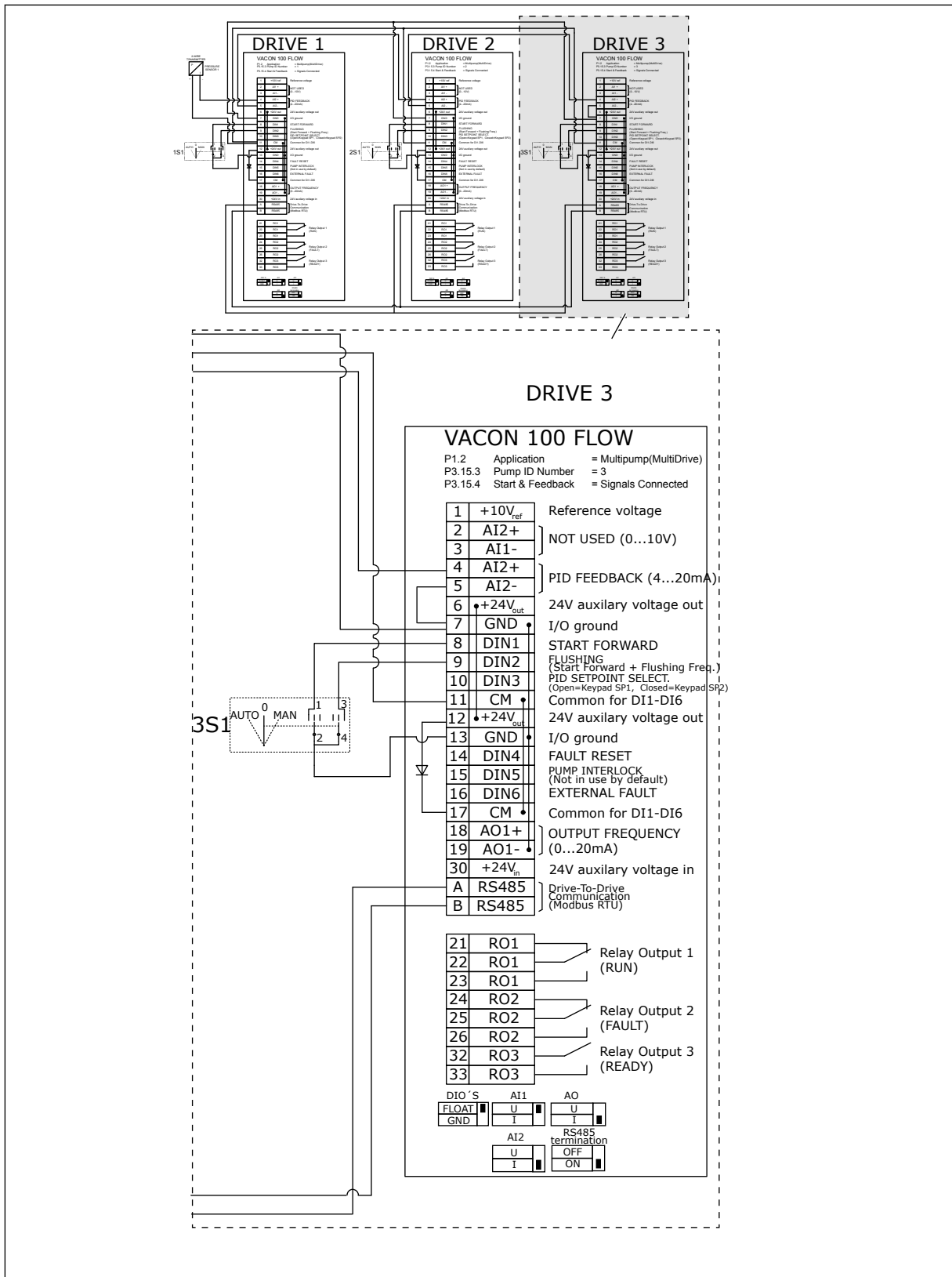

Fig. 23: Electric wiring diagramme of the Multi-pump (multidrive) system, example 2C

2 drives have individual pressure sensors. The redundancy level of the system is medium because the drives and the pressure sensors are duplicated.

- If there is a drive failure, the second drive starts to operate as master.
- If there is a sensor failure, the second drive (that has a separate sensor) starts to operate as master.

An individual switch that has an auto, off and man setting controls each drive.

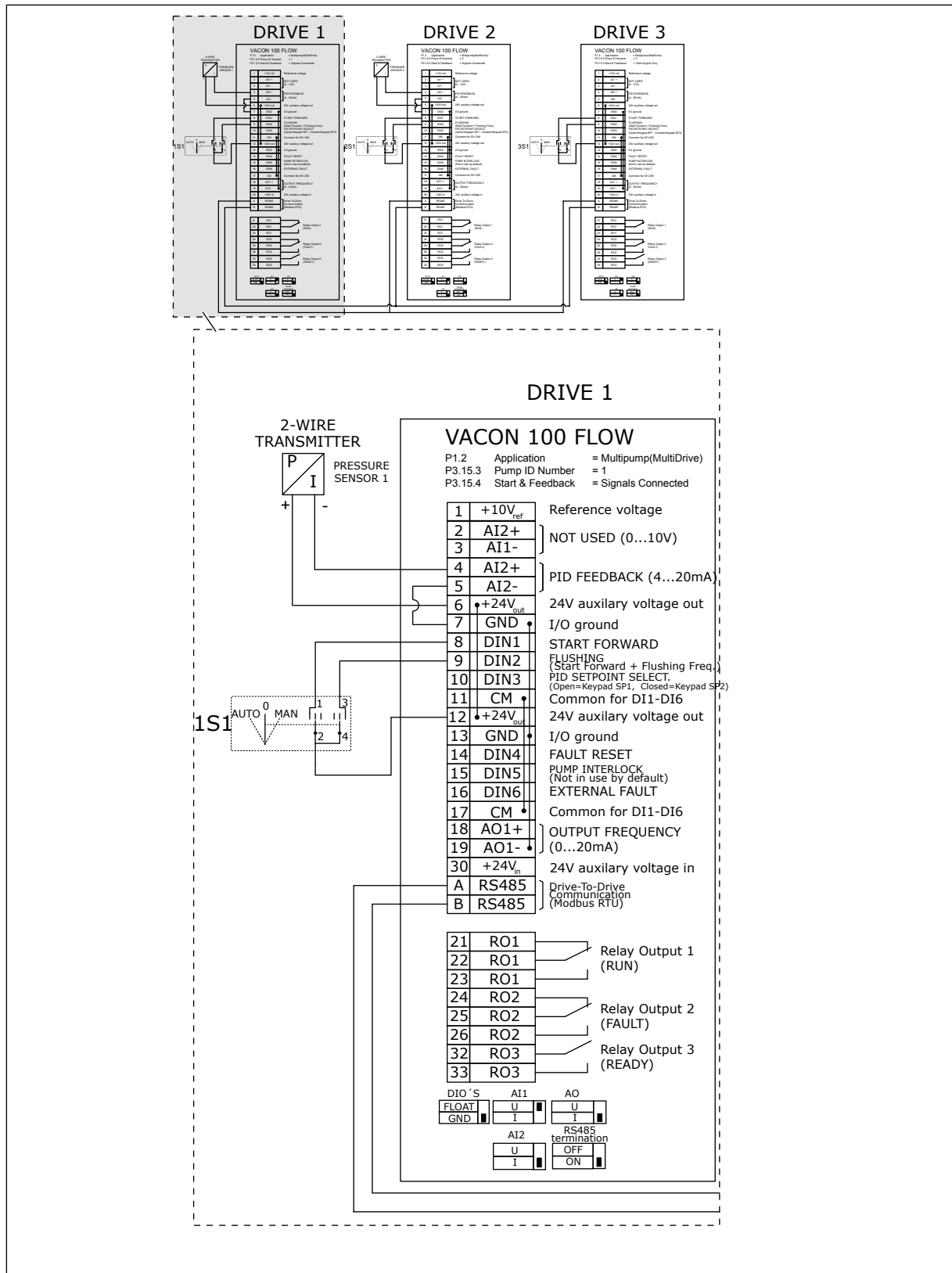

Fig. 24: Electric wiring diagramme of the Multi-pump (multidrive) system, example 3A

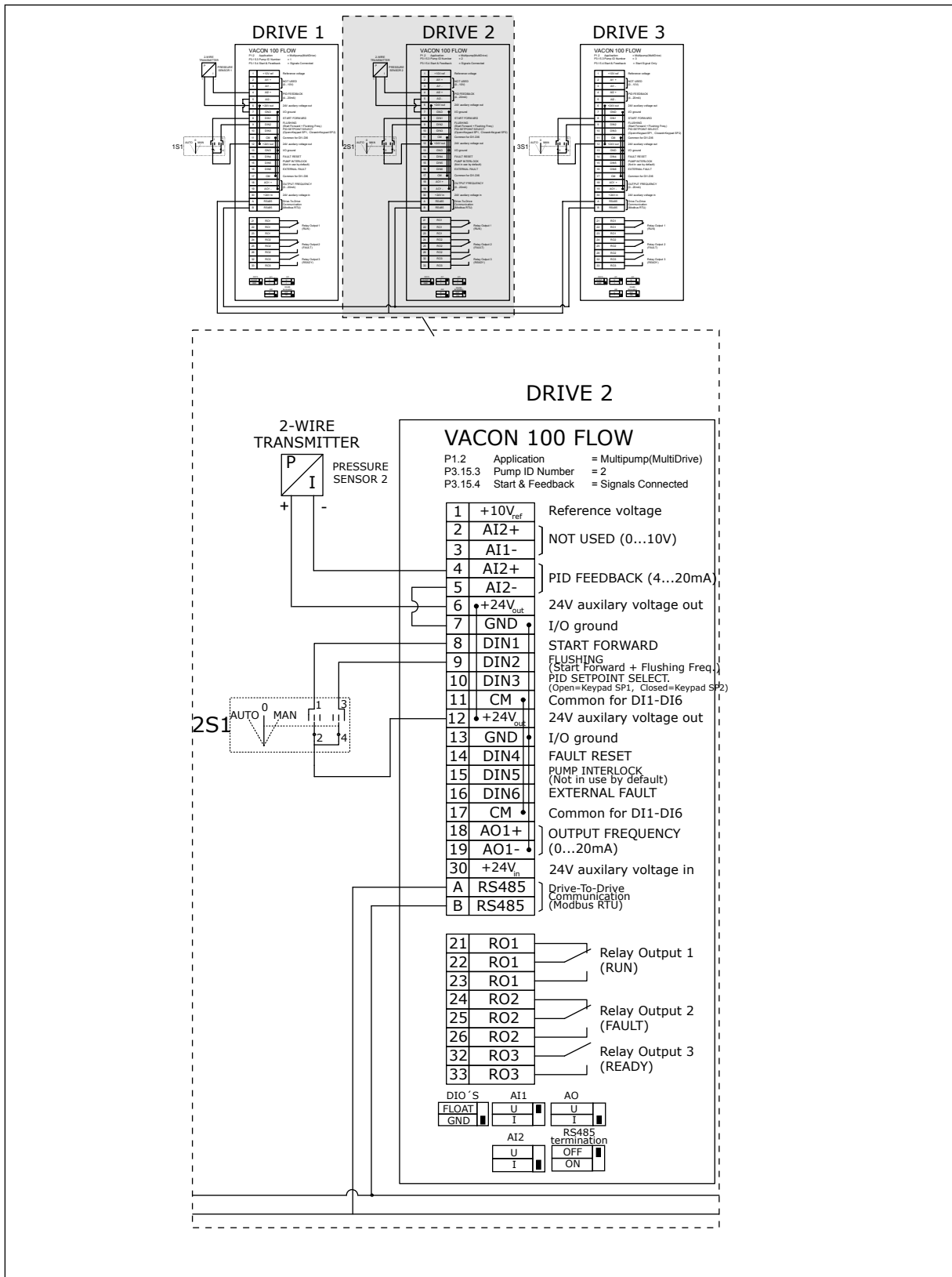

Fig. 25: Electric wiring diagramme of the Multi-pump (multidrive) system, example 3B

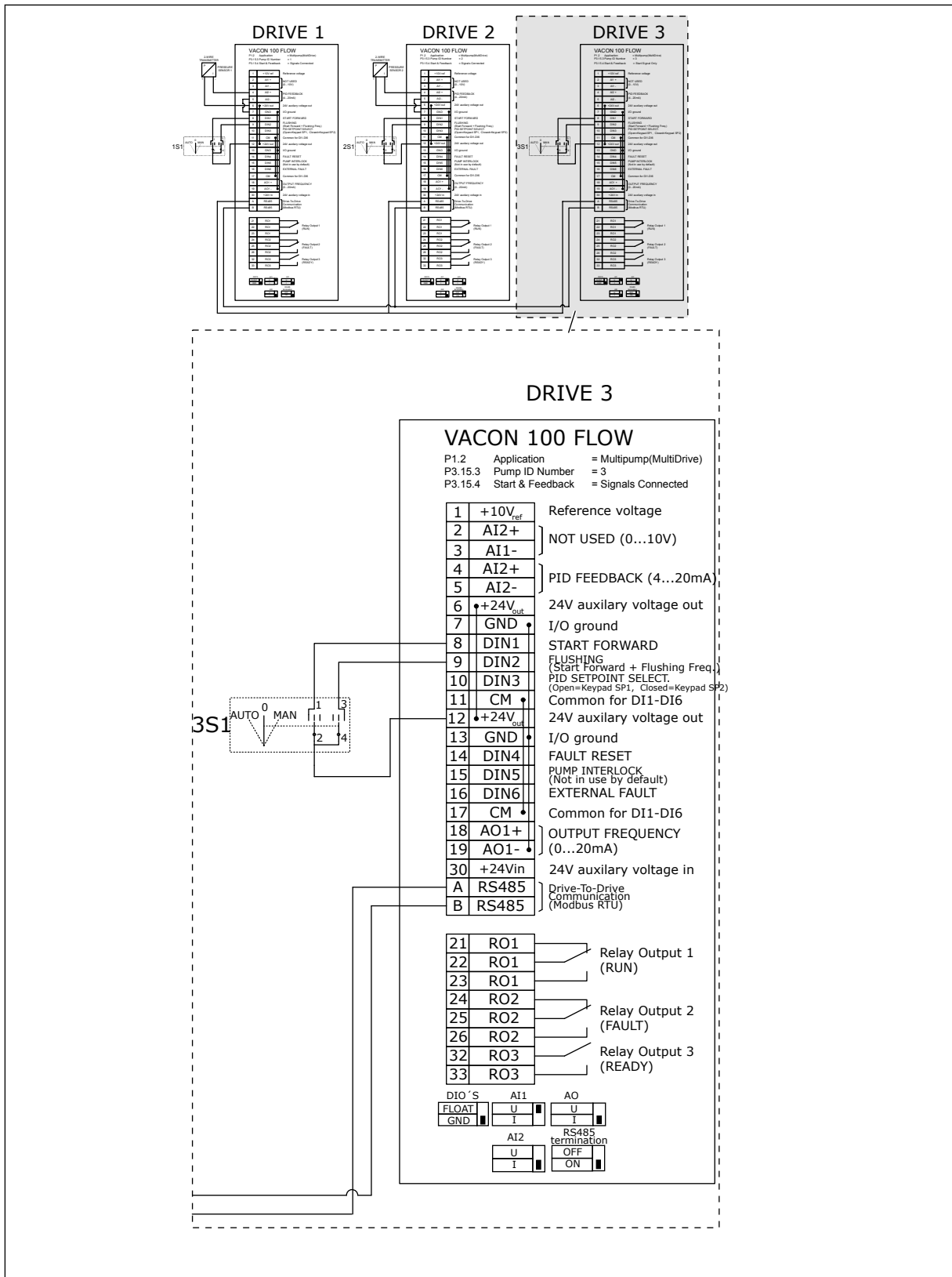

Fig. 26: Electric wiring diagramme of the Multi-pump (multidrive) system, example 3C

1 common pressure sensor is connected to 2 drives. The redundancy level of the system is low because only the drives are redundant.

- If there is a drive failure, the second drive starts to operate as master.
- If there is a sensor failure, the system stops.

An individual switch that has an auto, off and man setting controls each drive. Terminal 17 connects +24V between the drive 1 and 2. External diodes are connected between terminals 1 and 2. The digital input signals use negative logic (ON = 0V).

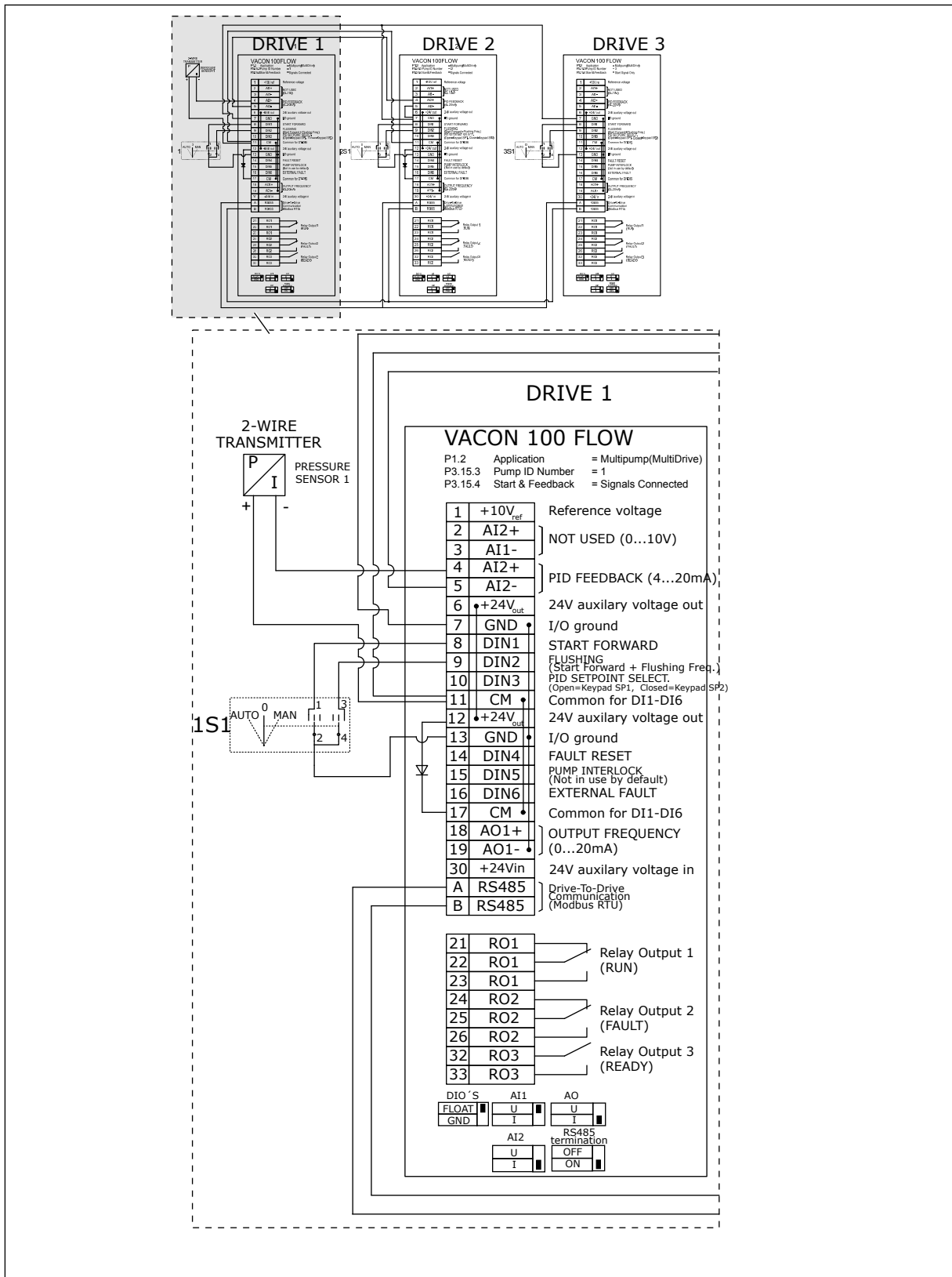

Fig. 27: Electric wiring diagramme of the Multi-pump (multidrive) system, example 4A

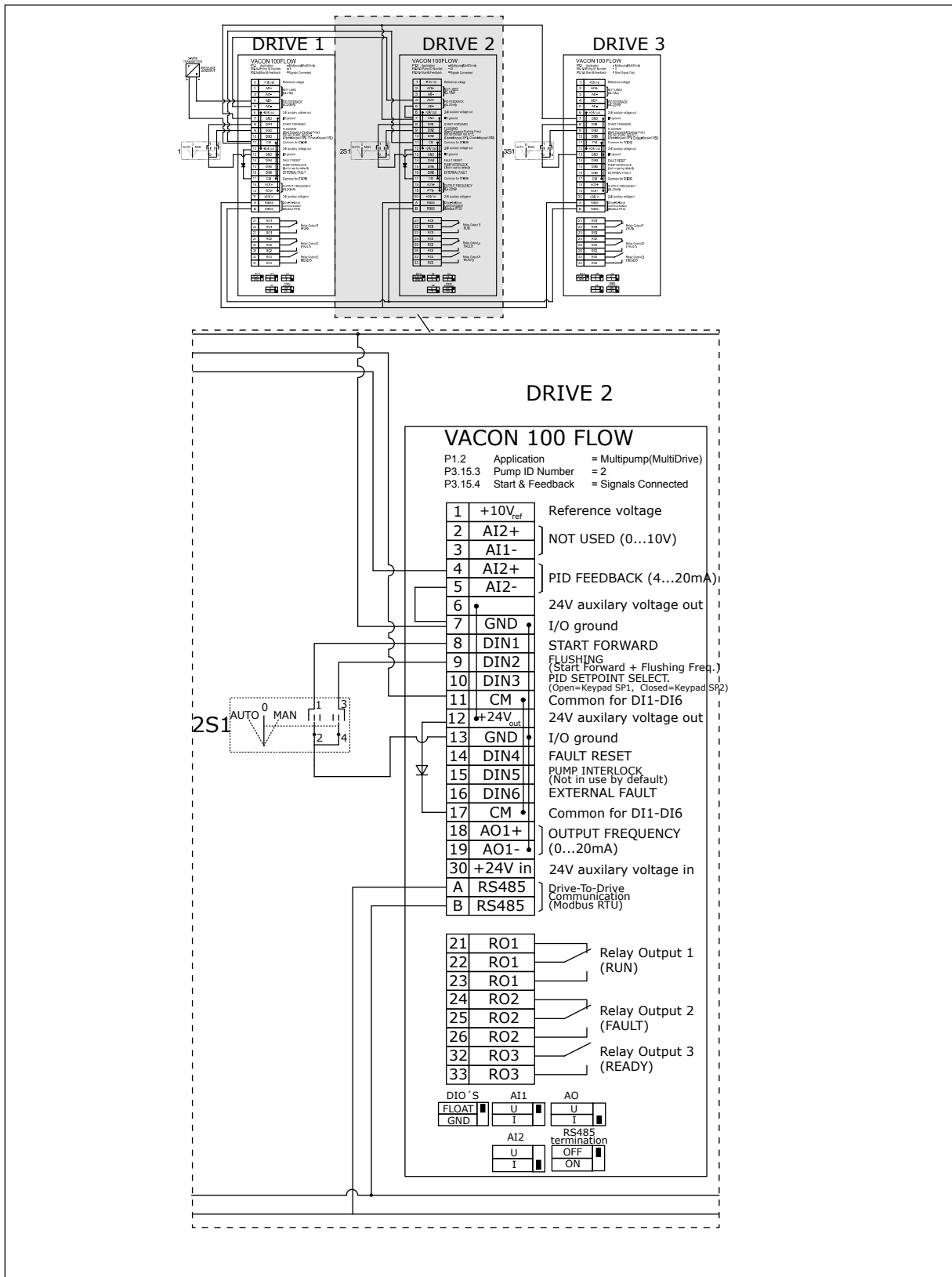

Fig. 28: Electric wiring diagramme of the Multi-pump (multidrive) system, example 4B

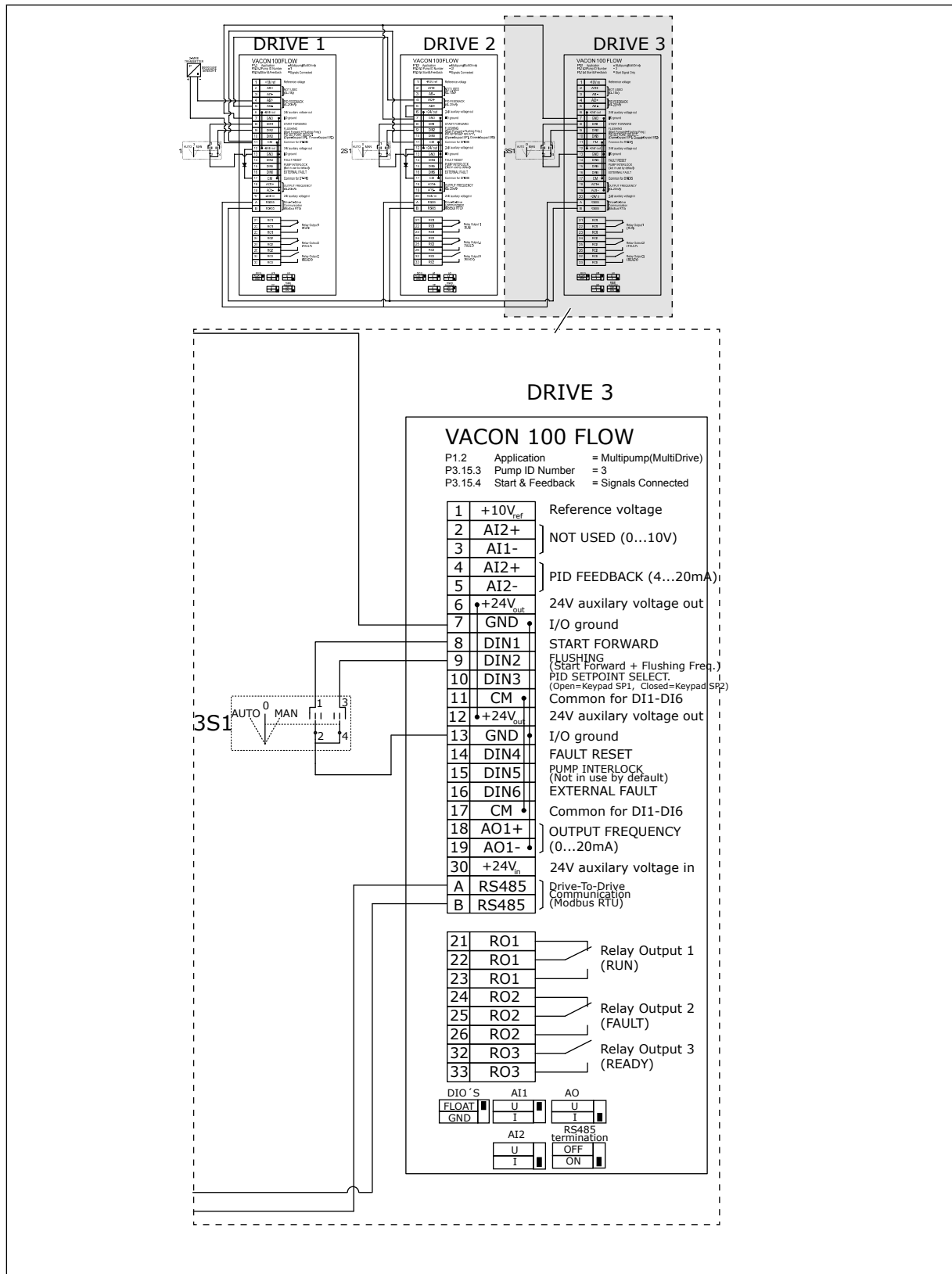

Fig. 29: Electric wiring diagramme of the Multi-pump (multidrive) system, example 4C

1 pressure sensor is connected to the first drive. The system is not redundant, because the system stops if there is a drive or sensor failure.

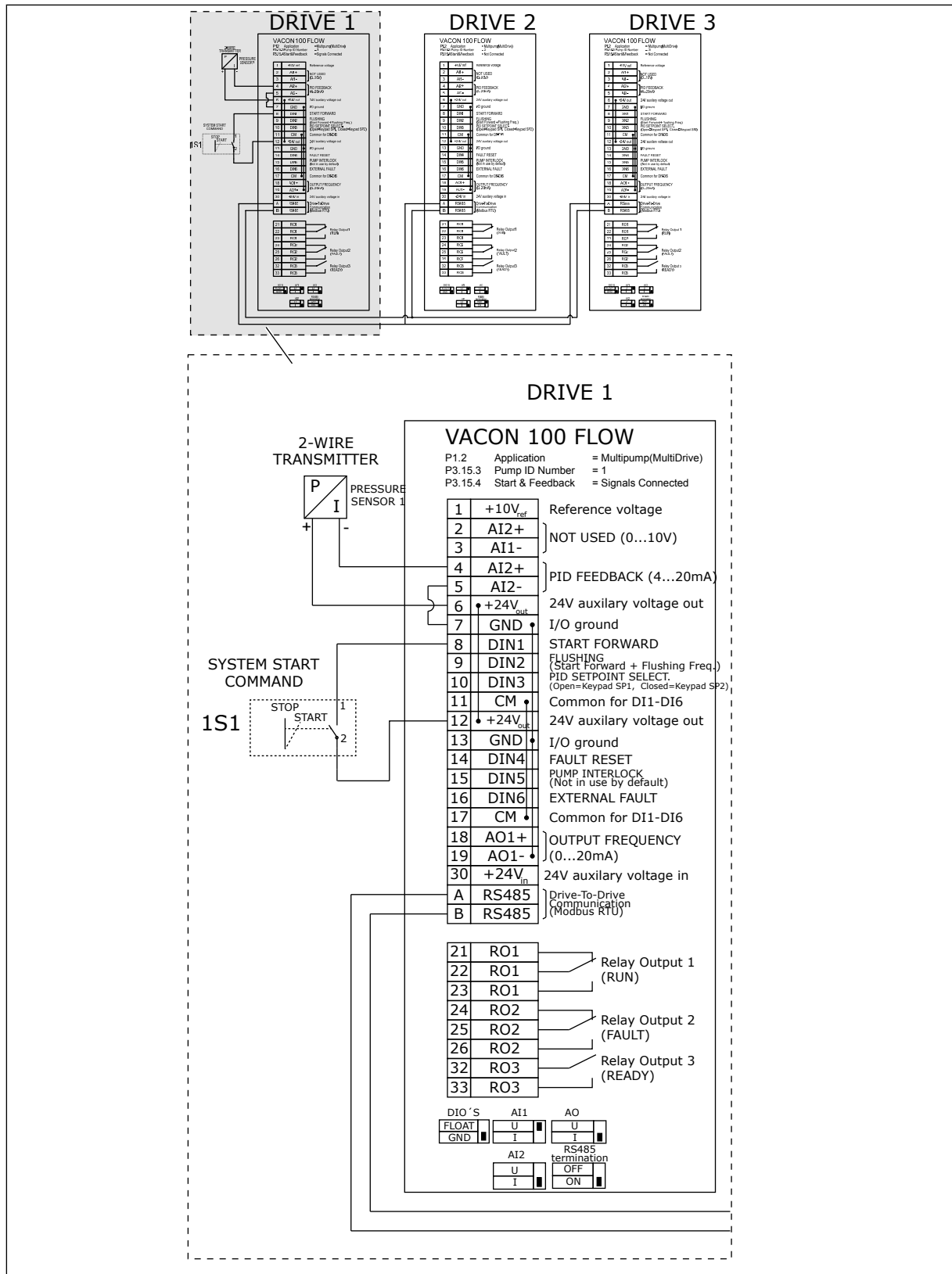

Fig. 30: Electric wiring diagramme of the Multi-pump (multidrive) system, example 5A

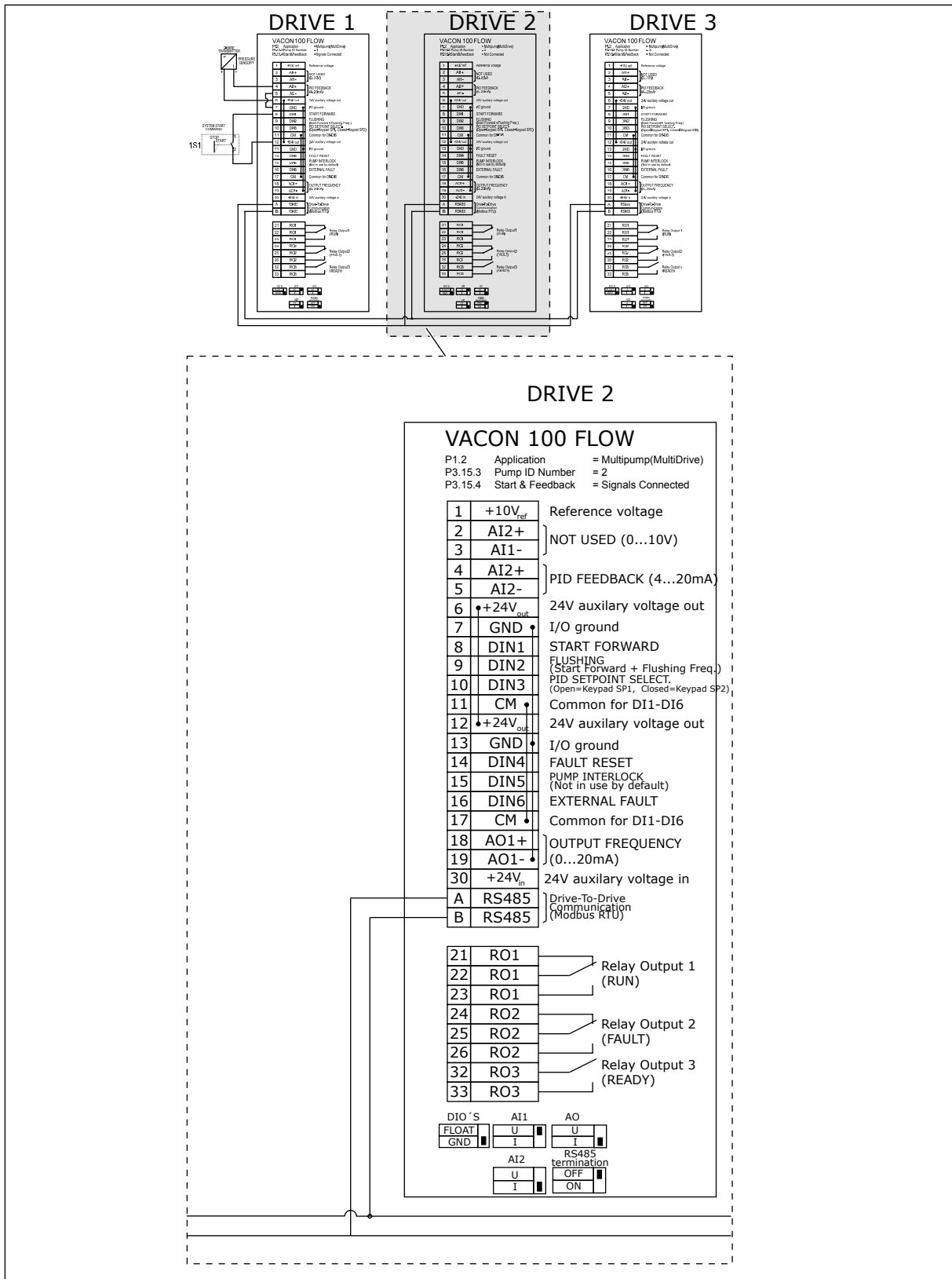

Fig. 31: Electric wiring diagramme of the Multi-pump (multidrive) system, example 5B

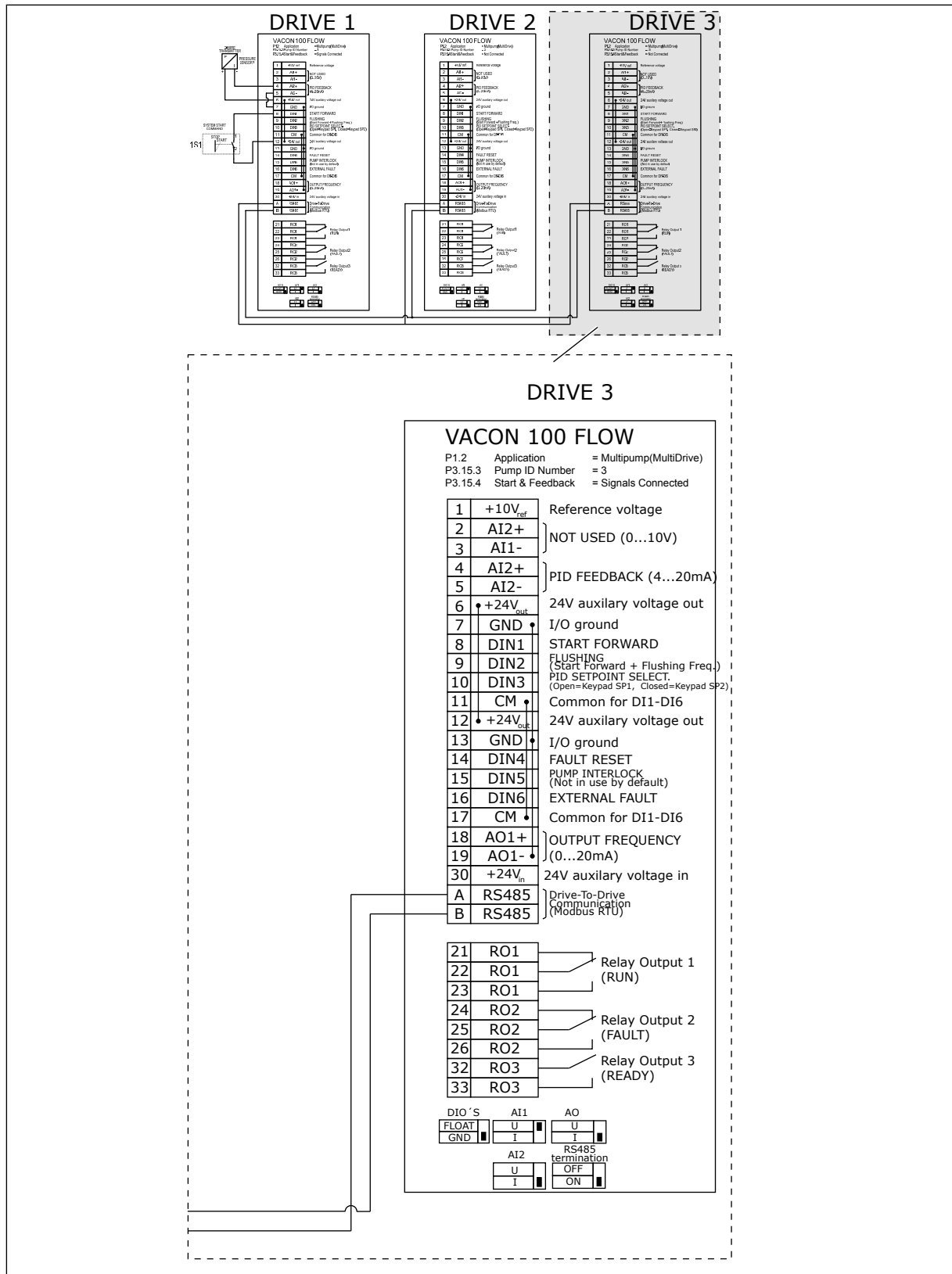

Table 11: M1.1 Wizards

Index	Parameter	Min	Max	Unit	Default	ID	Description
1.1.1	Startup Wizard	0	1		0	1170	0 = Do not activate 1 = Activate The selection Activate starts the Startup wizard (see Chapter 1.3 <i>First startup</i>).
1.1.2	Fire Mode Wizard	0	1		0	1672	The selection Activate starts the Fire mode wizard (see Chapter 1.3 <i>First startup</i>).

Table 12: M1 Quick setup

Index	Parameter	Min	Max	Unit	Default	ID	Description
1.2	Application	0	4		2	212	0 = Standard 1 = HVAC 2 = PID Control 3 = Multi-pump (single drive) 4 = Multi-pump (multidrive)
1.3	Minimum Frequency Reference	0.00	P1.4	Hz	0.0	101	The minimum frequency reference that is accepted.
1.4	Maximum Frequency Reference	P1.3	320.0	Hz	50.0 / 60.0	102	The maximum frequency reference that is accepted.
1.5	Acceleration Time 1	0.1	3000.0	s	5.0	103	Gives the quantity of time that is necessary for the output frequency to increase from 0 frequency to the maximum frequency.
1.6	Deceleration Time 1	0.1	3000.0	s	5.0	104	Gives the quantity of time that is necessary for the output frequency to decrease from the maximum frequency to 0 frequency.
1.7	Motor Current Limit	I _H *0.1	I _S	A	Varies	107	The maximum motor current from the AC drive.
1.8	Motor Type	0	2		0	650	0 = Induction Motor 1 = Permanent Magnet Motor 2 = Reluctance Motor
1.9	Motor Nominal Voltage	Varies	Varies	V	Varies	110	Find this value U _n on the nameplate of the motor. NOTE! Find out if the motor connection is Delta or Star.

Table 12: M1 Quick setup

Index	Parameter	Min	Max	Unit	Default	ID	Description
1.10	Motor Nominal Frequency	8.0	320.0	Hz	50.0 / 60.0	111	Find this value f_n on the nameplate of the motor.
1.11	Motor Nominal Speed	24	19200	Rpm	Varies	112	Find this value n_n on the nameplate of the motor.
1.12	Motor Nominal Current	$I_H * 0.1$	IS	A	Varies	113	Find this value I_n on the nameplate of the motor.
1.13	Motor Cos Phi (Power Factor)	0.30	1.00		Varies	120	Find this value on the nameplate of the motor.
1.14	Energy Optimisation	0	1		0	666	The drive finds the minimum motor current to use less energy and to lower the motor noise. Use this function with, for example, fan and pump processes. 0 = Disabled 1 = Enabled
1.15	Identification	0	2		0	631	The identification run calculates or measures the motor parameters that are necessary for a good control of the motor and speed. 0 = No action 1 = At standstill 2 = With rotation Before you do the identification run, you must set the motor nameplate parameters.
1.16	Start Function	0	1		0	505	0 = Ramping 1 = Flying Start
1.17	Stop Function	0	1		0	506	0 = Coasting 1 = Ramping

Table 12: M1 Quick setup

Index	Parameter	Min	Max	Unit	Default	ID	Description
1.18	Automatic Reset	0	1		0	731	0 = Disabled 1 = Enabled
1.19	Response to External Fault	0	3		2	701	0 = No action 1 = Alarm 2 = Fault (Stop according to stop mode) 3 = Fault (Stop by coasting)
1.20	Response to AI Low Fault	0	5		0	700	0 = No action 1 = Alarm 2 = Alarm+preset fault frequency (P3.9.1.13) 3 = Alarm + previous frequency 4 = Fault (stop according to stop mode) 5 = Fault (stop by coasting)
1.21	Remote Control Place	0	1		0	172	The selection of the remote control place (start/stop). 0 = I/O control 1 = Fieldbus control

Table 12: M1 Quick setup

Index	Parameter	Min	Max	Unit	Default	ID	Description
1.22	I/O Control Reference A Selection	1	20		6	117	<p>The selection of the frequency reference source when the control place is I/O A.</p> <p>0 = PC 1 = Preset Frequency 0 2 = Keypad Reference 3 = Fieldbus 4 = AI1 5 = AI2 6 = AI1+AI2 7 = PID Reference 8 = Motor Potentiometer 11 = Block Out.1 12 = Block Out.2 13 = Block Out.3 14 = Block Out.4 15 = Block Out.5 16 = Block Out.6 17 = Block Out.7 18 = Block Out.8 19 = Block Out.9 20 = Block Out.10</p> <p>The application that you set with parameter 1.2 gives the default value.</p>
1.23	Keypad Control Reference Selection	1	20		1	121	See P1.22.
1.24	Fieldbus Control Reference Selection	1	20		2	122	See P1.22.
1.25	AI1 Signal Range	0	1		0	379	0= 0..10V / 0..20mA 1= 2..10V / 4..20mA
1.26	AI2 Signal Range	0	1		1	390	0= 0..10V / 0..20mA 1= 2..10V / 4..20mA
1.27	RO1 Function	0	74		2	11001	See P3.5.3.2.1

Table 12: M1 Quick setup

Index	Parameter	Min	Max	Unit	Default	ID	Description
1.28	R02 Function	0	74		3	11004	See P3.5.3.2.1
1.29	R03 Function	0	74		1	11007	See P3.5.3.2.1
1.30	A01 Function	0	31		2	10050	See P3.5.4.1.1

Table 13: M1.35 Multi-pump (Multidrive)

Index	Parameter	Min	Max	Unit	Default	ID	Description
1.35.1	PID Gain	0.00	100.00	%	100.00	118	If the value of the parameter is set to 100%, a change of 10% in the error value causes the controller output to change by 10%.
1.35.2	PID Integration Time	0.00	600.00	s	1.00	119	If this parameter is set to 1,00 s, a change of 10% in the error value causes the controller output to change by 10.00%/s.
1.35.3	PID Derivation Time	0.00	100.00	s	0.00	1132	If this parameter is set to 1,00 s, a change of 10% in the error value during 1.00 s causes the controller output to change by 10.00%.
1.35.4	Process Unit Selection	1	44		1	1036	Select the unit of the process. See P3.13.1.4
1.35.5	Process Unit Min	Varies	Varies		Varies	1033	The process unit value that is the same as 0% of the PID feedback signal.
1.35.6	Process Unit Max	Varies	Varies		Varies	1034	The process unit value that is the same as 100% of the PID feedback signal.
1.35.7	Feedback 1 Source Selection	0	30		2	334	See P3.13.3.3
1.35.8	Setpoint 1 Source Selection	0	32		1	332	See P3.13.2.6
1.35.9	Keypad Setpoint 1	Varies	Varies	Varies	0	167	

Table 13: M1.35 Multi-pump (Multidrive)

Index	Parameter	Min	Max	Unit	Default	ID	Description
1.35.10	SP1 Sleep Frequency Limit	0.0	320.0	Hz	0.0	1016	The drive goes to the sleep mode when the output frequency stays below this limit for longer than is specified by parameter Sleep Delay. 0 = Not used
1.35.11	SP1 Sleep Delay	0	3000	s	0	1017	The minimum quantity of time that the frequency stays below the sleep level before the drive stops. 0 = Not used
1.35.12	SP1 Wake Up Level	Varies	Varies	Varies	Varies	1018	The wake-up value of the PID feedback supervision. Wake-up Level 1 uses the selected process units. 0 = Not used
1.35.13	Multi-pump Mode	0	2		0	1785	Selects the Multi-pump mode. 0 = Single drive 1 = Multifollower 2 = Multimaster
1.35.14	Number of Pumps	1	8		1	1001	Total number of motors (pumps/fans) used in the Multi-pump system.
1.35.15	Pump ID Number	1	8		1	1500	The order number of the drive in the pump system. This parameter is only used in multifollower or multimaster modes.

Table 13: M1.35 Multi-pump (Multidrive)

Index	Parameter	Min	Max	Unit	Default	ID	Description
1.35.16	Start and Feedback Signals	0	2		1	1782	Use this parameter to select if the start signal and/or the PIDfeedback signals are connected to the drive. 0 = Not connected 1 = Only Start Signal Connected 2 = Both Signals Connected
1.35.17	Pump Interlocking	0	1		1	1032	Enable/Disable interlocks. Interlocks tell the system if a motor is connected or not. 0 = Disabled 1 = Enabled
1.35.18	Autochange	0	2		1	1027	Disable/enable the rotation of the start order and the priority of the motors. 0 = Disabled 1 = Enabled (interval) 2 = Enabled (week-days)
1.35.19	Autochanged Pump	0	1		1	1028	0 = Auxiliary Pump 1 = All Pumps
1.35.20	Autochange Interval	0.0	3000.0	h	48.0	1029	When the time specified by the this parameter is used, the autochange function starts. But the autochange starts only if the capacity is below the level specified by parameters P1.35.23 and P1.35.24.

Table 13: M1.35 Multi-pump (Multidrive)

Index	Parameter	Min	Max	Unit	Default	ID	Description
1.35.21	Autochange Days	0	127			1786	Range: Monday to Sunday
1.35.22	Autochange Time of Day			Time		1787	Range: 00:00:00 to 23:59:59
1.35.23	Autochange: Frequency Limit	0.00	P3.3.1.2	Hz	25:00	1031	These parameters set the level below which the capacity must stay for the autochange to start.
1.35.24	Autochange: Pump Limit	1	6			1030	
1.35.25	Bandwidth	0	100	%	10	1097	When the feedback value stays between 4.5 and . 5.5 bar, the motor stays connected. Setpoint = 5 bar Bandwidth = 10% When the feedback value stays between 4.5 and 5.5 bar, the motor stays connected.
1.35.26	Bandwidth Delay	0	3600	s	10	1098	When the feedback is outside the bandwidth, the time after which pumps are added or removed.
1.35.27	Constant Production Speed	0	100	%	100	1513	Gives the constant speed at which the pump locks, when the pump goes to the maximum frequency. The next pump starts the regulation in the multimaster mode.
1.35.28	Pump 1 Interlock				DigIN Slot0.1	426	OPEN = Not active CLOSED = Active
1.35.29	Flushing Reference	Maximum reference	Maximum reference	HZ	50.00	1239	Gives the frequency reference when the flush function is activated.

2 WIZARDS

2.1 STANDARD APPLICATION WIZARD

The application wizard helps you to set the basic parameters that are related to the application.

To start the Standard application wizard, set the value *Standard* to parameter P1.2 Application (ID 212) in the keypad.



NOTE!

If you start the Standard application wizard from the Startup wizard, the wizard goes directly to step 11.

1	Set a value for P3.1.2.2 Motor Type (so that it agrees with the nameplate of the motor)	PM motor Induction motor Reluctance motor
2	Set a value for P3.1.1.1 Motor Nominal Voltage (so that it agrees with the nameplate of the motor)	Range: Varies
3	Set a value for P3.1.1.2 Motor Nominal Frequency (so that it agrees with the nameplate of the motor)	Range: 8.00-320.00 Hz
4	Set a value for P3.1.1.3 Motor Nominal Speed (so that it agrees with the nameplate of the motor)	Range: 24-19200 rpm
5	Set a value for P3.1.1.4 Motor Nominal Current (so that it agrees with the nameplate of the motor)	Range: Varies

Step 6 shows only, if you selected *Induction Motor* in step 1.

6	Set a value for P3.1.1.5 Motor Cos Phi	Range: 0.30-1.00
7	Set a value for P3.3.1.1 Minimum Frequency Reference	Range: 0.00-P3.3.1.2 Hz
8	Set value for P3.3.1.2 Maximum Frequency Reference	Range: P3.3.1.1-320.00 Hz
9	Set a value for P3.4.1.2 Acceleration Time 1	Range: 0.1-3000.0 s
10	Set value for P3.4.1.3 Deceleration Time 1	Range: 0.1-3000.0 s
11	Select the control place that gives the drive the start or stop commands and the frequency reference.	I/O Terminal Fieldbus Keypad

The Standard application wizard is completed.

2.2 HVAC APPLICATION WIZARD

The application wizard helps you to set the basic parameters that are related to the application.

To start the HVAC application wizard, set the value *HVAC* to parameter P1.2 Application (ID 212) in the keypad.

1	Select the type or process (or application) that you control.	Compressor Fan Pump Other
----------	---	------------------------------------

Some parameters have preset values specified by the selection you made in step 1. See the parameters and their values at the end of this chapter in *Table 14*.

2	Set a value for P3.2.11 Restart Delay.	Range: 0-20 min
----------	--	-----------------

Step 2 shows only if you selected *Compressor* in step 1.

3	Set a value for P3.1.2.2 Motor Type (so that it agrees with the nameplate of the motor)	PM motor Induction motor Reluctance motor
4	Set a value for P3.1.1.1 Motor Nominal Voltage (so that it agrees with the nameplate of the motor)	Range: Varies
5	Set a value for P3.1.1.2 Motor Nominal Frequency (so that it agrees with the nameplate of the motor)	Range: 8.00-320.00 Hz
6	Set a value for P3.1.1.3 Motor Nominal Speed (so that it agrees with the nameplate of the motor)	Range: 24-19200 rpm
7	Set a value for P3.1.1.4 Motor Nominal Current (so that it agrees with the nameplate of the motor)	Range: Varies
8	Set a value for P3.1.1.5 Motor Cos Phi (so that it agrees with the nameplate of the motor)	Range: 0.30-1.00

Step 8 shows only if you selected *Induction Motor* in step 3.

9	Set a value for P3.3.1.1 Minimum Frequency Reference	Range: 0.00-3.3.1.2 Hz
10	Set a value for P3.3.1.2 Maximum Frequency Reference	Range: P3.3.1.1-320.00 Hz

Steps 11 and 12 show only if you selected *Other* in step 1.

11	Set a value for P3.4.1.2 Acceleration Time 1	Range: 0.1-3000.0 s
12	Set a value for P3.4.1.3 Deceleration Time 1	Range: 0.1-3000.0 s

Next the wizard goes to steps that are specified by the application.

13	Select the control place (where you give the start and stop commands and the frequency reference)	I/O Terminal Fieldbus Keypad
----	---	------------------------------------

The HVAC application wizard is completed.

Table 14: Preset values of parameters

Index	Parameter	Process type		
		Pump	Fan	Compressor
P3.1.4.1	U/f Ratio	Linear	Squared	Linear
P3.2.4	Start Function	Ramping	Flying start	Ramping
P3.2.5	Stop Function	Ramping	Coasting	Ramping
P3.4.1.2	Acceleration Time	5.0 s	30.0 s	3.0 s
P3.4.1.3	Deceleration Time	5.0 s	30.0 s	3.0 s

2.3 PID CONTROL APPLICATION WIZARD

The application wizard helps you to set the basic parameters that are related to the application.

To start the PID control application wizard, set the value *PID control* to parameter P1.2 Application (ID 212) in the keypad.



NOTE!

If you start the application wizard from the Startup wizard, the wizard goes directly to step 11.

1	Set a value for P3.1.2.2 Motor Type (so that it agrees with the nameplate of the motor)	PM motor Induction motor Reluctance motor
2	Set a value for P3.1.1.1 Motor Nominal Voltage (so that it agrees with the nameplate of the motor)	Range: Varies
3	Set a value for P3.1.1.2 Motor Nominal Frequency (so that it agrees with the nameplate of the motor)	Range: 8.00...320.00 Hz
4	Set a value for P3.1.1.3 Motor Nominal Speed (so that it agrees with the nameplate of the motor)	Range: 24...19200 rpm
5	Set a value for P3.1.1.4 Motor Nominal Current (so that it agrees with the nameplate of the motor)	Range: Varies

Step 6 shows only, if you selected *Induction Motor* in step 1.

6	Set a value for P3.1.1.5 Motor Cos Phi	Range: 0.30-1.00
7	Set a value for P3.3.1.1 Minimum Frequency Reference	Range: 0.00-P3.3.1.2 Hz
8	Set value for P3.3.1.2 Maximum Frequency Reference	Range: P3.3.1.1-320.00 Hz
9	Set a value for P3.4.1.2 Acceleration Time 1	Range: 0.1-3000.0 s
10	Set value for P3.4.1.3 Deceleration Time 1	Range: 0.1-3000.0 s
11	Make a selection of a control place (where you give the start and stop commands and the frequency reference)	I/O Terminal Fieldbus Keypad
12	Set a value for P3.13.1.4 Process Unit Selection	More than 1 selection

If your selection is other than %, you see the next questions. If your selection is %, the wizard goes directly to step 16.

13	Set a value for P3.13.1.5 Process Unit Min	The range is specified by the selection in step 12.
14	Set a value for P3.13.1.6 Process Unit Max	The range is specified by the selection in step 12.
15	Set a value for P3.13.1.7 Process Unit Decimals	Range: 0-4
16	Set a value for P3.13.3.3 Feedback 1 Source Selection	See the table Feedback settings in <i>Table 76 Feedback settings</i>

If you make a selection of an analogue input signal, you see step 18. With other selections, the wizard goes to step 19.

17	Set the signal range of the analogue input	0 = 0-10V / 0-20mA 1 = 2-10V / 4-20mA
18	Set a value for P3.13.1.8 Error Inversion	0 = Normal 1 = Inverted
19	Set a value for P3.13.2.6 Setpoint Source Selection	See table Setpoints in <i>Table 76 Feedback settings</i>

If you select an analogue input signal, step 21 shows. With other selections, the wizard goes to step 23.

If you set *Keypad Setpoint 1* or *Keypad Setpoint 2* as the value, the wizard goes directly to step 22.

20	Set the signal range of the analogue input	0 = 0-10V / 0-20mA 1 = 2-10V / 4-20mA
21	Set a value for P3.13.2.1 (Keypad Setpoint 1) and P3.13.2.2 (Keypad Setpoint 2)	Specified by the range set in step 20
22	Use the sleep function	0 = No 1 = Yes

If you give the value *Yes* for the question 22, you see the next 3 questions. If you give the value *No*, the wizard is completed.

23	Set a value for P3.13.5.1 SP1 Sleep Frequency Limit	Range: 0.00-320.00 Hz
24	Set a value for P3.13.5.2 SP1 Sleep Delay	Range: 0-3000 s
25	Set a value for P3.13.5.3 SP1 Wake Up Level	The range is specified by the set process unit.

The PID control application wizard is completed.

2.4 MULTI-PUMP (SINGLE DRIVE) APPLICATION WIZARD

The application wizard helps you to set the basic parameters that are related to the application.

To start the Multi-pump (single drive) application wizard, set the value *Multi-pump (Single drive)* to parameter P1.2 Application (ID 212) in the keypad.



NOTE!

If you start the application wizard from the Startup wizard, the wizard goes directly to step 11.

1	Set a value for P3.1.2.2 Motor Type (so that it agrees with the nameplate of the motor)	PM motor Induction motor Reluctance motor
2	Set a value for P3.1.1.1 Motor Nominal Voltage (so that it agrees with the nameplate of the motor)	Range: Varies
3	Set a value for P3.1.1.2 Motor Nominal Frequency (so that it agrees with the nameplate of the motor)	Range: 8.00-320.00 Hz
4	Set a value for P3.1.1.3 Motor Nominal Speed (so that it agrees with the nameplate of the motor)	Range: 24-19200 rpm
5	Set a value for P3.1.1.4 Motor Nominal Current (so that it agrees with the nameplate of the motor)	Range: Varies

Step 6 shows only, if you selected *Induction Motor* in step 1.

6	Set a value for P3.1.1.5 Motor Cos Phi	Range: 0.30-1.00
7	Set a value for P3.3.1.1 Minimum Frequency Reference	Range: 0.00-P3.3.1.2 Hz
8	Set value for P3.3.1.2 Maximum Frequency Reference	Range: P3.3.1.1-320.00 Hz
9	Set a value for P3.4.1.2 Acceleration Time 1	Range: 0.1-3000.0 s
10	Set value for P3.4.1.3 Deceleration Time 1	Range: 0.1-3000.0 s
11	Make a selection of a control place (where you give the start and stop commands and the frequency reference)	I/O Terminal Fieldbus Keypad
12	Set a value for P3.13.1.4 Process Unit Selection	More than 1 selection

If your selection is other than %, you see the next 3 steps. If your selection is %, the wizard goes directly to step 16.

13	Set a value for P3.13.1.5 Process Unit Min	The range is specified by the selection in step 12.
14	Set a value for P3.13.1.6 Process Unit Max	The range is specified by the selection in step 12.
15	Set a value for P3.13.1.7 Process Unit Decimals	Range: 0-4
16	Set a value for P3.13.3.3 Feedback 1 Source Selection	See the table Feedback settings in <i>Table 76 Feedback settings</i>

If you make a selection of an analogue input signal, you see step 17. With other selections, the wizard goes to step 18.

17	Set the signal range of the analogue input	0 = 0-10V / 0-20mA 1 = 2-10V / 4-20mA
18	Set a value for P3.13.1.8 Error Inversion	0 = Normal 1 = Inverted
19	Set a value for P3.13.2.6 Setpoint Source Selection	See table Setpoints in <i>Table 75 Setpoint settings</i>

If you select an analogue input signal, step 20 shows first, and then step 22 shows. With other selections, the wizard goes to step 21.

If you set *Keypad Setpoint 1* or *Keypad Setpoint 2* as the value, the wizard goes directly to step 22.

20	Set the signal range of the analogue input	0 = 0-10V / 0-20mA 1 = 2-10V / 4-20mA
21	Set a value for P3.13.2.1 (Keypad Setpoint 1) and P3.13.2.2 (Keypad Setpoint 2)	Specified by the range set in step 19
22	Use the sleep function	0 = No 1 = Yes

If you give the value *Yes* in step 22, you see the next 3 steps. If you give the value *No*, the wizard goes to step 26.

23	Set a value for P3.13.5.1 SP1 Sleep Frequency Limit	Range: 0.00-320.00 Hz
24	Set a value for P3.13.5.2 SP1 Sleep Delay	Range: 0-3000 s
25	Set a value for P3.13.5.3 SP1 Wake Up Level	The range is specified by the set process unit.
26	Set a value for P3.15.2 Number of pumps	Range: 1-8
27	Set a value for P3.15.5 Pump Interlocking	0 = Not used 1 = Enabled
28	Set a value for P3.15.6 Autochange	0 = Disabled 1 = Enabled (Interval) 2 = Enabled (Weekdays)

If you set the value *Enabled* (Interval or Weekdays) to parameter Autochange, steps 29-34 show. If you set the value *Disabled* to parameter Autochange, the wizard goes directly to step 35.

29	Set a value for P3.15.7 Autochanged pumps	0 = Auxiliary pumps 1 = All pumps
-----------	---	--------------------------------------

Step 30 shows only if you set the value *Enabled (Interval)* to parameter Autochange in step 28.

30	Set a value for P3.15.8 Autochange Interval	Range: 0-3000 h
-----------	---	-----------------

Steps 31 and 32 show only if you set the value *Enabled (Weekdays)* to parameter Autochange in step 28.

31	Set a value for P3.15.9 Autochange Days	Range: Monday to Sunday
32	Set a value for P3.15.10 Autochange Time of Day	Range: 00:00:00 to 23:59:59
33	Set a value for P3.15.11 Autochange Frequency Limit	Range: P3.3.1.1-P3.3.1.2 Hz
34	Set a value for P3.15.12 Autochange Pump Limit	Range: 1-8
35	Set a value for P3.15.13 Bandwidth	Range: 0-100%
36	Set a value for P3.15.14 Bandwidth Delay	Range: 0-3600 s

The Multi-pump (single drive) application wizard is completed.

2.5 MULTI-PUMP (MULTIDRIVE) APPLICATION WIZARD

The application wizard helps you to set the basic parameters that are related to the application.

To start the Multi-pump (multidrive) application wizard, set the value *Multi-pump (Multidrive)* to parameter P1.2 Application (ID 212) in the keypad.



NOTE!

If you start the application wizard from the Startup wizard, the wizard goes directly to step 11.

1	Set a value for P3.1.2.2 Motor Type (so that it agrees with the nameplate of the motor)	PM motor Induction motor Reluctance motor
2	Set a value for P3.1.1.1 Motor Nominal Voltage (so that it agrees with the nameplate of the motor)	Range: Varies
3	Set a value for P3.1.1.2 Motor Nominal Frequency (so that it agrees with the nameplate of the motor)	Range: 8.00-320.00 Hz
4	Set a value for P3.1.1.3 Motor Nominal Speed (so that it agrees with the nameplate of the motor)	Range: 24-19200 rpm
5	Set a value for P3.1.1.4 Motor Nominal Current (so that it agrees with the nameplate of the motor)	Range: Varies

Step 6 shows only, if you selected *Induction Motor* in step 1.

6	Set a value for P3.1.1.5 Motor Cos Phi	Range: 0.30-1.00
7	Set a value for P3.3.1.1 Minimum Frequency Reference	Range: 0.00-P3.3.1.2 Hz
8	Set value for P3.3.1.2 Maximum Frequency Reference	Range: P3.3.1.1-320.00 Hz
9	Set a value for P3.4.1.2 Acceleration Time 1	Range: 0.1-3000.0 s
10	Set value for P3.4.1.3 Deceleration Time 1	Range: 0.1-3000.0 s
11	Make a selection of a control place (where you give the start and stop commands and the frequency reference)	I/O Terminal Fieldbus Keypad
12	Set a value for P3.13.1.4 Process Unit Selection	More than 1 selection

If your selection is other than %, you see the next 3 steps. If your selection is %, the wizard goes directly to step 16.

13	Set a value for P3.13.1.5 Process Unit Min	The range is specified by the selection in step 12.
14	Set a value for P3.13.1.6 Process Unit Max	The range is specified by the selection in step 12.
15	Set a value for P3.13.1.7 Process Unit Decimals	Range: 0-4
16	Set a value for P3.13.3.3 Feedback 1 Source Selection	See the table Feedback settings in Chapter <i>Table 75 Setpoint settings</i>

If you make a selection of an analogue input signal, you see step 17. With other selections, the wizard goes to step 18.

17	Set the signal range of the analogue input	0 = 0-10V / 0-20mA 1 = 2-10V / 4-20mA
18	Set a value for P3.13.1.8 Error Inversion	0 = Normal 1 = Inverted
19	Set a value for P3.13.2.6 Setpoint Source Selection	See table Setpoints in Chapter <i>Table 75 Setpoint settings</i>

If you select an analogue input signal, step 20 shows first, and then step 22 shows. With other selections, the wizard goes to step 21.

If you set *Keypad Setpoint 1* or *Keypad Setpoint 2* as the value, the wizard goes directly to step 22.

20	Set the signal range of the analogue input	0 = 0-10V / 0-20mA 1 = 2-10V / 4-20mA
21	Set a value for P3.13.2.1 (Keypad Setpoint 1) and P3.13.2.2 (Keypad Setpoint 2)	Specified by the range set in step 19
22	Use the sleep function	0 = No 1 = Yes

If you give the value *Yes* in step 22, you see the next 3 steps. If you give the value *No*, the wizard goes to step 26.

23	Set a value for P3.13.5.1 SP1 Sleep Frequency Limit	Range: 0.00-320.00 Hz
24	Set a value for P3.13.5.2 SP1 Sleep Delay	Range: 0-3000 s
25	Set a value for P3.13.5.3 SP1 Wake Up Level	The range is specified by the set process unit.
26	Set a value for P3.15.1 Multi-pump Mode	Multifollower Multimaster
27	Set a value for P3.15.3 Pump ID Number	Range: 1-8
28	Set a value for P3.15.4 Start and Feedback	0 = Not connected 1 = Only Start Signal Connected 2 = Both Signals Connected
29	Set a value for P3.15.2 Number of pumps	Range: 1-8
30	Set a value for P3.15.5 Pump Interlocking	0 = Not used 1 = Enabled
31	Set a value for P3.15.6 Autochange	0 = Disabled 1 = Enabled (Interval) 2 = Enabled (Weekdays)

If you set the value *Enabled (Interval)* to parameter Autochange, step 33 shows. If you set the value *Enabled (Weekdays)* to parameter Autochange, step 34 shows. If you set the value *Disabled* to parameter Autochange, the wizard goes directly to step 36.

32	Set a value for P3.15.7 Autochanged pumps	0 = Auxiliary pumps 1 = All pumps
-----------	---	--------------------------------------

Step 33 shows only if you set the value *Enabled (Interval)* to parameter Autochange in step 31.

33	Set a value for P3.15.8 Autochange Interval	Range: 0-3000 h
-----------	---	-----------------

Steps 34 and 35 show only if you set the value *Enabled (Weekdays)* to parameter Autochange in step 31.

34	Set a value for P3.15.9 Autochange Days	Range: Monday to Sunday
35	Set a value for P3.15.10 Autochange Time of Day	Range: 00:00:00 to 23:59:59
36	Set a value for P3.15.13 Bandwidth	Range: 0-100%
37	Set a value for P3.15.14 Bandwidth Delay	Range: 0-3600 s

The Multi-pump (multidrive) application wizard is completed.

2.6 FIRE MODE WIZARD

To start the Fire mode wizard, make the selection *Activate* for parameter 1.1.2 in the Quick setup menu.



CAUTION!

Before you continue, read about the password and warranty in Chapter 10.18 *Fire mode*.

1	Set a value for parameter P3.17.2 Fire Mode Frequency Source	More than 1 selection
----------	--	-----------------------

If you set a value other than *Fire mode frequency*, the wizard goes directly to step 3.

2	Set a value for parameter P3.17.3 Fire Mode Frequency	Range: varies
3	Activate the signal when the contact opens or when it closes	0 = Open contact 1 = Closed contact

If you set the value *Open contact* in step 3, the wizard goes directly to step 5. If you set the value *Closed contact* in step 3, step 5 is unnecessary.

4	Set a value for parameters P3.17.4 Fire Mode Activation on OPEN / P3.17.5 Fire Mode Activation on CLOSE	Make a selection of a digital input to activate Fire mode. See also Chapter 10.6.1 <i>Programming of digital and analogue inputs</i> .
5	Set a value for parameter P3.17.6 Fire Mode Reverse	Make a selection of a digital input to activate the reverse direction in Fire mode. DigIn Slot0.1 = FORWARD DigIn Slot0.2 = REVERSE
6	Set a value for P3.17.1 Fire Mode Password	Set a password to enable the Fire mode function. 1234 = Enable test mode 1002 = Enable Fire mode

The Fire mode wizard is completed.

3 USER INTERFACES

3.1 NAVIGATION ON THE KEYPAD

The data of the AC drive is in menus and submenus. To move between the menus, use the arrow buttons Up and Down in the keypad. To go into a group or an item, push the OK button. To go back to the level where you were before, push the Back/Reset button.

On the display, you see your current location in the menu, for example M3.2.1. You also see the name of the group or item in your current location.

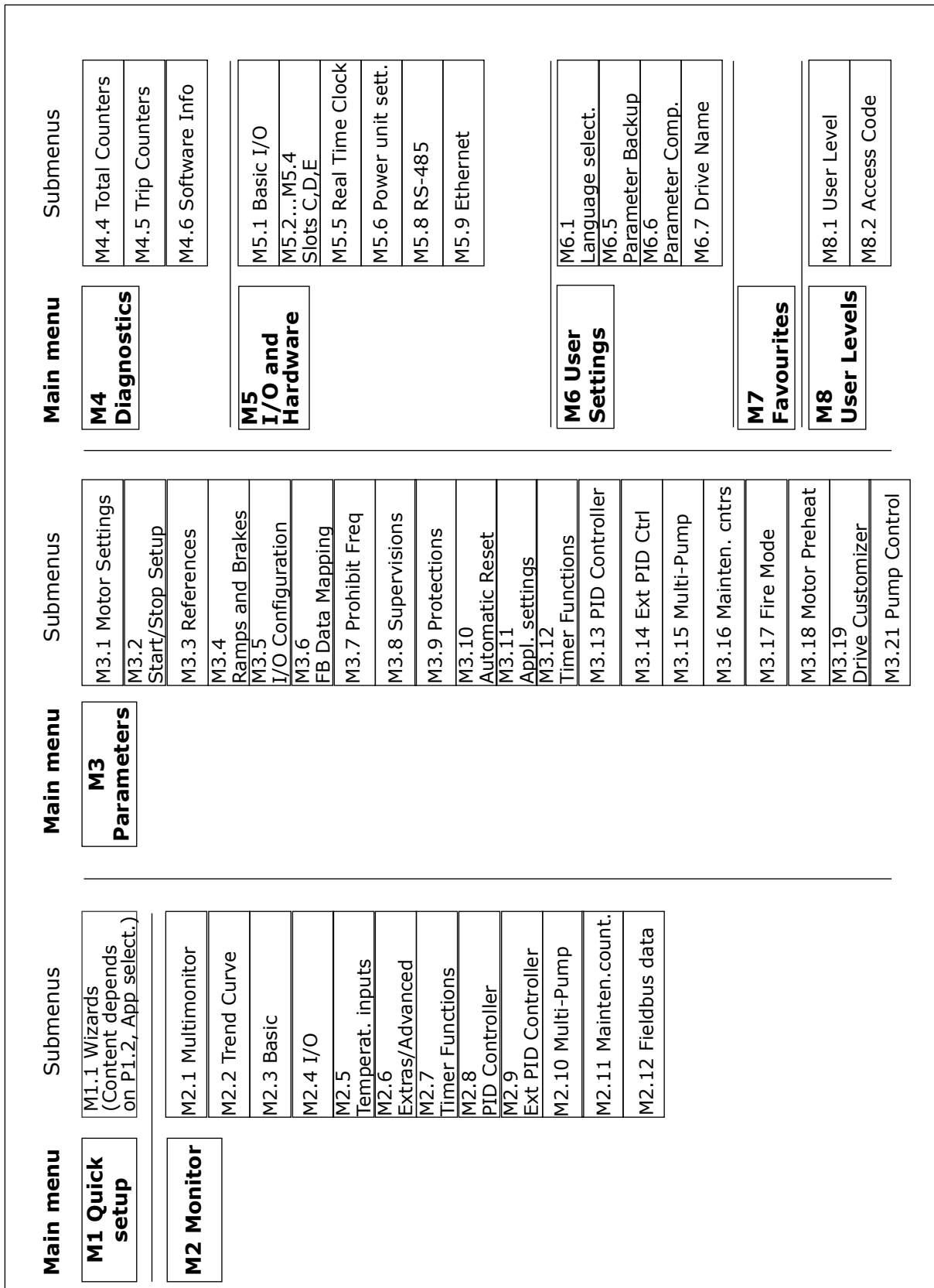

Fig. 32: The basic menu structure of the AC drive

3.2 USING THE GRAPHICAL DISPLAY

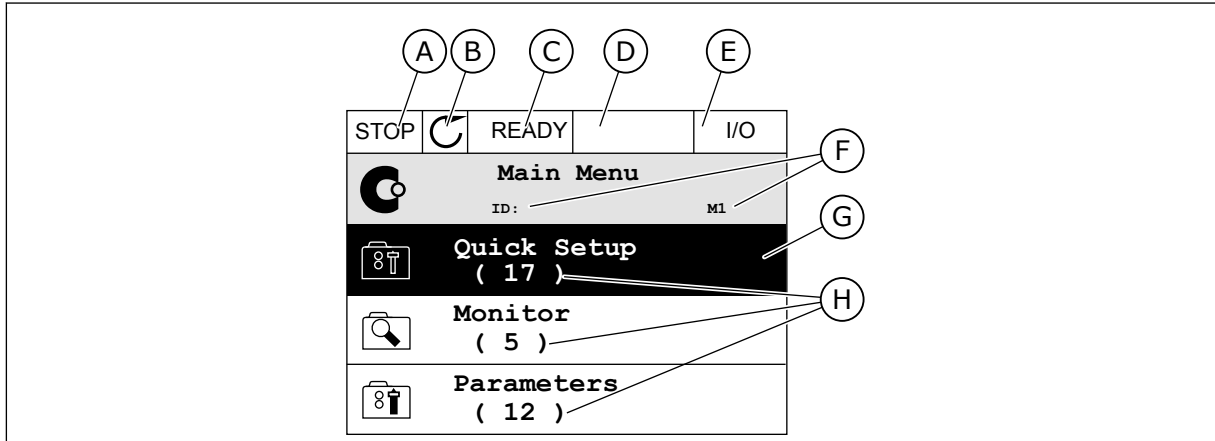

Fig. 33: The main menu of the graphical display

- A. The first status field: STOP/RUN
- B. The rotation direction
- C. The second status field: READY/NOT READY/FAULT
- D. The alarm field: ALARM/-
- E. The control place: PC/I/O/KEYPAD/ FIELDBUS
- F. The location field: the parameter ID number and the current location in the menu
- G. An activated group or item: push OK to go in
- H. The number of items in the group in question

3.2.1 EDITING THE VALUES

On the graphical display, there are 2 different procedures to edit the value of an item.

Usually, you can set only 1 value for a parameter. Select from a list of text values or from a range of numerical values.

CHANGING THE TEXT VALUE OF A PARAMETER

- 1 Find the parameter with the arrow buttons.

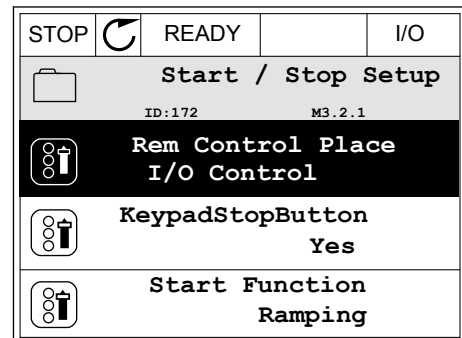

- To go to the Edit mode, push the OK button 2 times or push the arrow button Right.

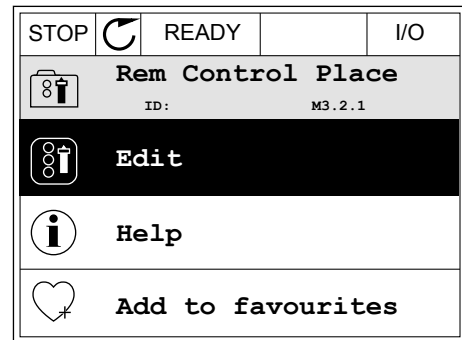

- To set a new value, push the arrow buttons Up and Down.

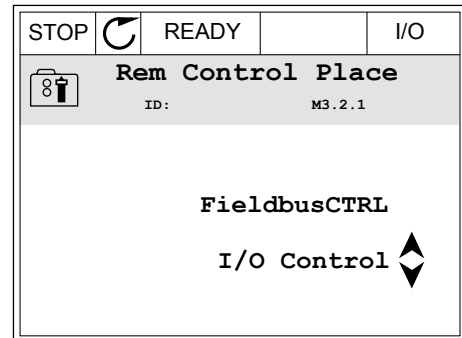

- To accept the change, push the OK button. To ignore the change, use the Back/Reset button.

EDITING THE NUMERICAL VALUES

- Find the parameter with the arrow buttons.

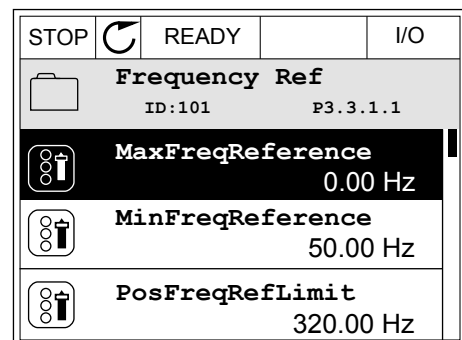

- Go to the Edit mode.

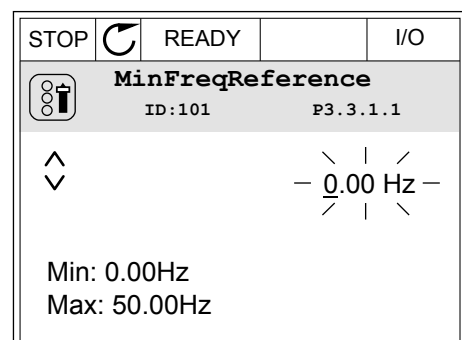

- 3 If the value is numerical, move from digit to digit with the arrow buttons Left and Right. Change the digits with the arrow buttons Up and Down.

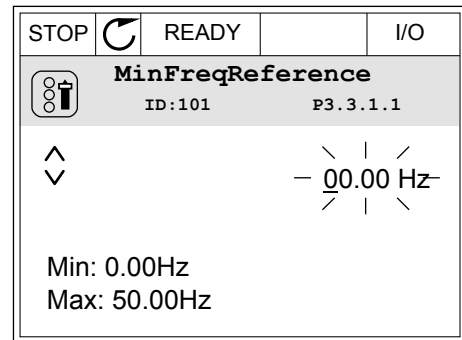

- 4 To accept the change, push the OK button. To ignore the change, go back to the level where you were before with the Back/Reset button.

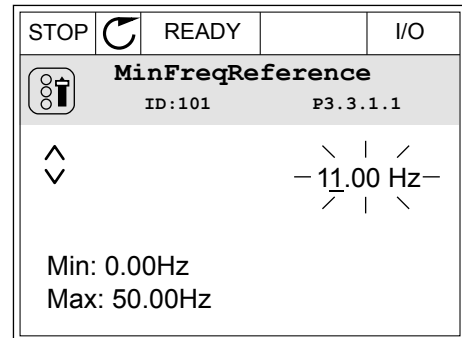

THE SELECTION OF MORE THAN 1 VALUE

Some parameters let you to make a selection of more than 1 value. Select a checkbox at each necessary value.

- 1 Find the parameter. There is a symbol on the display when a checkbox selection is possible.

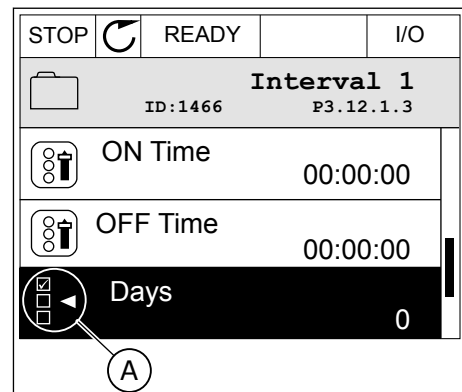

- A. The symbol of the checkbox selection

- To move in the list of values, use the arrow buttons Up and Down.

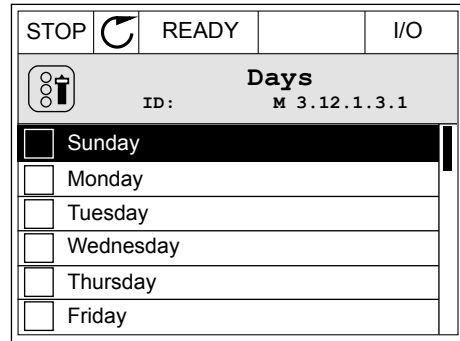

- To add a value into your selection, select the box that is next to it with the arrow button Right.

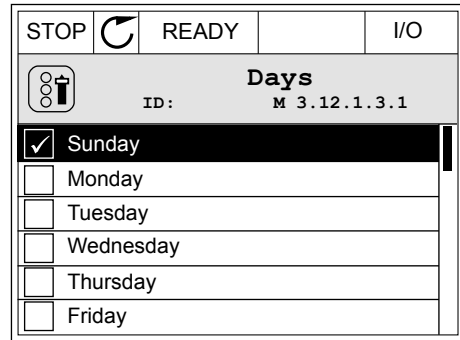

3.2.2 RESETTING A FAULT

To reset a fault, you can use the Reset button or the parameter Reset Faults. See the instructions in *11.1 A fault comes into view*.

3.2.3 THE FUNCT BUTTON

You can use the FUNCT button for 4 functions.

- To have an access to the Control page.
- To easily change between the Local and Remote control places.
- To change the rotation direction.
- To quickly edit a parameter value.

The selection of the control place determines from where the AC drive takes the start and stop commands. All the control places have a parameter for the selection of the frequency reference source. The Local control place is always the keypad. The Remote control place is I/O or Fieldbus. You can see the current control place on the status bar of the display.

It is possible to use I/O A, I/O B and Fieldbus as Remote control places. I/O A and Fieldbus have the lowest priority. You can make a selection of them with P3.2.1 (Remote Control Place). I/O B can bypass the Remote control places I/O A and Fieldbus with a digital input. You can make a selection of the digital input with parameter P3.5.1.7 (I/O B Control Force).

The keypad is always used as a control place when the control place is Local. Local control has higher priority than Remote control. For example, when you are in Remote control, if parameter P3.5.1.7 bypasses the control place with a digital input, and you make a selection of Local, Keypad becomes the control place. Use the FUNCT button or P3.2.2 Local/Remote to change between the Local and Remote control.

CHANGING THE CONTROL PLACE

1 Anywhere in the menu structure, push the FUNCT button.

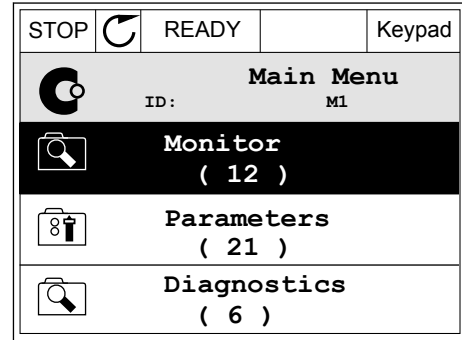

2 To make a selection of the Local/Remote, use the arrow buttons Up and Down. Push the OK button.

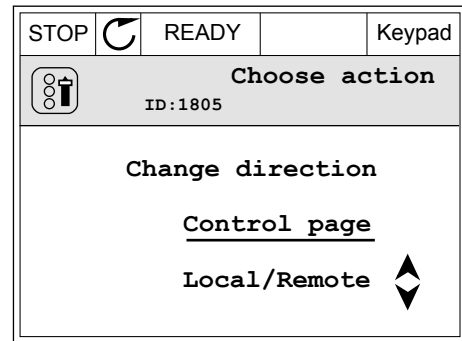

3 To make a selection of Local or Remote, use the arrow buttons Up and Down again. To accept the selection, push the OK button.

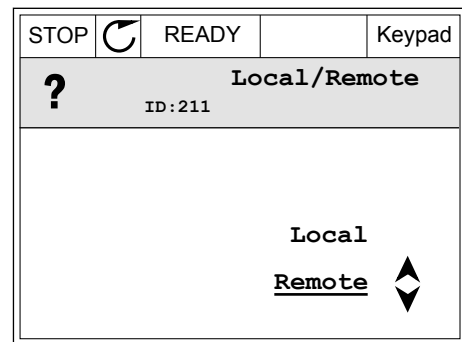

4 If you changed Remote control place to Local, that is, the keypad, give a keypad reference.

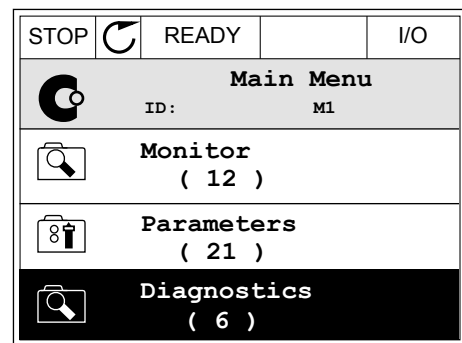

After the selection, the display goes back into the same location where it was when you pushed the FUNCT button.

GOING INTO THE CONTROL PAGE

It is easy to monitor the most important values in the Control page.

- 1 Anywhere in the menu structure, push the FUNCT button.

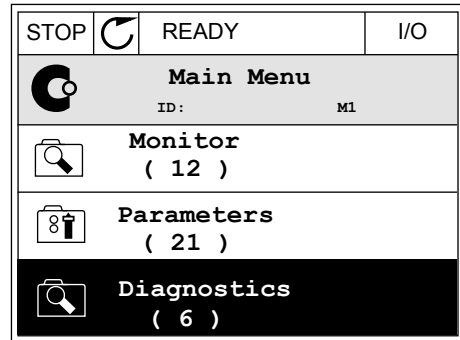

- 2 To make a selection of the Control page, push the arrow buttons Up and Down. Go in with the OK button. The control page opens.

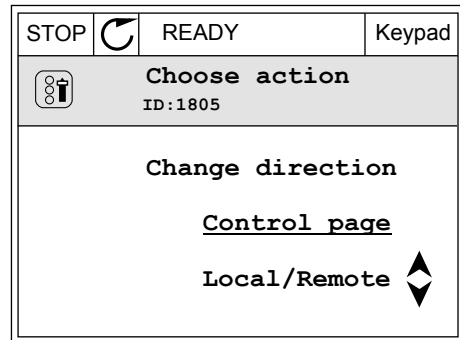

- 3 If you use the Local control place and the keypad reference, you can set P3.3.1.8 Keypad Reference with the OK button.

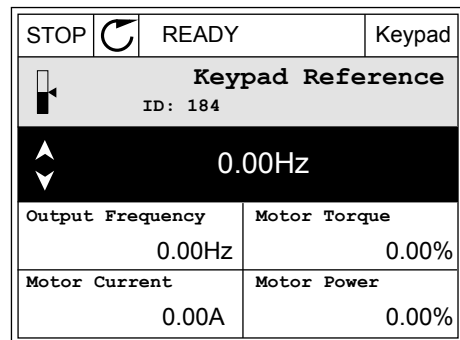

- 4 To change the digits in the value, push the arrow buttons Up and Down. Accept the change with the OK button.

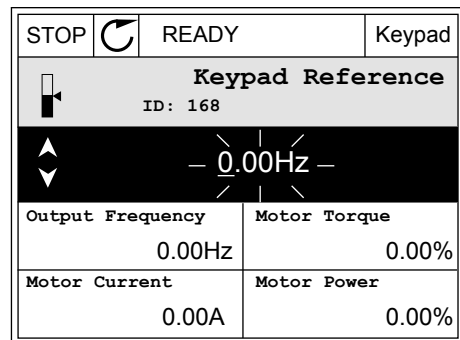

See more information about Keypad Reference in *5.3 Group 3.3: References*. If you use other control places or reference values, the display shows the frequency reference, which you

cannot edit. The other values on the page are Multimonitoring values. You can make a selection of the values that show up here (see instructions in 4.1.1 Multimonitor).

CHANGING THE ROTATION DIRECTION

You can change the rotation direction of the motor quickly with the FUNCT button.



NOTE!

The command Change direction is available in the menu only if the current control place is Local.

- 1 Anywhere in the menu structure, push the FUNCT button.

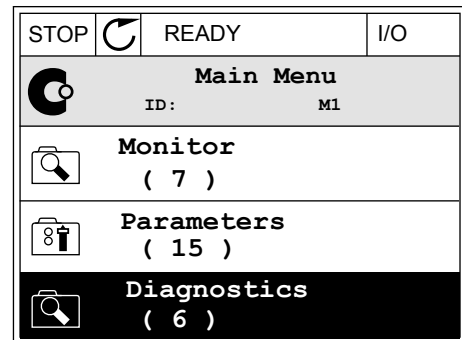

- 2 To make a selection of the Change direction, push the arrow buttons Up and Down. Push the OK button.

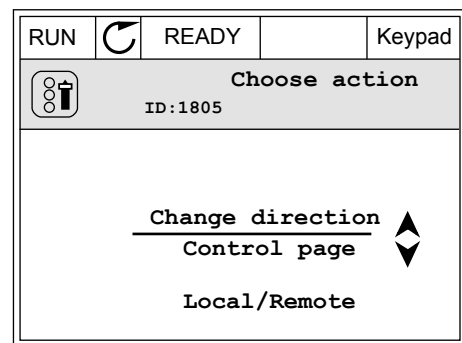

- 3 Make a selection of a new rotation direction. The current rotation direction blinks. Push the OK button.

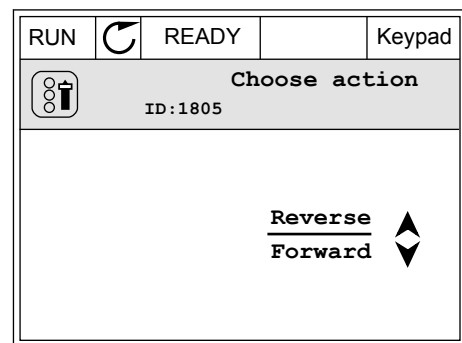

- 4 The rotation direction changes immediately. You can see that the arrow indication in the status field of the display changes.

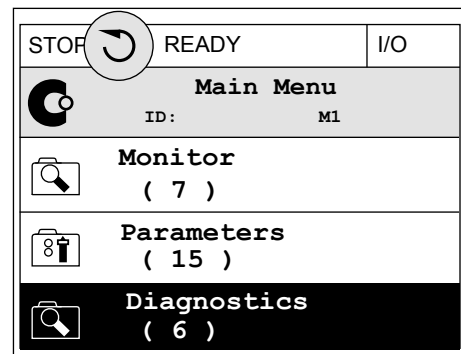

THE QUICK EDIT FUNCTION

With the Quick edit function, you can have a quick access to a parameter by typing the ID number of the parameter.

- 1 Anywhere in the menu structure, push the FUNCT button.
- 2 Push the arrow buttons Up and Down to make a selection of Quick Edit and accept with the OK button.
- 3 Write the ID number of a parameter or monitoring value. Push OK. The display shows the parameter value in the edit mode and the monitoring value in the monitoring mode.

3.2.4 COPYING THE PARAMETERS



NOTE!

This function is available only in the graphical display.

Before you can copy parameters from the control panel to the drive, you must stop the drive.

COPYING THE PARAMETERS OF AN AC DRIVE

Use this function to copy parameters from a drive to another.

- 1 Save the parameters to the control panel.
- 2 Detach the control panel and connect it to another drive.
- 3 Download the parameters to the new drive with the command Restore from keypad.

SAVING THE PARAMETERS TO THE CONTROL PANEL

1 Go into the User settings menu.

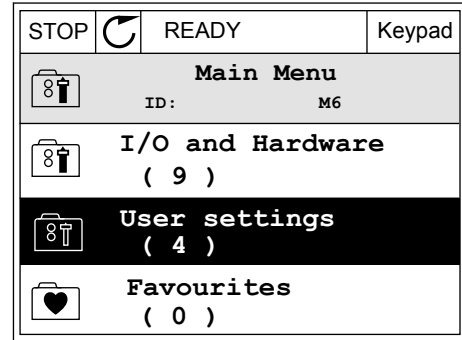

2 Go into the Parameter backup submenu.

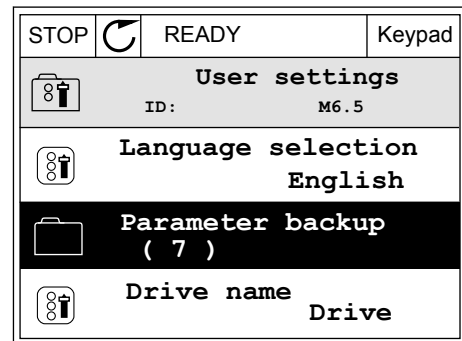

3 Use the arrow buttons Up and Down to make a selection of a function. Accept the selection with the OK button.

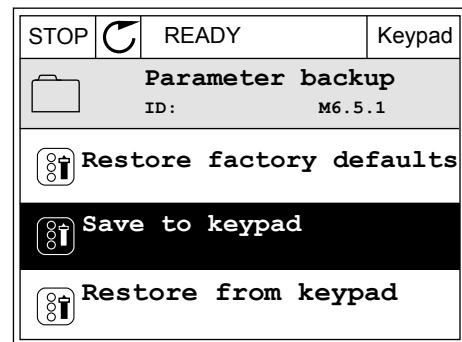

The command Restore factory defaults brings back the parameter settings that were made at the factory. With the command Save to keypad you can copy all the parameters to the control panel. The command Restore from keypad copies all the parameters from the control panel to the drive.

3.2.5 COMPARING THE PARAMETERS

With this function, you can compare the current parameter set with 1 of these 4 sets.

- Set 1 (P6.5.4 Save to Set 1)
- Set 2 (P6.5.6 Save to Set 2)
- The defaults (P6.5.1 Restore Factory Defaults)
- The keypad set (P6.5.2 Save to Keypad)

See more about these parameters in *Table 114 The parameter backup parameters in the user settings menu.*



NOTE!

If you have not saved the parameter set with which you want to compare the current set, the display shows the text *Comparing failed*.

USING THE FUNCTION PARAMETER COMPARE

- 1 Go into Parameter Compare in the User settings menu.

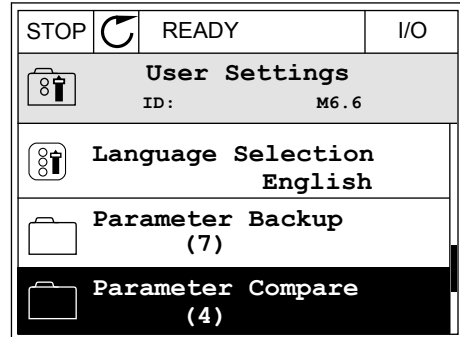

- 2 Make a selection of the pair of sets. Push OK to accept the selection.

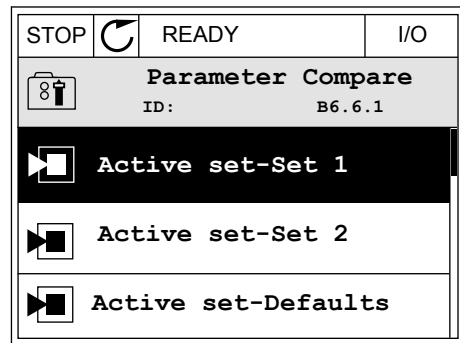

- 3 Make a selection of Active and push OK.

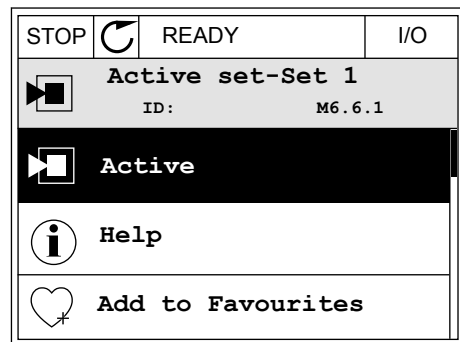

- Examine the comparing between the current values and the values of the other set.

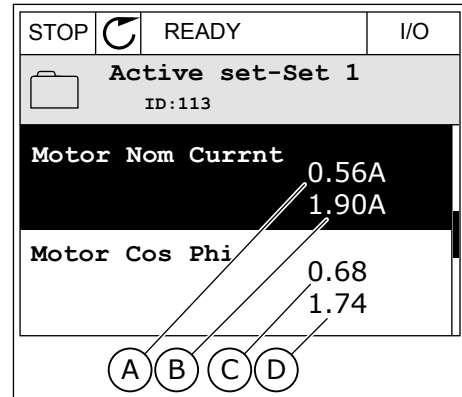

- The current value
- The value of the other set
- The current value
- The value of the other set

3.2.6 HELP TEXTS

The graphical display can show help texts on many topics. All the parameters have a help text.

The help texts are also available for the faults, alarms, and the Startup wizard.

READING A HELP TEXT

- Find the item about which you want to read.

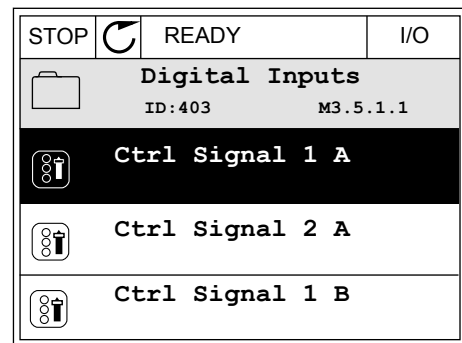

- Use the arrow buttons Up and Down to make a selection of Help.

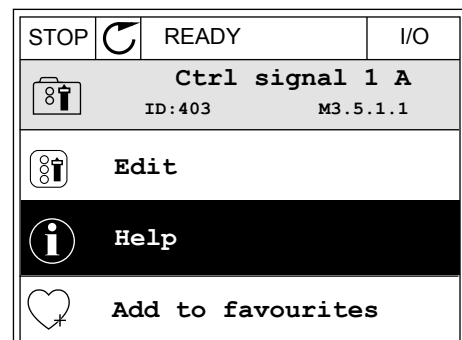

3 To open the help text, push the OK button.

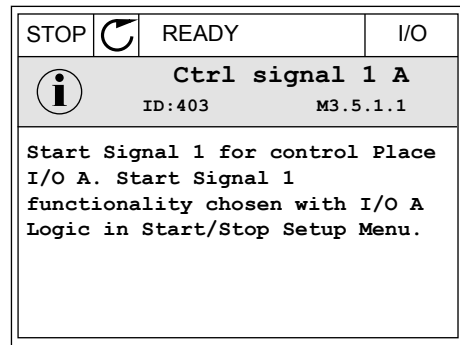

NOTE!

The help texts are always in English.

3.2.7 USING THE FAVOURITES MENU

If you use the same items frequently, you can add them into Favourites. You can collect a set of parameters or monitoring signals from all the keypad menus.

See more about how to use the Favourites menu in Chapter 8.2 *Favourites*.

3.3 USING THE TEXT DISPLAY

You can also have the control panel with the text display for your user interface. The text display and the graphical display have almost the same functions. Some functions are only available in the graphical display.

The display shows the status of the motor and the AC drive. It also shows faults in the operation of the motor and the drive. On the display, you see your current location in the menu. You also see the name of the group or item in your current location. If the text is too long for the display, the text scrolls to show the full text string.

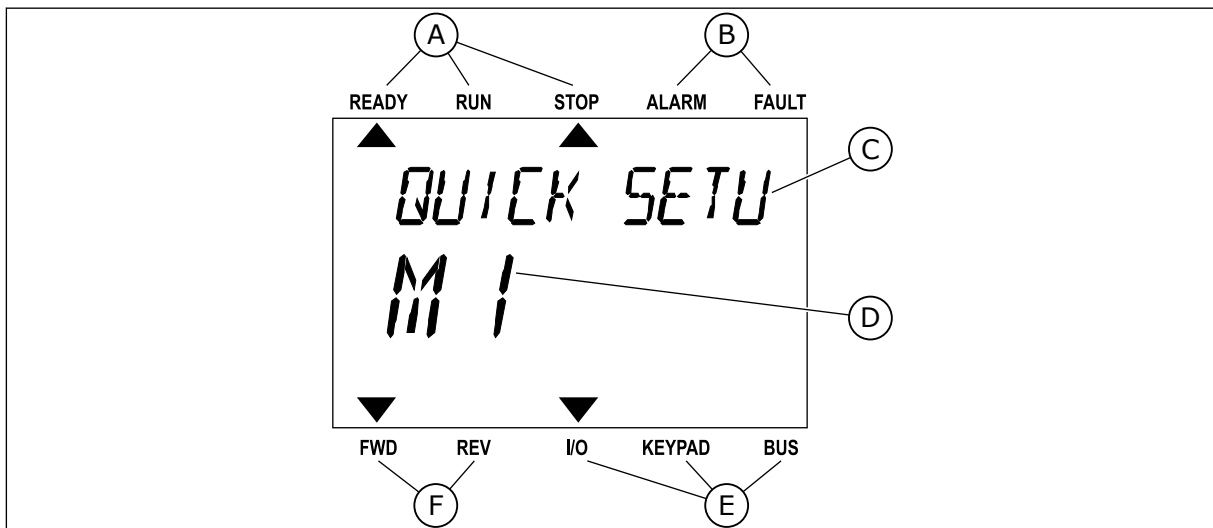

Fig. 34: The main menu of the text display

- A. The indicators of status
- B. The indicators of alarm and fault
- C. The name of the group or item of the current location

- D. The current location in the menu
- E. The indicators of the control place
- F. The indicators of the rotation direction

3.3.1 EDITING THE VALUES

CHANGING THE TEXT VALUE OF A PARAMETER

Set the value of a parameter with this procedure.

- 1 Find the parameter with the arrow buttons.



- 2 To go to the Edit mode, push the OK button.

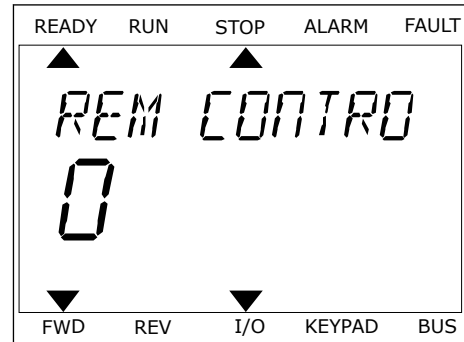

- 3 To set a new value, push the arrow buttons Up and Down.

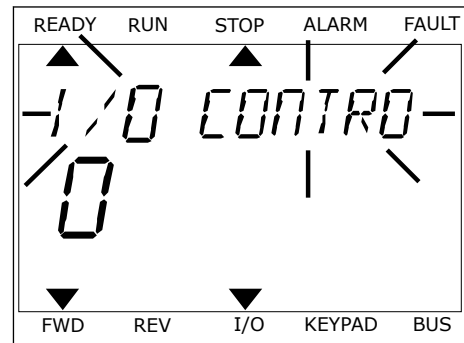

- 4 Accept the change with the OK button. To ignore the change, go back to the level where you were before with the Back/Reset button.

EDITING THE NUMERICAL VALUES

- 1 Find the parameter with the arrow buttons.
- 2 Go to the Edit mode.

- 3 Move from digit to digit with the arrow buttons Left and Right. Change the digits with the arrow buttons Up and Down.
- 4 Accept the change with the OK button. To ignore the change, go back to the level where you were before with the Back/Reset button.

3.3.2 RESETTING A FAULT

To reset a fault, you can use the Reset button or the parameter Reset Faults. See the instructions in *11.1 A fault comes into view*.

3.3.3 THE FUNCT BUTTON

You can use the FUNCT button for 4 functions.

- To have an access to the Control page.
- To easily change between the Local and Remote control places.
- To change the rotation direction.
- To quickly edit a parameter value.

The selection of the control place determines from where the AC drive takes the start and stop commands. All the control places have a parameter for the selection of the frequency reference source. The Local control place is always the keypad. The Remote control place is I/O or Fieldbus. You can see the current control place on the status bar of the display.

It is possible to use I/O A, I/O B and Fieldbus as Remote control places. I/O A and Fieldbus have the lowest priority. You can make a selection of them with P3.2.1 (Remote Control Place). I/O B can bypass the Remote control places I/O A and Fieldbus with a digital input. You can make a selection of the digital input with parameter P3.5.1.7 (I/O B Control Force).

The keypad is always used as a control place when the control place is Local. Local control has higher priority than Remote control. For example, when you are in Remote control, if parameter P3.5.1.7 bypasses the control place with a digital input, and you make a selection of Local, Keypad becomes the control place. Use the FUNCT button or P3.2.2 Local/Remote to change between the Local and Remote control.

CHANGING THE CONTROL PLACE

- 1 Anywhere in the menu structure, push the FUNCT button.

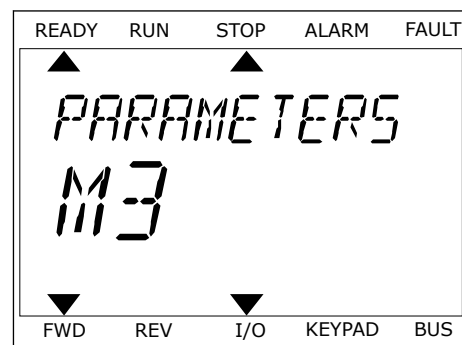

- To make a selection of the Local/Remote, use the arrow buttons Up and Down. Push the OK button.



- To make a selection of Local **or** Remote, use the arrow buttons Up and Down again. To accept the selection, push the OK button.

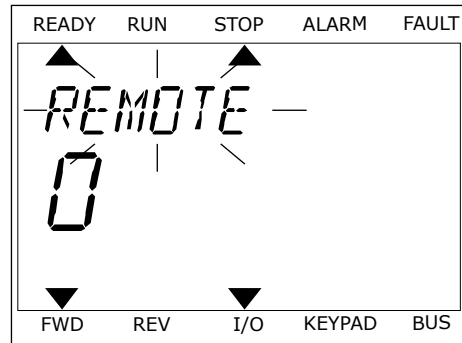

- If you changed Remote control place to Local, that is, the keypad, give a keypad reference.

After the selection, the display goes back into the same location where it was when you pushed the FUNCT button.

GOING INTO THE CONTROL PAGE

It is easy to monitor the most important values in the Control page.

- Anywhere in the menu structure, push the FUNCT button.

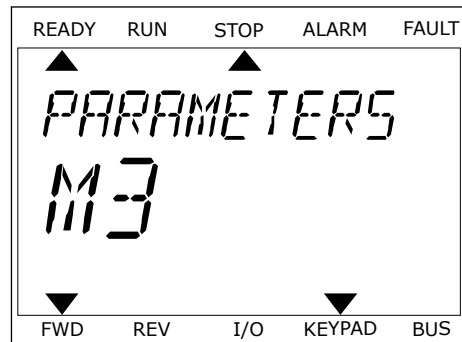

- 2 To make a selection of the Control page, push the arrow buttons Up and Down. Go in with the OK button. The control page opens.

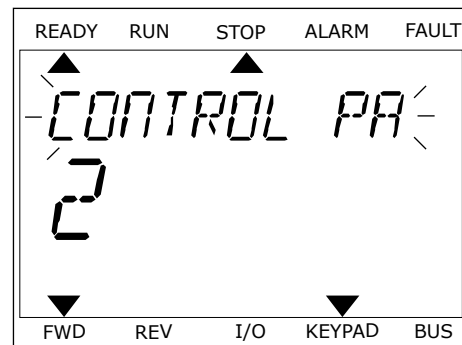

- 3 If you use the Local control place and the keypad reference, you can set P3.3.1.8 Keypad Reference with the OK button.

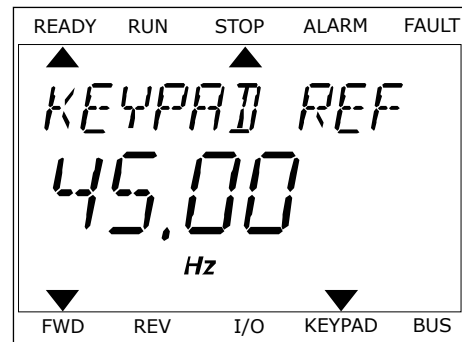

See more information about the Keypad Reference in 5.3 Group 3.3: References). If you use other control places or reference values, the display shows the frequency reference, which you cannot edit. The other values on the page are Multimonitoring values. You can make a selection of the values that show up here (see instructions in 4.1.1 Multimonitor).

CHANGING THE ROTATION DIRECTION

You can change the rotation direction of the motor quickly with the FUNCT button.



NOTE!

The command Change direction is available in the menu only if the current control place is Local.

- 1 Anywhere in the menu structure, push the FUNCT button.
- 2 To make a selection of the Change direction, push the arrow buttons Up and Down. Push the OK button.
- 3 Make a selection of a new rotation direction. The current rotation direction blinks. Push the OK button. The rotation direction changes immediately, and the arrow indication in the status field of the display changes.

THE QUICK EDIT FUNCTION

With the Quick edit function, you can have a quick access to a parameter by typing the ID number of the parameter.

- 1 Anywhere in the menu structure, push the FUNCT button.
- 2 Push the arrow buttons Up and Down to make a selection of Quick Edit and accept with the OK button.
- 3 Write the ID number of a parameter or monitoring value. Push OK. The display shows the parameter value in the edit mode and the monitoring value in the monitoring mode.

3.4 MENU STRUCTURE

Menu	Function
Quick setup	See 1.4 Description of the applications.
Monitor	Multimonitor*
	Trend curve*
	Basic
	I/O
	Extras/Advanced
	Timer functions
	PID controller
	External PID controller
	Multi-pump
	Maintenance counters
	Fiedbus data
Parameters	See 5 Parameters menu.
Diagnostics	Active faults
	Reset faults
	Fault history
	Total counters
	Trip counters
	Software info

Menu	Function
I/O and hardware	User settings
	Slot C
	Slot D
	Slot E
	Real time clock
	Power unit settings
	Keypad
	RS-485
	Ethernet
User settings	Language selections
	Parameter backup*
	Parameter compare
	Drive name
Favourites *	See 8.2 <i>Favourites</i> .
User levels	See 5 <i>Parameters menu</i> .

* = The function is not available in the control panel with a text display.

3.4.1 QUICK SETUP

The Quick Setup group includes the different wizards and quick setup parameters of the VACON® 100 FLOW application. More detailed information on the parameters of this group you will find in chapter 1.3 *First startup* and 2 *Wizards*.

3.4.2 MONITOR

MULTIMONITOR

With the Multimonitor function, you can collect 4 to 9 items to monitor. See 4.1.1 *Multimonitor*.

**NOTE!**

The Multimonitor menu is not available in the text display.

TREND CURVE

The Trend curve function is a graphical presentation of 2 monitor values at the same time. See 4.1.2 *Trend curve*.

BASIC

The basic monitoring values can include statuses, measurements, and the actual values of parameters and signals. See 4.1.3 *Basic*.

I/O

You can monitor the statuses and levels of the values of input and output signals. See 4.1.4 *I/O*.

TEMPERATURE INPUTS

See 4.1.5 *Temperature inputs*.

EXTRAS/ADVANCED

You can monitor different advanced values, for example fieldbus values. See 4.1.6 *Extras and advanced*.

TIMER FUNCTIONS

You can monitor the timer functions and the Real Time Clock. See 4.1.7 *Timer functions monitoring*.

PID CONTROLLER

You can monitor the PID controller values. See 4.1.8 *PID controller monitoring*.

EXTERNAL PID CONTROLLER

You can monitor the values that are related to the external PID controller. See 4.1.9 *External PID controller monitoring*.

MULTI-PUMP

You can monitor the values that are related to the operation of more than 1 drive. See 4.1.10 *Multi-pump monitoring*.

MAINTENANCE COUNTERS

You can monitor the values related to the maintenance counters. See 4.1.11 *Maintenance counters*.

FIELDBUS DATA

You can see the fieldbus data as monitor values. Use this function, for example, during the

fieldbus commissioning. See 4.1.12 *Fieldbus process data monitoring*.

3.5 VACON® LIVE

VACON® Live is a PC tool for commissioning and maintenance of the VACON® 10, VACON® 20, and VACON® 100 Family AC drives. You can download VACON® Live from <http://drives.danfoss.com>.

The VACON® Live PC tool includes these functions.

- Parametrisation, monitoring, drive info, data logger, etc.
- The software download tool VACON® Loader
- Serial communication and Ethernet support
- Windows XP, Vista 7 and 8 support
- 17 languages: English, German, Spanish, Finnish, French, Italian, Russian, Swedish, Chinese, Czech, Danish, Dutch, Polish, Portuguese, Romanian, Slovak and Turkish

You can make the connection between the AC drive and the PC tool with the VACON® serial communication cable. The serial communication drivers are installed automatically during the installation of VACON® Live. After you installed the cable, VACON® Live finds the connected drive automatically.

See more on how to use VACON® Live in the help menu of the program.

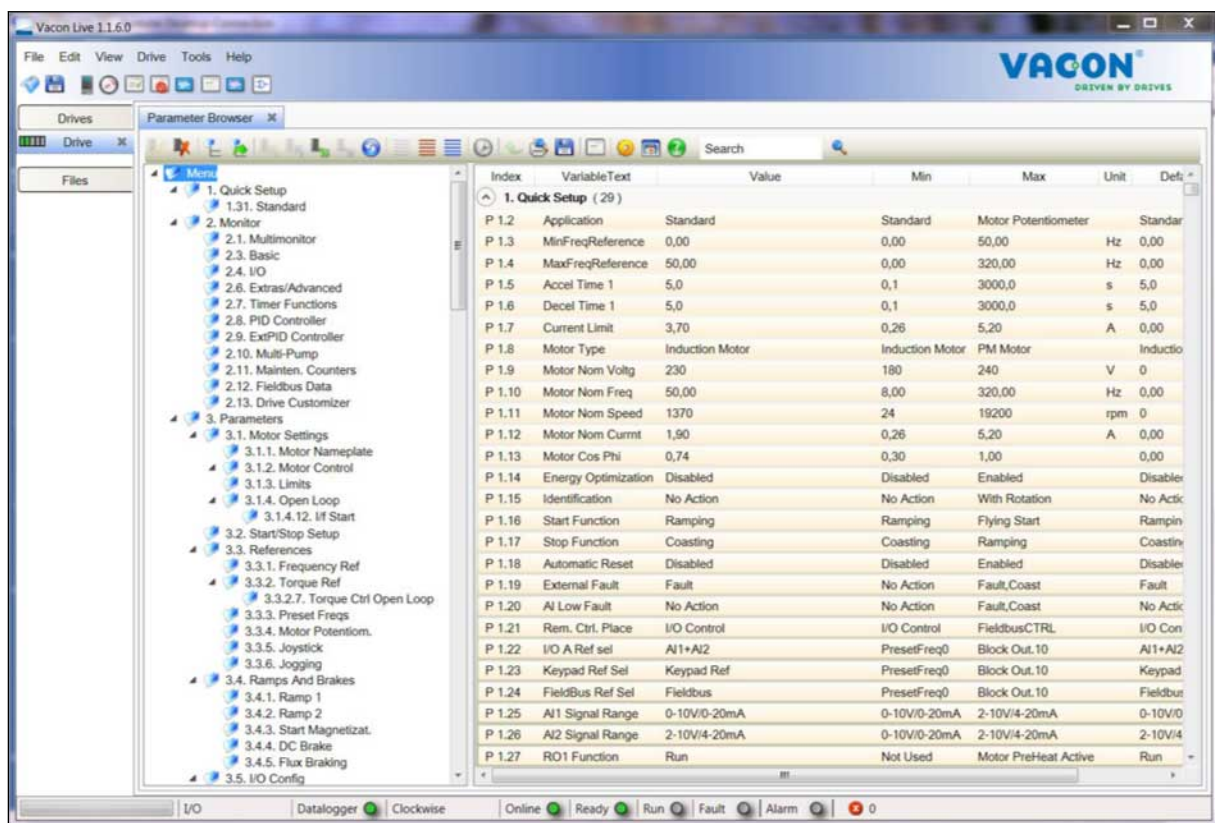

Fig. 35: The VACON® Live PC tool

4 MONITORING MENU

4.1 MONITOR GROUP

You can monitor the actual values of the parameters and signals. You can also monitor the statuses and measurements. You can customise some of the values that you can monitor.

4.1.1 MULTIMONITOR

On the Multimonitor page, you can collect 4 to 9 items to monitor. Make a selection of the number of items with the parameter 3.11.4 Multimonitor View. See more in chapter 5.11 *Group 3.11: Application settings*.

CHANGING THE ITEMS TO MONITOR

1 Go into the Monitor menu with the OK button.

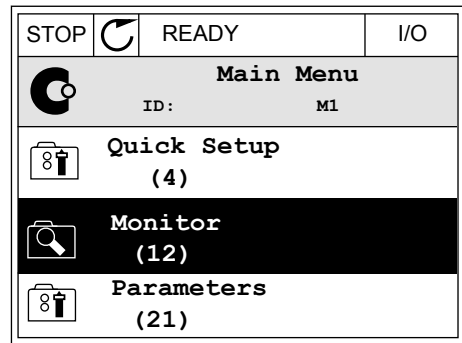

2 Go into Multimonitor.

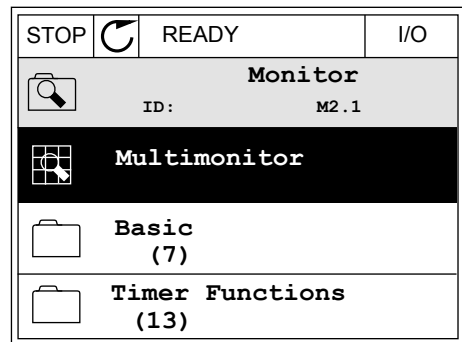

3 To replace an old item, activate it. Use the arrow buttons.

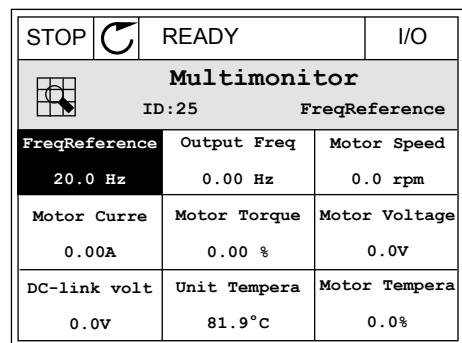

- To make a selection of a new item in the list, push OK.

STOP		READY	I/O
FreqReference			
ID:1		M2.1.1.1	
<input checked="" type="checkbox"/>	Output frequency	0.00 Hz	
<input checked="" type="checkbox"/>	FreqReference	10.00 Hz	
<input checked="" type="checkbox"/>	Motor Speed	0.00 rpm	
<input checked="" type="checkbox"/>	Motor Current	0.00 A	
<input checked="" type="checkbox"/>	Motor Torque	0.00 %	
<input type="checkbox"/>	Motor Power	0.00 %	

4.1.2 TREND CURVE

The Trend curve is a graphical presentation of 2 monitor values.

When you make a selection of a value, the drive starts to record the values. In the Trend curve submenu, you can examine the trend curve, make the signal selections. You can also give the minimum and maximum settings and the sampling interval, and use Autoscaling.

CHANGING THE VALUES

Change the monitoring values with this procedure.

- In the Monitor menu, find the Trend curve submenu and push OK.

STOP		READY	I/O
Monitor			
ID:		M2.2	
	Multimonitor		
	Trend Curve (7)		
	Basic (13)		

- Go into the submenu View trend curve with the OK button.

STOP		READY	I/O
Trend Curve			
ID:		M2.2.1	
	View Trend Curve (2)		
	Sampling interval	100 ms	
	Channel 1 min	-1000	

- 3 You can monitor only 2 values as trend curves at the same time. The current selections, FreqReference and Motor speed, are at the bottom of the display. To make a selection of the current value that you wish to change, use the arrow buttons up and down. Push OK.

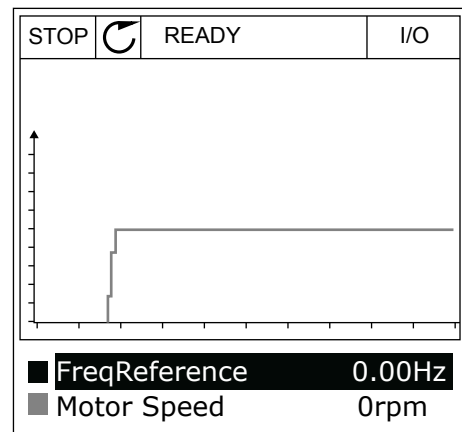

- 4 Go through the list of the monitoring values with the arrow buttons.

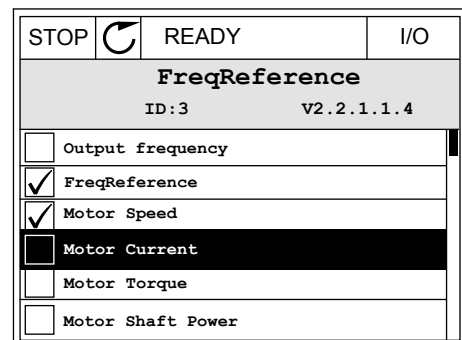

- 5 Make a selection and push OK.

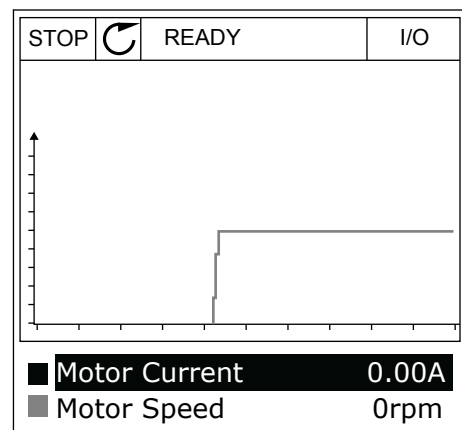

STOPPING THE PROGRESSION OF THE CURVE

The Trend curve function also lets you to stop the curve and read the current values. After, you can start the progression of the curve again.

- 1 In Trend curve view, make a curve active with the arrow button Up. The frame of the display turns bold.

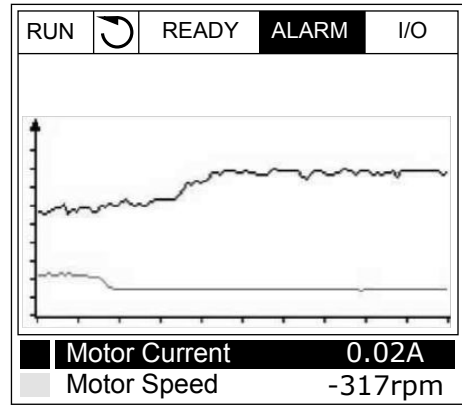

- 2 Push OK at the target point of the curve.

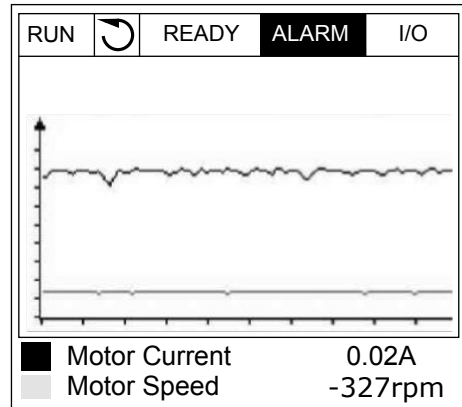

- 3 A vertical line comes into view on the display. The values at the bottom of the display agree to the location of the line.

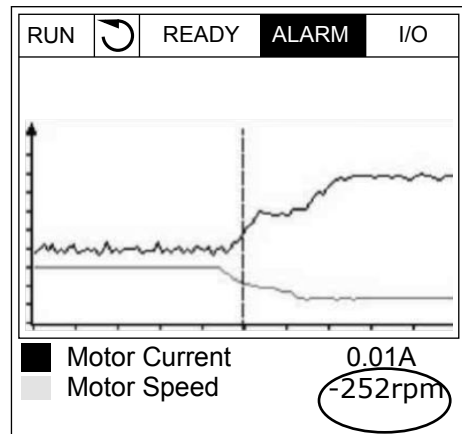

- 4 To move the line to see the values of some other location, use the arrow buttons Left and Right.

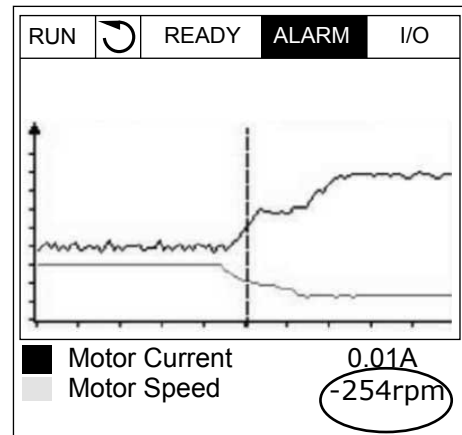

Table 15: The trend curve parameters

Index	Parameter	Min	Max	Unit	Default	ID	Description
M2.2.1	View Trend curve						Go into this menu to monitor values in a curve form.
P2.2.2	Sampling interval	100	432000	ms	100	2368	
P2.2.3	Channel 1 min	-214748	1000		-1000	2369	
P2.2.4	Channel 1 max	-1000	214748		1000	2370	
P2.2.5	Channel 2 min	-214748	1000		-1000	2371	
P2.2.6	Channel 2 max	-1000	214748		1000	2372	
P2.2.7	Autoscale	0	1		0	2373	0 = Disabled 1 = Enabled

4.1.3 BASIC

You can see the basic monitoring values and their related data in the next table.



NOTE!

Only the standard I/O board statuses are available in the Monitor menu. You can find the statuses of all the I/O board signals as raw data in the I/O and Hardware menu.

Do a check of the statuses of the expander I/O board in the I/O and Hardware menu when the system asks you to do it.

Table 16: Items in the monitoring menu

Index	Monitoring value	Unit	Scale	ID	Description
V2.3.1	Output frequency	Hz	0.01	1	
V2.3.2	Frequency reference	Hz	0.01	25	
V2.3.3	Motor speed	rpm	1	2	
V2.3.4	Motor current	A	Varies	3	
V2.3.5	Motor torque	%	0.1	4	
V2.3.7	Motor shaft power	%	0.1	5	
V2.3.8	Motor shaft power	kW/hp	Varies	73	
V2.3.9	Motor voltage	V	0.1	6	
V2.3.10	DC link voltage	V	1	7	
V2.3.11	Unit temperature	°C	0.1	8	
V2.3.12	Motor temperature	%	0.1	9	
V2.3.13	Motor Preheat		1	1228	0 = OFF 1 = Heating (feeding DC-current)
V2.3.15	kWh Trip Counter Low	kWh	1	1054	
V2.3.14	kWh Trip Counter High		1	1067	

4.1.4 I/O

Table 17: I/O signal monitoring

Index	Monitoring value	Unit	Scale	ID	Description
V2.4.1	Slot A DIN 1, 2, 3		1	15	
V2.4.2	Slot A DIN 4, 5, 6		1	16	
V2.4.3	Slot B RO 1, 2, 3		1	17	
V2.4.4	Analogue input 1	%	0.01	59	Slot A.1 as default.
V2.4.5	Analogue input 2	%	0.01	60	Slot A.2 as default.
V2.4.6	Analogue input 3	%	0.01	61	Slot D.1 as default.
V2.4.7	Analogue input 4	%	0.01	62	Slot D.2 as default.
V2.4.8	Analogue input 5	%	0.01	75	Slot E.1 as default.
V2.4.9	Analogue input 6	%	0.01	76	Slot E.2 as default.
V2.4.10	Slot A AO1	%	0.01	81	

4.1.5 TEMPERATURE INPUTS

**NOTE!**

This parameter group is visible when you have an option board for temperature measurement (OPT-BH).

Table 18: Monitoring the temperature inputs

Index	Monitoring value	Unit	Scale	ID	Description
V2.5.1	Temperature input 1	°C	0.1	50	
V2.5.2	Temperature input 2	°C	0.1	51	
V2.5.3	Temperature input 3	°C	0.1	52	
V2.5.4	Temperature input 4	°C	0.1	69	
V2.5.5	Temperature input 5	°C	0.1	70	
V2.5.6	Temperature input 6	°C	0.1	71	

4.1.6 EXTRAS AND ADVANCED

Table 19: Monitoring of the advanced values

Index	Monitoring value	Unit	Scale	ID	Description
V2.6.1	Drive Status Word		1	43	B1 = Ready B2 = Run B3 = Fault B6 = RunEnable B7 = AlarmActive B10 = DC current in stop B11 = DC brake active B12 = RunRequest B13 = MotorRegulatorActive B15 = Brake Chopper Active
V2.6.2	Ready Status		1	78	B0 = Run Enable active B1 = No fault B2 = Charge switch closed B3 = DC voltage OK B4 = Power unit OK B5 = Start allowed (Power unit) B6 = Start allowed (System software)
V2.6.3	Application Status Word1		1	89	B0 = Run Interlock 1 B1 = Run Interlock 2 B2 = Ramp 2 active B3 = Reserved B4 = I/O A control active B5 = I/O B control active B6 = Fieldbus control Active B7 = Local control active B8 = PC control active B9 = Preset frequencies active B10 = Flushing active B11 = Fire Mode active B12 = Motor Preheat active B13 = Quick stop active B14 = Stopped from keypad
V2.6.4	Application Status Word2		1	90	B0 = Acc/Dec prohibited B1 = Motor switch open B2 = PID running B3 = PID sleep B4 = PID soft fill B5 = Autocleaning active B6 = Jockey pump B7 = Priming pump B8 = Anti-blocking B9 = Input pressure alarm B10 = Frost protection alarm B11 = Overpressure alarm B14 = Supervision 1 B15 = Supervision 2
V2.6.5	DIN Status Word 1		1	56	
V2.6.6	DIN Status Word 2		1	57	

Table 19: Monitoring of the advanced values

Index	Monitoring value	Unit	Scale	ID	Description
V2.6.7	Motor Current 1 Decimal		0.1	45	
V2.6.8	Frequency Reference Source		1	1495	0 = PC 1 = Preset Freqs 2 = Keypad Reference 3 = Fieldbus 4 = AI1 5 = AI2 6 = AI1+AI2 7 = PID Controller 8 = Motor Potentiom. 10 = Flushing 11 = Block Out.1 12 = Block Out.2 13 = Block Out.3 14 = Block Out.4 15 = Block Out.5 16 = Block Out.6 17 = Block Out.7 18 = Block Out.8 19 = Block Out.9 20 = Block Out.10 100 = Not defined 101 = Alarm, PresetFreq 102 = Autocleaning
V2.6.9	Last Active Fault Code		1	37	
V2.6.10	Last Active Fault ID		1	95	
V2.6.11	Last Active Alarm Code		1	74	
V2.6.12	Last Active Alarm ID		1	94	
V2.6.13	Motor Regulator Status		1	77	B0 = Current Limit (Motor) B1 = Current Limit (Generator) B2 = Torque Limit (Motor) B3 = Torque Limit (Generator) B4 = Overvoltage Control B5 = Undervoltage Control B6 = Power Limit (Motor) B7 = Power Limit (Generator)
V2.6.14	Motor Shaft Power 1 Deceleration	kW/hp		98	

4.1.7 TIMER FUNCTIONS MONITORING

Monitor the values of Timer functions and the Real Time Clock.

Table 20: Monitoring of the timer functions

Index	Monitoring value	Unit	Scale	ID	Description
V2.7.1	TC 1, TC 2, TC 3		1	1441	
V2.7.2	Interval 1		1	1442	
V2.7.3	Interval 2		1	1443	
V2.7.4	Interval 3		1	1444	
V2.7.5	Interval 4		1	1445	
V2.7.6	Interval 5		1	1446	
V2.7.7	Timer 1	s	1	1447	
V2.7.8	Timer 2	s	1	1448	
V2.7.9	Timer 3	s	1	1449	
V2.7.10	Real time clock			1450	

4.1.8 PID CONTROLLER MONITORING

Table 21: Monitoring of the values of the PID controller

Index	Monitoring value	Unit	Scale	ID	Description
V2.8.1	PID Setpoint	Varies	As is set in P3.13.1.7	20	
V2.8.2	PID Feedback	Varies	As is set in P3.13.1.7	21	
V2.8.3	PID Feedback (1)	Varies	As is set in P3.13.1.7	15541	
V2.8.4	PID Feedback (2)	Varies	As is set in P3.13.1.7	15542	
V2.8.5	PID Error	Varies	As is set in P3.13.1.7	22	
V2.8.6	PID Output	%	0.01	23	
V2.8.7	PID Status		1	24	0 = Stopped 1 = Running 3 = Sleep mode 4 = In dead band (see 5.13 Group 3.13: PID controller)

4.1.9 EXTERNAL PID CONTROLLER MONITORING

Table 22: Monitoring of the values of the external PID controller

Index	Monitoring value	Unit	Scale	ID	Description
V2.9.1	ExtPID Setpoint	Varies	As set in P3.14.1.1 0 (See 5.14 Group 3.14: External PID controller)	83	
V2.9.2	ExtPID Feedback	Varies	As set in P3.14.1.1 0	84	
V2.9.3	ExtPID Error	Varies	As set in P3.14.1.1 0	85	
V2.9.4	ExtPID Output	%	0.01	86	
V2.9.5	ExtPID Status		1	87	0=Stopped 1=Running 2=In dead band (see 5.14 Group 3.14: External PID controller)

4.1.10 MULTI-PUMP MONITORING

You can use the monitoring values from Pump 2 Running Time to Pump 8 Running Time in the Multi-pump (single drive) mode.

If you use Multimaster or Multifollower mode, read the value of the pump runtime counter from the monitoring value Pump (1) Running Time. Read the pump runtime from each drive.

Table 23: Multi-pump monitoring

Index	Monitoring value	Unit	Scale	ID	Description
V2.10.1	Motors Running		1	30	
V2.10.2	Autochange		1	1114	
V2.10.3	Next Autochange	h	0.1	1503	
V2.10.4	Operate Mode		1	1505	0 = Slave 1 = Master
V2.10.5	Multi-pump Status		1	1628	0 = Not used 10 = Stopped 20 = Sleep 30 = Anti-blocking 40 = Auto-cleaning 50 = Flushing 60 = Soft filling 70 = Regulating 80 = Following 90 = Const. producing 200 = Unknown
V2.10.6	Communication Status	h	0.1	1629	0 = Not used (Multi-pump multidrive function) 10 = Fatal communication errors occurred (or no communication) 11 = Errors occurred (data sending) 12 = Errors occurred (data receiving) 20 = Communication operational, no errors occurred 30 = Status unknown
V2.10.7	Pump (1) Running Time	h	0.1	1620	
V2.10.8	Pump 2 Running Time	h	0.1	1621	
V2.10.9	Pump 3 Running Time	h	0.1	1622	
V2.10.10	Pump 4 Running Time	h	0.1	1623	
V2.10.11	Pump 5 Running Time	h	0.1	1624	
V2.10.12	Pump 6 Running Time	h	0.1	1625	
V2.10.13	Pump 7 Running Time	h	0.1	1626	
V2.10.14	Pump 8 Running Time	h	0.1	1627	

4.1.11 MAINTENANCE COUNTERS

Table 24: Maintenance counter monitoring

Index	Monitoring value	Unit	Scale	ID	Description
V2.11.1	Maintenance counter 1	h/ kRev	Varies	1101	

4.1.12 FIELDBUS PROCESS DATA MONITORING

Table 25: Fieldbus process data monitoring

Index	Monitoring value	Unit	Scale	ID	Description
V2.12.1	FB Control Word		1	874	
V2.12.2	FB Speed Reference		Varies	875	
V2.12.3	FB data in 1		1	876	
V2.12.4	FB data in 2		1	877	
V2.12.5	FB data in 3		1	878	
V2.12.6	FB data in 4		1	879	
V2.12.7	FB data in 5		1	880	
V2.12.8	FB data in 6		1	881	
V2.12.9	FB data in 7		1	882	
V2.12.10	FB data in 8		1	883	
V2.12.11	FB Status Word		1	864	
V2.12.12	FB Speed Actual		0.01	865	
V2.12.13	FB data out 1		1	866	
V2.12.14	FB data out 2		1	867	
V2.12.15	FB data out 3		1	868	
V2.12.16	FB data out 4		1	869	
V2.12.17	FB data out 5		1	870	
V2.12.18	FB data out 6		1	871	
V2.12.19	FB data out 7		1	872	
V2.12.20	FB data out 8		1	873	

4.1.13 DRIVE CUSTOMIZER MONITORING

Table 26: Drive customizer monitoring

Index	Monitoring value	Unit	Scale	ID	Description
V2.13.2	Block Out.1			15020	
V2.13.3	Block Out.2			15040	
V2.13.4	Block Out.3			15060	
V2.13.5	Block Out.4			15080	
V2.13.6	Block Out.5			15100	
V2.13.7	Block Out.6			15120	
V2.13.8	Block Out.7			15140	
V2.13.9	Block Out.8			15160	
V2.13.10	Block Out.9			15180	
V2.13.11	Block Out.10			15200	

5 PARAMETERS MENU

You can change and edit the parameters in the Parameters menu (M3) at all times.

5.1 GROUP 3.1: MOTOR SETTINGS

Table 27: Motor nameplate parameters

Index	Parameter	Min	Max	Unit	Default	ID	Description
P3.1.1.1	Motor Nominal Voltage	Varies	Varies	V	Varies	110	
P3.1.1.2	Motor Nominal Frequency	8.00	320.00	Hz	50 / 60	111	
P3.1.1.3	Motor Nominal Speed	24	19200	rpm	Varies	112	
P3.1.1.4	Motor Nominal Current	I _H * 0.1	I _H * 2	A	Varies	113	
P3.1.1.5	Motor Cos Phi (Power Factor)	0.30	1.00		Varies	120	
P3.1.1.6	Motor Nominal Power	Varies	Varies	kW	Varies	116	

Table 28: Motor control settings

Index	Parameter	Min	Max	Unit	Default	ID	Description
P3.1.2.2	Motor Type	0	1		0	650	0 = Induction motor 1 = PM motor 2 = Reluctance motor
P3.1.2.3	Switching Frequency	1.5	Varies	kHz	Varies	601	
P3.1.2.4	Identification	0	2		0	631	0 = No action 1 = At standstill 2 = With rotation
P3.1.2.5	Magnetising Current	0.0	2*I _H	A	0.0	612	
P3.1.2.6	Motor Switch	0	1		0	653	0 = Disabled 1 = Enabled
P3.1.2.10	Overvoltage Control	0	1		1	607	0 = Disabled 1 = Enabled
P3.1.2.11	Undervoltage Control	0	1		1	608	0 = Disabled 1 = Enabled
P3.1.2.12	Energy Optimisation	0	1		0	666	0 = Disabled 1 = Enabled
P3.1.2.13	Stator Voltage Adjust	50.0	150.0	%	100.0	659	
P3.1.2.15	R _s Voltage Drop	0.00	50.00	%	0.00	662	
P3.1.2.16	L _s Voltage Drop	0.00	200.00	%	0.00	673	
P3.1.2.17	Motor BEM Voltage	0	Varies	V	0	674	

Table 29: Motor limit settings

Index	Parameter	Min	Max	Unit	Default	ID	Description
P3.1.3.1	Motor Current Limit	I _H *0.1	I _S	A	Varies	107	
P3.1.3.2	Motor Torque Limit	0.0	300.0	%	300.0	1287	

Table 30: Open loop settings

Index	Parameter	Min	Max	Unit	Default	ID	Description
P3.1.4.1	U/f Ratio	0	2		0	108	0=Linear 1=Squared 2=Programmable
P3.1.4.2	Field Weakening Point Frequency	8.00	P3.3.1.2	Hz	Varies	602	
P3.1.4.3	Voltage at Field Weakening Point	10.00	200.00	%	100.00	603	
P3.1.4.4	U/f Midpoint Frequency	0.00	P3.1.4.2.	Hz	Varies	604	
P3.1.4.5	U/f Midpoint Voltage	0.0	100.0	%	100.0	605	
P3.1.4.6	Zero Frequency Voltage	0.00	40.00	%	Varies	606	
P3.1.4.7	Flying Start Options	0	255		0	1590	B0 = Search the shaft frequency only from the same direction as the frequency reference B1 = Disable AC scanning B4 = Use the frequency reference for the initial guess B5 = Disable DC pulses B6 = Flux build with current control B7 = Reverse injection direction
P3.1.4.8	Flying Start Scan Current	0.0	100.0	%	Varies	1610	
P3.1.4.9	Start Boost	0	1		0	109	0=Disabled 1=Enabled
M3.1.4.12	I/f Start	This menu includes 3 parameters. See the table below.					

Table 31: I/f start parameters

Index	Parameter	Min	Max	Unit	Default	ID	Description
P3.1.4.12.1	I/f Start	0	1		0	534	0 = Disabled 1 = Enabled
P3.1.4.12.2	I/f Start Frequency	5.0	0.5 * P3.1.1.2		0.2 * P3.1.1.2	535	
P3.1.4.12.3	I/f Start Current	0.0	150.0	%	80.0	536	

Table 32: Torque stabilator parameters

Index	Parameter	Min	Max	Unit	Default	ID	Description
P3.1.4.13.1	Torque Stabilator Gain	0.0	500.0	%	50.0	1412	
P3.1.4.13.2	Torque Stabilator Gain at Field Weakening Point	0.0	500.0	%	50.0	1414	
P3.1.4.13.3	Torque Stabilator Damping Time Constant	0.0005	1.0000	s	0.0050	1413	
P3.1.4.13.4	Torque Stabilator Damping Time Constant for PM motors	0.0005	1.0000	s	0.0050	1735	
P3.1.4.13.5	Torque Stabilator Filter Time Constant	0.0000	0.5000	s	0.0005	15650	
P3.1.4.13.6	Torque Stabilator Filter Time Constant for PM motors	0.0000	0.5000	s	0.0005	15651	

5.2 GROUP 3.2: START/STOP SETUP

Table 33: Start/stop setup menu

Index	Parameter	Min	Max	Unit	Default	ID	Description
P3.2.1	Remote Control Place	0	1		0 *	172	0 = I/O control 1 = Fieldbus control
P3.2.2	Local/Remote	0	1		0 *	211	0 = Remote 1 = Local
P3.2.3	Keypad Stop Button	0	1		0	114	0 = Yes 1 = No
P3.2.4	Start Function	0	1		0	505	0 = Ramping 1 = Flying start
P3.2.5	Stop Function	0	1		0	506	0 = Coasting 1 = Ramping
P3.2.6	I/O A Start/Stop Logic	0	4		2 *	300	<p>Logic = 0</p> <p>Ctrl sgn 1 = Forward Ctrl sgn 2 = Backward</p> <p>Logic = 1</p> <p>Ctrl sgn 1 = Forward (edge) Ctrl sgn 2 = Inverted Stop Ctrl sgn 3 = Bckwrđ (edge)</p> <p>Logic = 2</p> <p>Ctrl sgn 1 = Forward (edge) Ctrl sgn 2 = Bckwrđ (edge)</p> <p>Logic = 3</p> <p>Ctrl sgn 1 = Start Ctrl sgn 2 = Reverse</p> <p>Logic = 4</p> <p>Ctrl sgn 1 = Start (edge) Ctrl sgn 2 = Reverse</p>
P3.2.7	I/O B Start/Stop Logic	0	4		2 *	363	See above.

Table 33: Start/stop setup menu

Index	Parameter	Min	Max	Unit	Default	ID	Description
P3.2.8	Fieldbus Start Logic	0	1		0	889	0 = A rising edge is necessary 1 = State
P3.2.9	Start Delay	0.000	60.000	s	0.000	524	
P3.2.10	Remote to Local Function	0	2		2	181	0 = Keep Run 1 = Keep Run & Reference 2 = Stop
P3.2.11	Restart Delay	0.0	20.0	min	0.0	15555	0 = Not used

* = The selection of the application with parameter P1.2 Application gives the default value. See the default values in Chapter 12.1 *The default values of parameters in the different applications.*

5.3 GROUP 3.3: REFERENCES

Table 34: Frequency reference parameters

Index	Parameter	Min	Max	Unit	Default	ID	Description
P3.3.1.1	Minimum Frequency Reference	0.00	P3.3.1.2	Hz	0.00	101	
P3.3.1.2	Maximum Frequency Reference	P3.3.1.1	320.00	Hz	50.00 / 60.00	102	
P3.3.1.3	Positive Frequency Reference Limit	-320.0	320.0	Hz	320.00	1285	
P3.3.1.4	Negative Frequency Reference Limit	-320.0	320.0	Hz	-320.00	1286	
P3.3.1.5	I/O Control Reference A Selection	0	20		6 *	117	0 = PC 1 = Preset frequency 0 2 = Keypad reference 3 = Fieldbus 4 = AI1 5 = AI2 6 = AI1+AI2 7 = PID 8 = Motor potentiometer 11 = Block Out.1 12 = Block Out.2 13 = Block Out.3 14 = Block Out.4 15 = Block Out.5 16 = Block Out.6 17 = Block Out.7 18 = Block Out.8 19 = Block Out.9 20 = Block Out.10
P3.3.1.6	I/O Control Reference B Selection	0	20		4 *	131	

Table 34: Frequency reference parameters

Index	Parameter	Min	Max	Unit	Default	ID	Description
P3.3.1.7	Keypad Control Reference Selection	0	20		1 *	121	0 = PC 1 = Preset frequency 0 2 = Keypad reference 3 = Fieldbus 4 = AI1 5 = AI2 6 = AI1+AI2 7 = PID 8 = Motor potentiometer 11 = Block Out.1 12 = Block Out.2 13 = Block Out.3 14 = Block Out.4 15 = Block Out.5 16 = Block Out.6 17 = Block Out.7 18 = Block Out.8 19 = Block Out.9 20 = Block Out.10
P3.3.1.8	Keypad Reference	0.00	P3.3.1.2.	Hz	0.00	184	
P3.3.1.9	Keypad Direction	0	1		0	123	0 = Forward 1 = Reverse
P3.3.1.10	Fieldbus Control Reference Selection	0	20		2 *	122	0 = PC 1 = Preset frequency 0 2 = Keypad reference 3 = Fieldbus 4 = AI1 5 = AI2 6 = AI1+AI2 7 = PID 8 = Motor potentiometer 11 = Block Out.1 12 = Block Out.2 13 = Block Out.3 14 = Block Out.4 15 = Block Out.5 16 = Block Out.6 17 = Block Out.7 18 = Block Out.8 19 = Block Out.9 20 = Block Out.10

* = The selection of the application with parameter P1.2 Application gives the default value. See the default values in Chapter 12.1 *The default values of parameters in the different applications.*

Table 35: Preset frequency parameters

Index	Parameter	Min	Max	Unit	Default	ID	Description
P3.3.3.1	Preset Frequency Mode	0	1		0 *	182	0 = Binary coded 1 = Number of inputs
P3.3.3.2	Preset Frequency 0	P3.3.1.1	P3.3.1.2	Hz	5.00	180	
P3.3.3.3	Preset Frequency 1	P3.3.1.1	P3.3.1.2	Hz	10.00 *	105	
P3.3.3.4	Preset Frequency 2	P3.3.1.1	P3.3.1.2	Hz	15.00 *	106	
P3.3.3.5	Preset Frequency 3	P3.3.1.1	P3.3.1.2	Hz	20.00 *	126	
P3.3.3.6	Preset Frequency 4	P3.3.1.1	P3.3.1.2	Hz	25.00 *	127	
P3.3.3.7	Preset Frequency 5	P3.3.1.1	P3.3.1.2	Hz	30.00 *	128	
P3.3.3.8	Preset Frequency 6	P3.3.1.1	P3.3.1.2	Hz	40.00 *	129	
P3.3.3.9	Preset Frequency 7	P3.3.1.1	P3.3.1.2	Hz	50.00 *	130	
P3.3.3.10	Preset Frequency Selection 0				DigIN SlotA.4	419	
P3.3.3.11	Preset Frequency Selection 1				DigIN SlotA.5	420	
P3.3.3.12	Preset Frequency Selection 2				DigIN Slot0.1	421	

* The default value of the parameter is specified by the application that you select with parameter P1.2 Application. See the default values in Chapter 12.1 *The default values of parameters in the different applications.*

Table 36: Motor potentiometer parameters

Index	Parameter	Min	Max	Unit	Default	ID	Description
P3.3.4.1	Motor Potentiometer UP				DigIN Slot0.1	418	OPEN = Not active CLOSED = Active
P3.3.4.2	Motor Potentiometer DOWN				DigIN Slot0.1	417	OPEN = Not active CLOSED = Active
P3.3.4.3	Motor Potentiometer Ramp Time	0.1	500.0	Hz/s	10.0	331	
P3.3.4.4	Motor Potentiometer Reset	0	2		1	367	0 = No reset 1 = Reset if stopped 2 = Reset if powered down

Table 37: Flushing parameters

Index	Parameter	Min	Max	Unit	Default	ID	Description
P3.3.6.1	Flushing Reference Activation				DigIN Slot0.1 *	530	
P3.3.6.2	Flushing reference	-MaxRef	MaxRef	Hz	0.00 *	1239	

* The default value of the parameter is specified by the application that you select with parameter P1.2 Application. See the default values in Chapter 12.1 *The default values of parameters in the different applications.*

5.4 GROUP 3.4: RAMPS AND BRAKES SETUP

Table 38: Ramp 1 setup

Index	Parameter	Min	Max	Unit	Default	ID	Description
P3.4.1.1	Ramp 1 Shape	0.0	100.0	%	0.0	500	
P3.4.1.2	Acceleration Time 1	0.1	3000.0	s	5.0	103	
P3.4.1.3	Deceleration Time 1	0.1	3000.0	s	5.0	104	

Table 39: Ramp 2 setup

Index	Parameter	Min	Max	Unit	Default	ID	Description
P3.4.2.1	Ramp 2 Shape	0.0	100.0	%	0.0	501	
P3.4.2.2	Acceleration Time 2	0.1	3000.0	s	10.0	502	
P3.4.2.3	Deceleration Time 2	0.1	3000.0	s	10.0	503	
P3.4.2.4	Ramp 2 Selection	Varies	Varies		DigIN Slot0.1	408	OPEN = Ramp 1 Shape, Acceleration Time 1 and Deceleration Time 1. CLOSED = Ramp 2 Shape, Acceleration Time 2 and Deceleration Time 2.
P3.4.2.5	Ramp 2 Threshold Frequency	0.0	P3.3.1.2	Hz	0.0	533	0 = Not used

Table 40: Start magnetisation parameters

Index	Parameter	Min	Max	Unit	Default	ID	Description
P3.4.3.1	Start Magnetising Current	0.00	IL	A	IH	517	0 = Disabled
P3.4.3.2	Start Magnetising Time	0.00	600.00	s	0.00	516	

Table 41: DC brake parameters

Index	Parameter	Min	Max	Unit	Default	ID	Description
P3.4.4.1	DC Brake Current	0	IL	A	IH	507	0 = Disabled
P3.4.4.2	DC Braking Time at Stop	0.00	600.00	s	0.00	508	0 = DC braking not used
P3.4.4.3	Frequency to Start DC Braking at Ramp Stop	0.10	10.00	Hz	1.50	515	

Table 42: Flux braking parameters

Index	Parameter	Min	Max	Unit	Default	ID	Description
P3.4.5.1	Flux Braking	0	1		0	520	0 = Disabled 1 = Enabled
P3.4.5.2	Flux Braking Current	0	IL	A	IH	519	

5.5 GROUP 3.5: I/O CONFIGURATION

Table 43: Digital input settings

Index	Parameter	Default	ID	Description
P3.5.1.1	Control Signal 1 A	DigIN SlotA.1 *	403	
P3.5.1.2	Control Signal 2 A	DigIN SlotA.2 *	404	
P3.5.1.3	Control Signal 3 A	DigIN Slot0.1	434	
P3.5.1.4	Control Signal 1 B	DigIN Slot0.1 *	423	
P3.5.1.5	Control Signal 2 B	DigIN Slot0.1	424	
P3.5.1.6	Control Signal 3 B	DigIN Slot0.1	435	
P3.5.1.7	I/O B Control Force	DigIN Slot0.1 *	425	
P3.5.1.8	I/O B Reference Force	DigIN Slot0.1 *	343	
P3.5.1.9	Fieldbus Control Force	DigIN Slot0.1 *	411	
P3.5.1.10	Keypad Control Force	DigIN Slot0.1 *	410	
P3.5.1.11	External Fault Close	DigIN SlotA.3 *	405	OPEN = OK CLOSED = External fault
P3.5.1.12	External Fault Open	DigIN Slot0.2	406	OPEN = External fault CLOSED = OK
P3.5.1.13	Fault Reset Close	Varies	414	CLOSED = Resets all active faults.
P3.5.1.14	Fault Reset Open	DigIN Slot0.1	213	OPEN = Resets all active faults.
P3.5.1.15	Run Enable	DigIN Slot0.2	407	
P3.5.1.16	Run Interlock 1	DigIN Slot0.2	1041	OPEN = Start not permitted CLOSED = Start permitted
P3.5.1.17	Run Interlock 2	DigIN Slot0.2	1042	As above.
P3.5.1.18	Motor Preheat ON	DigIN Slot0.1	1044	OPEN = No action. CLOSED = Uses the DC current of the motor preheat in the Stop state. Used when the value of P3.18.1 is 2.
P3.5.1.19	Ramp 2 Selection	DigIN Slot0.1	408	OPEN = Ramp 1 Shape, Acceleration Time 1 and Deceleration Time 1. CLOSED = Ramp 2 Shape, Acceleration Time 2 and Deceleration Time 2.
P3.5.1.20	Acc/Dec Prohibit	DigIN Slot0.1	415	
P3.5.1.21	Preset Frequency Selection 0	DigIN SlotA.4 *	419	
P3.5.1.22	Preset Frequency Selection 1	Varies	420	

Table 43: Digital input settings

Index	Parameter	Default	ID	Description
P3.5.1.23	Preset Frequency Selection 2	DigIN Slot0.1 *	421	
P3.5.1.24	Motor Potentiometer UP	DigIN Slot0.1	418	OPEN = Not active CLOSED = Active
P3.5.1.25	Motor Potentiometer DOWN	DigIN Slot0.1	417	OPEN = Not active CLOSED = Active
P3.5.1.26	Quick Stop Activation	Varies	1213	OPEN = Activated
P3.5.1.27	Timer 1	DigIN Slot0.1	447	
P3.5.1.28	Timer 2	DigIN Slot0.1	448	
P3.5.1.29	Timer 3	DigIN Slot0.1	449	
P3.5.1.30	PID Setpoint Boost	DigIN Slot0.1	1046	OPEN = No boost CLOSED = Boost
P3.5.1.31	PID Setpoint Selection	DigIN Slot0.1 *	1047	OPEN = Setpoint 1 CLOSED = Setpoint 2
P3.5.1.32	External PID Start Signal	DigIN Slot0.2	1049	OPEN = PID2 in stop mode CLOSED = PID2 regulating
P3.5.1.33	External PID Setpoint Selection	DigIN Slot0.1	1048	OPEN = Setpoint 1 CLOSED = Setpoint 2
P3.5.1.34	Reset Maintenance Counter 1	DigIN Slot0.1	490	CLOSED = Reset
P3.5.1.36	Flushing Reference Activation	DigIN Slot0.1 *	530	
P3.5.1.38	Fire Mode Activation OPEN	DigIN Slot0.2	1596	OPEN = Fire mode active CLOSED = No action
P3.5.1.39	Fire Mode Activation CLOSE	DigIN Slot0.1	1619	OPEN = No action CLOSED = Fire Mode active
P3.5.1.40	Fire Mode Reverse	DigIN Slot0.1	1618	OPEN = Forward CLOSED = Reverse
P3.5.1.41	Auto-cleaning Activation	DigIN Slot0.1	1715	
P3.5.1.42	Pump 1 Interlock	DigIN Slot0.1 *	426	OPEN = Not active CLOSED = Active
P3.5.1.43	Pump 2 Interlock	DigIN Slot0.1 *	427	OPEN = Not active CLOSED = Active
P3.5.1.44	Pump 3 Interlock	DigIN Slot0.1 *	428	OPEN = Not active CLOSED = Active
P3.5.1.45	Pump 4 Interlock	DigIN Slot0.1	429	OPEN = Not active CLOSED = Active

Table 43: Digital input settings

Index	Parameter	Default	ID	Description
P3.5.1.46	Pump 5 Interlock	DigIN Slot0.1	430	OPEN = Not active CLOSED = Active
P3.5.1.47	Pump 6 Interlock	DigIN Slot0.1	486	OPEN = Not active CLOSED = Active
P3.5.1.48	Pump 7 Interlock	DigIN Slot0.1	487	OPEN = Not active CLOSED = Active
P3.5.1.49	Pump 8 Interlock	DigIN Slot0.1	488	OPEN = Not active CLOSED = Active
P3.5.1.52	Reset kWh Trip Counter	DigIN Slot0.1	1053	
P3.5.1.53	Parameter Set 1/2 Selection	DigIN Slot0.1	496	OPEN = Parameter Set 1 CLOSED = Parameter Set 2
P3.5.1.54	Multi-Setpoint Selection 0	DigIN Slot0.1	15576	
P3.5.1.55	Multi-Setpoint Selection 1	DigIN Slot0.1	15577	
P3.5.1.56	Multi-Setpoint Selection 2	DigIN Slot0.1	15578	
P3.5.1.57	Multi-Setpoint Selection 3	DigIN Slot0.1	15579	
P3.5.1.58	Flow Switch	DigIN Slot0.2	15590	
P3.5.1.59	AHF Over Temperature	DigIN Slot0.1	15513	

* = The selection of the application with parameter P1.2 Application gives the default value. See the default values in *12.1 The default values of parameters in the different applications.*

**NOTE!**

Your option board and board setup gives the number of available analogue inputs. The standard I/O board has 2 analogue inputs.

Table 44: Analogue input 1 settings

Index	Parameter	Min	Max	Unit	Default	ID	Description
P3.5.2.1.1	AI1 Signal Selection				AnIN SlotA.1 *	377	
P3.5.2.1.2	AI1 Signal Filter Time	0.00	300.00	s	0.1 *	378	
P3.5.2.1.3	AI1 Signal Range	0	1		0 *	379	0 = 0...10V / 0...20mA 1 = 2...10V / 4...20mA
P3.5.2.1.4	AI1 Custom. Min	-160.00	160.00	%	0.00 *	380	
P3.5.2.1.5	AI1 Custom. Max	-160.00	160.00	%	100.00 *	381	
P3.5.2.1.6	AI1 Signal Inversion	0	1		0 *	387	0 = Normal 1 = Signal inverted

* = The selection of the application with parameter P1.2 Application gives the default value. See the default values in 12.1 *The default values of parameters in the different applications.*

Table 45: Analogue input 2 settings

Index	Parameter	Min	Max	Unit	Default	ID	Description
P3.5.2.2.1	AI2 Signal Selection				AnIN SlotA.2 *	388	See P3.5.2.1.1.
P3.5.2.2.2	AI2 Signal Filter Time	0.00	300.00	s	0.1 *	389	See P3.5.2.1.2.
P3.5.2.2.3	AI2 Signal Range	0	1		1 *	390	See P3.5.2.1.3.
P3.5.2.2.4	AI2 Custom. Min	-160.00	160.00	%	0.00 *	391	See P3.5.2.1.4.
P3.5.2.2.5	AI2 Custom. Max	-160.00	160.00	%	100.00 *	392	See P3.5.2.1.5.
P3.5.2.2.6	AI2 Signal Inversion	0	1		0 *	398	See P3.5.2.1.6.

* = The selection of the application with parameter P1.2 Application gives the default value. See the default values in 12.1 *The default values of parameters in the different applications.*

Table 46: Analogue input 3 settings

Index	Parameter	Min	Max	Unit	Default	ID	Description
P3.5.2.3.1	AI3 Signal Selection				AnIN SlotD.1	141	See P3.5.2.1.1.
P3.5.2.3.2	AI3 Signal Filter Time	0.00	300.00	s	0.1	142	See P3.5.2.1.2.
P3.5.2.3.3	AI3 Signal Range	0	1		0	143	See P3.5.2.1.3.
P3.5.2.3.4	AI3 Custom. Min	-160.00	160.00	%	0.00	144	See P3.5.2.1.4.
P3.5.2.3.5	AI3 Custom. Max	-160.00	160.00	%	100.00	145	See P3.5.2.1.5.
P3.5.2.3.6	AI3 Signal Inversion	0	1		0	151	See P3.5.2.1.6.

Table 47: Analogue input 4 settings

Index	Parameter	Min	Max	Unit	Default	ID	Description
P3.5.2.4.1	AI4 Signal Selection				AnIN SlotD.2	152	See P3.5.2.1.1.
P3.5.2.4.2	AI4 Signal Filter Time	0.00	300.00	s	0.1	153	See P3.5.2.1.2.
P3.5.2.4.3	AI4 Signal Range	0	1		0	154	See P3.5.2.1.3.
P3.5.2.4.4	AI4 Custom. Min	-160.00	160.00	%	0.00	155	See P3.5.2.1.4.
P3.5.2.4.5	AI4 Custom. Max	-160.00	160.00	%	100.00	156	See P3.5.2.1.5.
P3.5.2.4.6	AI4 Signal Inversion	0	1		0	162	See P3.5.2.1.6.

Table 48: Analogue input 5 settings

Index	Parameter	Min	Max	Unit	Default	ID	Description
P3.5.2.5.1	AI5 Signal Selection				AnIN SlotE.1	188	See P3.5.2.1.1.
P3.5.2.5.2	AI5 Signal Filter Time	0.00	300.00	s	0.1	189	See P3.5.2.1.2.
P3.5.2.5.3	AI5 Signal Range	0	1		0	190	See P3.5.2.1.3.
P3.5.2.5.4	AI5 Custom. Min	-160.00	160.00	%	0.00	191	See P3.5.2.1.4.
P3.5.2.5.5	AI5 Custom. Max	-160.00	160.00	%	100.00	192	See P3.5.2.1.5.
P3.5.2.5.6	AI5 Signal Inversion	0	1		0	198	See P3.5.2.1.6.

Table 49: Analogue input 6 settings

Index	Parameter	Min	Max	Unit	Default	ID	Description
P3.5.2.6.1	AI6 Signal Selection				AnIN SlotE.2	199	See P3.5.2.1.1.
P3.5.2.6.2	AI6 Signal Filter Time	0.00	300.00	s	0.1	200	See P3.5.2.1.2.
P3.5.2.6.3	AI6 Signal Range	0	1		0	201	See P3.5.2.1.3.
P3.5.2.6.4	AI6 Custom. Min	-160.00	160.00	%	0.00	202	See P3.5.2.1.4.
P3.5.2.6.5	AI6 Custom. Max	-160.00	160.00	%	100.00	203	See P3.5.2.1.5.
P3.5.2.6.6	AI6 Signal Inversion	0	1		0	209	See P3.5.2.1.6.

Table 50: Digital output settings on standard I/O board, Slot B

Index	Parameter	Min	Max	Unit	Default	ID	Description
P3.5.3.2.1	R01 Function	0	74		Varies	11001	The function selection for R01: 0 = None 1 = Ready 2 = Run 3 = General fault 4 = General fault inverted 5 = General alarm 6 = Reversed 7 = At speed 8 = Thermistor fault 9 = Motor regulator active 10 = Start signal active 11 = Keypad control active 12 = I/O B control activated 13 = Limit supervision 1 14 = Limit supervision 2 15 = Fire Mode active 16 = Flushing activated 17 = Preset freq. active 18 = Quick stop activated 19 = PID in Sleep mode 20 = PID soft fill active 21 = PID feedback supervision (limits) 22 = Ext. PID supervision (limits) 23 = Input press. alarm/fault 24 = Frost prot. alarm/fault 25 = Time channel 1

Table 50: Digital output settings on standard I/O board, Slot B

Index	Parameter	Min	Max	Unit	Default	ID	Description
P3.5.3.2.1	R01 Function	0	74		Varies	11001	26 = Time channel 2 27 = Time channel 3 28 = FB ControlWord B13 29 = FB ControlWord B14 30 = FB ControlWord B15 31 = FB Process-Data1.B0 32 = FB Process-Data1.B1 33 = FB Process-Data1.B2 34 = Maintenance alarm 35 = Maintenance fault 36 = Block 1 Out 37 = Block 2 Out 38 = Block 3 Out 39 = Block 4 Out 40 = Block 5 Out 41 = Block 6 Out 42 = Block 7 Out 43 = Block 8 Out 44 = Block 9 Out 45 = Block 10 Out 46 = Jockey pump control 47 = Priming pump control 48 = Auto-cleaning active 49 = Multi-pump K1 control 50 = Multi-pump K2 control 51 = Multi-pump K3 control 52 = Multi-pump K4 control 53 = Multi-pump K5 control 54 = Multi-pump K6 control

Table 50: Digital output settings on standard I/O board, Slot B

Index	Parameter	Min	Max	Unit	Default	ID	Description
P3.5.3.2.1	R01 Function	0	74		Varies	11001	55 = Multi-pump K7 control 56 = Multi-pump K8 control 69 = Selected parameter set 72 = AHF Cap Disconnect 73 = AHF Cap Disconnect Inv 74 = Run indication
P3.5.3.2.2	R01 ON Delay	0.00	320.00	s	0.00	11002	
P3.5.3.2.3	R01 OFF Delay	0.00	320.00	s	0.00	11003	
P3.5.3.2.4	R02 Function	0	56		Varies	11004	See P3.5.3.2.1.
P3.5.3.2.5	R02 ON Delay	0.00	320.00	s	0.00	11005	See M3.5.3.2.2.
P3.5.3.2.6	R02 OFF Delay	0.00	320.00	s	0.00	11006	See M3.5.3.2.3.
P3.5.3.2.7	R03 Function	0	56		Varies	11007	See P3.5.3.2.1. Shows if more than 2 output relays are installed.

* = The selection of the application with parameter P1.2 Application gives the default value. See the default values in *12.1 The default values of parameters in the different applications.*

THE DIGITAL OUTPUTS OF THE EXPANDER SLOTS C, D AND E

Shows only the parameters for the outputs on option boards in slots C, D and E. Make the selections as in R01 Function (P3.5.3.2.1).

This group or these parameters do not show, if there are no digital outputs in slots C, D or E.

Table 51: Standard I/O board analogue output settings, Slot A

Index	Parameter	Min	Max	Unit	Default	ID	Description
P3.5.4.1.1	A01 function	0	31		2 *	10050	0 = TEST 0% (Not used) 1 = TEST 100% 2 = Output freq (0 - fmax) 3 = Freq reference (0 - fmax) 4 = Motor speed (0 - Motor nominal speed) 5 = Output current (0 - I _n Motor) 6 = Motor torque (0 - T _n Motor) 7 = Motor power (0 - P _n Motor) 8 = Motor voltage (0 - U _n Motor) 9 = DC link voltage (0 - 1000V) 10 = PID Setpoint (0-100%) 11 = PID Feedback (0-100%) 12 = PID1 output (0-100%) 13 = Ext.PID output (0-100%) 14 = ProcessDataIn1 (0-100%) 15 = ProcessDataIn2 (0-100%) 16 = ProcessDataIn3 (0-100%)

Table 51: Standard I/O board analogue output settings, Slot A

Index	Parameter	Min	Max	Unit	Default	ID	Description
P3.5.4.1.1	A01 function	0	31		2 *	10050	17 = ProcessDataIn4 (0-100%) 18 = ProcessDataIn5 (0-100%) 19 = ProcessDataIn6 (0-100%) 20 = ProcessDataIn7 (0-100%) 21 = ProcessDataIn8 (0-100%) 22 = Block Out.1 (0-100%) 23 = Block Out.2 (0-100%) 24 = Block Out.3 (0-100%) 25 = Block Out.4 (0-100%) 26 = Block Out.5 (0-100%) 27 = Block Out.6 (0-100%) 28 = Block Out.7 (0-100%) 29 = Block Out.8 (0-100%) 30 = Block Out.9 (0-100%) 31 = Block Out.10 (0-100%)
P3.5.4.1.2	A01 filter time	0.0	300.0	s	1.0 *	10051	0 = No filtering
P3.5.4.1.3	A01 minimum	0	1		0 *	10052	0 = 0 mA / 0V 1 = 4 mA / 2V
P3.5.4.1.4	A01 minimum scale	-214748.36	214748.36	Varies	0.0 *	10053	
P3.5.4.1.5	A01 maximum scale	-214748.36	214748.36	Varies	0.0 *	10054	

* = The selection of the application with parameter P1.2 Application gives the default value. See the default values in *12.1 The default values of parameters in the different applications.*

THE ANALOGUE OUTPUTS OF THE EXPANDER SLOTS C, D AND E

Shows only the parameters for the outputs on option boards in slots C, D and E. Make the selections as in A01 Function (P3.5.4.1.1).

This group or these parameters do not show, if there are no digital outputs in slots C, D or E.

5.6 GROUP 3.6: FIELDBUS DATA MAPPING

Table 52: Fieldbus data mapping

Index	Parameter	Min	Max	Unit	Default	ID	Description
P3.6.1	Fieldbus Data Out 1 Selection	0	35000		1	852	
P3.6.2	Fieldbus Data Out 2 Selection	0	35000		2	853	
P3.6.3	Fieldbus Data Out 3 Selection	0	35000		3	854	
P3.6.4	Fieldbus Data Out 4 Selection	0	35000		4	855	
P3.6.5	Fieldbus Data Out 5 Selection	0	35000		5	856	
P3.6.6	Fieldbus Data Out 6 Selection	0	35000		6	857	
P3.6.7	Fieldbus Data Out 7 Selection	0	35000		7	858	
P3.6.8	Fieldbus Data Out 8 Selection	0	35000		37	859	

Table 53: The default values for Process Data Out in fieldbus

Data	Default value	Scale
Process Data Out 1	Output frequency	0.01 Hz
Process Data Out 2	Motor speed	1 rpm
Process Data Out 3	Motor current	0.1 A
Process Data Out 4	Motor torque	0.1%
Process Data Out 5	Motor power	0.1%
Process Data Out 6	Motor voltage	0.1 V
Process Data Out 7	DC link voltage	1 V
Process Data Out 8	Last active fault code	1

For example, the value *2500* for Output frequency equals 25.00 Hz, because the scale is 0.01. All the monitoring values that you can find in Chapter 4.1 *Monitor group* are given the scale value.

5.7 GROUP 3.7: PROHIBIT FREQUENCIES

Table 54: Prohibit frequencies

Index	Parameter	Min	Max	Unit	Default	ID	Description
P3.7.1	Prohibit Frequency Range 1 Low Limit	-1.00	320.00	Hz	0.00	509	0 = Not used
P3.7.2	Prohibit Frequency Range 1 High Limit	0.00	320.00	Hz	0.00	510	0 = Not used
P3.7.3	Prohibit Frequency Range 2 Low Limit	0.00	320.00	Hz	0.00	511	0 = Not used
P3.7.4	Prohibit Frequency Range 2 High Limit	0.00	320.00	Hz	0.00	512	0 = Not used
P3.7.5	Prohibit Frequency Range 3 Low Limit	0.00	320.00	Hz	0.00	513	0 = Not used
P3.7.6	Prohibit Frequency Range 3 High Limit	0.00	320.00	Hz	0.00	514	0 = Not used
P3.7.7	Ramp Time Factor	0.1	10.0	Times	1.0	518	

5.8 GROUP 3.8: SUPERVISIONS

Table 55: Supervision settings

Index	Parameter	Min	Max	Unit	Default	ID	Description
P3.8.1	Supervision #1 Item Selection	0	17		0	1431	0 = Output frequency 1 = Frequency reference 2 = Motor current 3 = Motor torque 4 = Motor power 5 = DC-link voltage 6 = Analogue input 1 7 = Analogue input 2 8 = Analogue input 3 9 = Analogue input 4 10 = Analogue input 5 11 = Analogue input 6 12 = Temperature input 1 13 = Temperature input 2 14 = Temperature input 3 15 = Temperature input 4 16 = Temperature input 5 17 = Temperature input 6
P3.8.2	Supervision #1 Mode	0	2		0	1432	0 = Not used 1 = Low limit supervision 2 = High limit supervision
P3.8.3	Supervision #1 Limit	-50.00	50.00	Varies	25.00	1433	
P3.8.4	Supervision #1 Limit Hysteresis	0.00	50.00	Varies	5.00	1434	
P3.8.5	Supervision #2 Item Selection	0	17		1	1435	See P3.8.1
P3.8.6	Supervision #2 Mode	0	2		0	1436	See P3.8.2
P3.8.7	Supervision #2 Limit	-50.00	50.00	Varies	40.00	1437	
P3.8.8	Supervision #2 Limit Hysteresis	0.00	50.00	Varies	5.00	1438	

5.9 GROUP 3.9: PROTECTIONS

Table 56: General protections settings

Index	Parameter	Min	Max	Unit	Default	ID	Description
P3.9.1.2	Response to External Fault	0	3		2	701	0 = No action 1 = Alarm 2 = Fault (Stop according to stop function) 3 = Fault (Stop by coasting)
P3.9.1.3	Input Phase Fault	0	1		0	730	0 = 3-phase support 1 = 1-phase support
P3.9.1.4	Undervoltage Fault	0	1		0	727	0 = Fault stored in history 1 = Fault not stored in history
P3.9.1.5	Response to Output Phase Fault	0	3		2	702	
P3.9.1.6	Response to Field-bus Communication Fault	0	4		3	733	0 = No action 1 = Alarm 2 = Alarm + preset fault frequency (P3.9.1.13) 3 = Fault (Stop according to stop function) 4 = Fault (Stop by coasting)
P3.9.1.7	Slot Communication Fault	0	3		2	734	
P3.9.1.8	Thermistor Fault	0	3		0	732	
P3.9.1.9	PID Soft Fill Fault	0	3		2	748	
P3.9.1.10	Response to PID Supervision Fault	0	3		2	749	
P3.9.1.11	Response to External PID Supervision Fault	0	3		2	757	
P3.9.1.13	Preset Alarm Frequency	P3.3.1.1	P3.3.1.2	Hz	25.00	183	
P3.9.1.14	Response to Safe Torque Off (STO) Fault	0	2		2	775	0 = No action 1 = Alarm 2 = Fault (Stop by coasting)

Table 57: Motor thermal protection settings

Index	Parameter	Min	Max	Unit	Default	ID	Description
P3.9.2.1	Motor Thermal Protection	0	3		2	704	0 = No action 1 = Alarm 2 = Fault (Stop by stop mode) 3 = Fault (Stop by coasting)
P3.9.2.2	Ambient Temperature	-20.0	100.0	°C	40.0	705	
P3.9.2.3	Zero Speed Cooling Factor	5.0	100.0	%	Varies	706	
P3.9.2.4	Motor Thermal Time Constant	1	200	min	Varies	707	
P3.9.2.5	Motor Thermal Loadability	10	150	%	100	708	

Table 58: Motor stall protection settings

Index	Parameter	Min	Max	Unit	Default	ID	Description
P3.9.3.1	Motor Stall Fault	0	3		0	709	0 = No action 1 = Alarm 2 = Fault (Stop according to stop mode) 3 = Fault (Stop by coasting)
P3.9.3.2	Stall Current	0.00	5.2	A	3.7	710	
P3.9.3.3	Stall Time Limit	1.00	120.00	s	15.00	711	
P3.9.3.4	Stall Frequency Limit	1.00	P3.3.1.2	Hz	25.00	712	

Table 59: Motor underload protection settings

Index	Parameter	Min	Max	Unit	Default	ID	Description
P3.9.4.1	Underload Fault	0	3		0	713	0 = No action 1 = Alarm 2 = Fault (Stop according to stop mode) 3 = Fault (Stop by coasting)
P3.9.4.2	Underload Protection: Field Weakening Area Load	10.0	150.0	%	50.0	714	
P3.9.4.3	Underload Protection: Zero Frequency Load	5.0	150.0	%	10.0	715	
P3.9.4.4	Underload Protection: Time Limit	2.00	200.00	s	20.00	716	

Table 60: Quick stop settings

Index	Parameter	Min	Max	Unit	Default	ID	Description
P3.9.5.1	Quick Stop Mode	0	2		Varies	1276	0 = Coasting 1 = Quick stop deceleration time 2 = Stop according to Stop function (P3.2.5)
P3.9.5.2	Quick Stop Activation	Varies	Varies		DigIN Slot0.2	1213	OPEN = Activated
P3.9.5.3	Quick Stop Deceleration Time	0.1	300.0	s	Varies	1256	
P3.9.5.4	Response to Quick Stop Fault	0	2		Varies	744	0 = No action 1 = Alarm 2 = Fault (Stop according to Quick stop mode)

Table 61: Temperature input fault 1 settings

Index	Parameter	Min	Max	Unit	Default	ID	Description
P3.9.6.1	Temperature Signal 1	0	63		0	739	B0 = Temperature Signal 1 B1 = Temperature Signal 2 B2 = Temperature Signal 3 B3 = Temperature Signal 4 B4 = Temperature Signal 5 B5 = Temperature Signal 6
P3.9.6.2	Alarm Limit 1	-30.0	200.0	°C	130.0	741	
P3.9.6.3	Fault Limit 1	-30.0	200.0	°C	155.0	742	
P3.9.6.4	Fault Limit Response 1	0	3		2	740	0 = No response 1 = Alarm 2 = Fault (Stop according to stop mode) 3 = Fault (Stop by coasting)

**NOTE!**

Temperature input settings are only available if a B8 or BH option board is installed.

Table 62: Temperature input fault 2 settings

Index	Parameter	Min	Max	Unit	Default	ID	Description
P3.9.6.5	Temperature Signal 2	0	63		0	763	B0 = Temperature Signal 1 B1 = Temperature Signal 2 B2 = Temperature Signal 3 B3 = Temperature Signal 4 B4 = Temperature Signal 5 B5 = Temperature Signal 6
P3.9.6.6	Alarm Limit 2	-30.0	200.0	°C	130.0	764	
P3.9.6.7	Fault Limit 2	-30.0	200.0	°C	155.0	765	
P3.9.6.8	Fault Limit Response 2	0	3		2	766	0 = No response 1 = Alarm 2 = Fault (Stop according to stop mode) 3 = Fault (Stop by coasting)

**NOTE!**

Temperature input settings are only available if a B8 or BH option board is installed.

Table 63: AI low protection settings

Index	Parameter	Min	Max	Unit	Default	ID	Description
P3.9.8.1	Analogue Input Low Protection	0	2			767	0 = No protection 1 = Protection enabled in Run state 2 = Protection enabled in Run and Stop state
P3.9.8.2	Analogue Input Low Fault	0	5		0	700	0 = No action 1 = Alarm 2 = Alarm + preset fault frequency (P3.9.1.13) 3 = Alarm + previous frequency reference 4 = Fault (Stop according to stop mode) 5 = Fault (Stop by coasting)

5.10 GROUP 3.10: AUTOMATIC RESET

Table 64: Autoreset settings

Index	Parameter	Min	Max	Unit	Default	ID	Description
P3.10.1	Automatic Reset	0	1		0 *	731	0 = Disabled 1 = Enabled
P3.10.2	Restart Function	0	1		1	719	0 = Flying start 1 = According to P3.2.4.
P3.10.3	Wait Time	0.10	10000.0 0	s	0.50	717	
P3.10.4	Trial Time	0.00	10000.0 0	s	60.00	718	
P3.10.5	Number of Trials	1	10		4	759	
P3.10.6	Autoreset: Under-voltage	0	1		1	720	0 = No 1 = Yes
P3.10.7	Autoreset: Overvoltage	0	1		1	721	0 = No 1 = Yes
P3.10.8	Autoreset: Overcurrent	0	1		1	722	0 = No 1 = Yes
P3.10.9	Autoreset: AI Low	0	1		1	723	0 = No 1 = Yes
P3.10.10	Autoreset: Unit Over-temperature	0	1		1	724	0 = No 1 = Yes
P3.10.11	Autoreset: Motor Overtemperature	0	1		1	725	0 = No 1 = Yes
P3.10.12	Autoreset: External Fault	0	1		0	726	0 = No 1 = Yes
P3.10.13	Autoreset: Under-load Fault	0	1		0	738	0 = No 1 = Yes
P3.10.14	Autoreset: PID Supervision Fault	0	1		0	776	0 = No 1 = Yes
P3.10.15	Autoreset: Ext PID Supervision Fault	0	1		0	777	0 = No 1 = Yes

* The selection of the application with parameter P1.2 Application gives the default value. See the default values in *12.1 The default values of parameters in the different applications.*

5.11 GROUP 3.11: APPLICATION SETTINGS

Table 65: Application settings

Index	Parameter	Min	Max	Unit	Default	ID	Description
P3.11.1	Password	0	9999		0	1806	
P3.11.2	C/F Selection	0	1		0 *	1197	0 = Celsius 1 = Fahrenheit
P3.11.3	kW/hp Selection	0	1		0	1198	0 = kW 1 = hp
P3.11.4	Multimonitor View	0	2		1	1196	0 = 2x2 sections 1 = 3x2 sections 2 = 3x3 sections

5.12 GROUP 3.12: TIMER FUNCTIONS

Table 66: Interval 1

Index	Parameter	Min	Max	Unit	Default	ID	Description
P3.12.1.1	ON Time	00:00:00	23:59:59	hh:mm:ss	00:00:00	1464	
P3.12.1.2	OFF Time	00:00:00	23:59:59	hh:mm:ss	00:00:00	1465	
P3.12.1.3	Days					1466	B0 = Sunday B1 = Monday B2 = Tuesday B3 = Wednesday B4 = Thursday B5 = Friday B6 = Saturday
P3.12.1.4	Assign to Channel					1468	B0 = Time channel 1 B1 = Time channel 2 B2 = Time channel 3

Table 67: Interval 2

Index	Parameter	Min	Max	Unit	Default	ID	Description
P3.12.2.1	ON Time	00:00:00	23:59:59	hh:mm:ss	00:00:00	1469	See Interval 1.
P3.12.2.2	OFF Time	00:00:00	23:59:59	hh:mm:ss	00:00:00	1470	See Interval 1.
P3.12.2.3	Days					1471	See Interval 1.
P3.12.2.4	Assign to Channel					1473	See Interval 1.

Table 68: Interval 3

Index	Parameter	Min	Max	Unit	Default	ID	Description
P3.12.3.1	ON Time	00:00:00	23:59:59	hh:mm:ss	00:00:00	1474	See Interval 1.
P3.12.3.2	OFF Time	00:00:00	23:59:59	hh:mm:ss	00:00:00	1475	See Interval 1.
P3.12.3.3	Days					1476	See Interval 1.
P3.12.3.4	Assign to Channel					1478	See Interval 1.

Table 69: Interval 4

Index	Parameter	Min	Max	Unit	Default	ID	Description
P3.12.4.1	ON Time	00:00:00	23:59:59	hh:mm:ss	00:00:00	1479	See Interval 1.
P3.12.4.2	OFF Time	00:00:00	23:59:59	hh:mm:ss	00:00:00	1480	See Interval 1.
P3.12.4.3	Days					1481	See Interval 1.
P3.12.4.4	Assign to Channel					1483	See Interval 1.

Table 70: Interval 5

Index	Parameter	Min	Max	Unit	Default	ID	Description
P3.12.5.1	ON Time	00:00:00	23:59:59	hh:mm:ss	00:00:00	1484	See Interval 1.
P3.12.5.2	OFF Time	00:00:00	23:59:59	hh:mm:ss	00:00:00	1485	See Interval 1.
P3.12.5.3	Days					1486	See Interval 1.
P3.12.5.4	Assign to Channel					1488	See Interval 1.

Table 71: Timer 1

Index	Parameter	Min	Max	Unit	Default	ID	Description
P3.12.6.1	Duration	0	72000	s	0	1489	
P3.12.6.2	Timer 1				DigINSlot 0.1	447	
P3.12.6.3	Assign to Channel					1490	B0 = Time channel 1 B1 = Time channel 2 B2 = Time channel 3

Table 72: Timer 2

Index	Parameter	Min	Max	Unit	Default	ID	Description
P3.12.7.1	Duration	0	72000	s	0	1491	See Timer 1.
P3.12.7.2	Timer 2				DigINSlot 0.1	448	See Timer 1.
P3.12.7.3	Assign to Channel					1492	See Timer 1.

Table 73: Timer 3

Index	Parameter	Min	Max	Unit	Default	ID	Description
P3.12.8.1	Duration	0	72000	s	0	1493	See Timer 1.
P3.12.8.2	Timer 3				DigINSlot 0.1	449	See Timer 1.
P3.12.8.3	Assign to Channel					1494	See Timer 1.

5.13 GROUP 3.13: PID CONTROLLER

Table 74: PID controller 1 basic settings

Index	Parameter	Min	Max	Unit	Default	ID	Description
P3.13.1.1	PID Gain	0.00	1000.00	%	100.00	118	
P3.13.1.2	PID Integration Time	0.00	600.00	s	1.00	119	
P3.13.1.3	PID Derivation Time	0.00	100.00	s	0.00	132	
P3.13.1.4	Process Unit Selection	1	46		1	1036	1 = % 2 = 1/min 3 = rpm 4 = ppm 5 = pps 6 = l/s 7 = l/min 8 = l/h 9 = kg/s 10 = kg/min 11 = kg/h 12 = m ³ /s 13 = m ³ /min 14 = m ³ /h 15 = m/s 16 = mbar 17 = bar 18 = Pa 19 = kPa 20 = mVS 21 = kW 22 = °C 23 = gal/s 24 = gal/min 25 = gal/h 26 = lb/s 27 = lb/min 28 = lb/h 29 = ft ³ /s 30 = ft ³ /min 31 = ft ³ /h 32 = ft/s 33 = in wg 34 = ft wg 35 = SPI 36 = lb/in ² 37 = psig 38 = hp 39 = °F 40 = ft 41 = inch 42 = mm 43 = cm 44 = m 45 = gpm 46 = cfm

Table 74: PID controller 1 basic settings

Index	Parameter	Min	Max	Unit	Default	ID	Description
P3.13.1.5	Process Unit Min	Varies	Varies	Varies	0	1033	
P3.13.1.6	Process Unit Max	Varies	Varies	Varies	100	1034	
P3.13.1.7	Process Unit Decimals	0	4		2	1035	
P3.13.1.8	Error Inversion	0	1		0	340	0 = Normal (Feedback < Setpoint -> Increase PID output) 1 = Inverted (Feedback < Setpoint -> Decrease PID output)
P3.13.1.9	Dead Band	0.00	99999.9 9	Varies	0	1056	
P3.13.1.10	Dead Band Delay	0.00	320.00	s	0.00	1057	

Table 75: Setpoint settings

Index	Parameter	Min	Max	Unit	Default	ID	Description
P3.13.2.1	Keypad Setpoint 1	P3.13.1.5	P3.13.1.6	P3.13.1.4	0	167	
P3.13.2.2	Keypad Setpoint 2	P3.13.1.5	P3.13.1.6	P3.13.1.4	0	168	
P3.13.2.3	Setpoint Ramp Time	0.00	300.0	s	0.00	1068	
P3.13.2.4	PID Setpoint Boost Activation	Varies	Varies		DigIN Slot0.1	1046	OPEN = No boost CLOSED = Boost
P3.13.2.5	PID Setpoint Selection	Varies	Varies		DigIN Slot0.1 *	1047	OPEN = Setpoint 1 CLOSED = Setpoint 2
P3.13.2.6	Setpoint Source 1 Selection	0	33		3 *	332	0 = Not used 1 = Keypad setpoint 1 2 = Keypad setpoint 2 3 = AI1 4 = AI2 5 = AI3 6 = AI4 7 = AI5 8 = AI6 9 = ProcessDataIn1 10 = ProcessDataIn2 11 = ProcessDataIn3 12 = ProcessDataIn4 13 = ProcessDataIn5 14 = ProcessDataIn6 15 = ProcessDataIn7 16 = ProcessDataIn8 17 = Temperature input 1 18 = Temperature input 2 19 = Temperature input 3 20 = Temperature input 4 21 = Temperature input 5 22 = Temperature input 6 23 = Block Out.1 24 = Block Out.2 25 = Block Out.3 26 = Block Out.4 27 = Block Out.5 28 = Block Out.6 29 = Block Out.7 30 = Block Out.8 31 = Block Out.9 32 = Block Out.10 33 = Multi-setpoint

Table 75: Setpoint settings

Index	Parameter	Min	Max	Unit	Default	ID	Description
P3.13.2.7	Setpoint 1 Minimum	-200.00	200.00	%	0.00	1069	
P3.13.2.8	Setpoint 1 Maximum	-200.00	200.00	%	100.00	1070	
P3.13.2.9	Setpoint 1 Boost	-2.0	2.0	x	1.0	1071	
P3.13.2.10	Setpoint Source 2 Selection	0	Varies		2 *	431	See P3.13.2.6.
P3.13.2.11	Setpoint 2 Minimum	-200.00	200.00	%	0.00	1073	See P3.13.2.7.
P3.13.2.12	Setpoint 2 Maximum	-200.00	200.00	%	100.00	1074	See P3.13.2.8.
P3.13.2.13	Setpoint 2 Boost	-2.0	2.0	x	1.0	1078	See P3.13.2.9.

* = The selection of the application with parameter P1.2 Application gives the default value. See the default values in *12.1 The default values of parameters in the different applications.*

Table 76: Feedback settings

Index	Parameter	Min	Max	Unit	Default	ID	Description
P3.13.3.1	Feedback Function	1	9		1 *	333	1 = Only Source1 in use 2 = SQRT(Source1); (Flow=Constant x SQRT(Pressure)) 3 = SQRT(Source1-Source 2) 4 = SQRT(Source 1) + SQRT (Source 2) 5 = Source 1 + Source 2 6 = Source 1 - Source 2 7 = MIN (Source 1, Source 2) 8 = MAX (Source 1, Source 2) 9 = MEAN (Source 1, Source 2)
P3.13.3.2	Feedback Function Gain	-1000.0	1000.0	%	100.0	1058	
P3.13.3.3	Feedback 1 Source Selection	0	30		2 *	334	0 = Not used 1 = AI1 2 = AI2 3 = AI3 4 = AI4 5 = AI5 6 = AI6 7 = ProcessDataIn1 8 = ProcessDataIn2 9 = ProcessDataIn3 10 = ProcessDataIn4 11 = ProcessDataIn5 12 = ProcessDataIn6 13 = ProcessDataIn7 14 = ProcessDataIn8 15 = Temperature input 1 16 = Temperature input 2 17 = Temperature input 3 18 = Temperature input 4 19 = Temperature input 5 20 = Temperature input 6 21 = Block Out.1 22 = Block Out.2 23 = Block Out.3 24 = Block Out.4 25 = Block Out.5 26 = Block Out.6 27 = Block Out.7 28 = Block Out.8 29 = Block Out.9 30 = Block Out.10
P3.13.3.4	Feedback 1 Minimum	-200.00	200.00	%	0.00	336	

Table 76: Feedback settings

Index	Parameter	Min	Max	Unit	Default	ID	Description
P3.13.3.5	Feedback 1 Maximum	-200.00	200.00	%	100.00	337	
P3.13.3.6	Feedback 2 Source Selection	0	30		0	335	See P3.13.3.3.
P3.13.3.7	Feedback 2 Minimum	-200.00	200.00	%	0.00	338	See P3.13.3.4.
M3.13.3.8	Feedback 2 Maximum	-200.00	200.00	%	100.00	339	See P3.13.3.5.

* = The selection of the application with parameter P1.2 Application gives the default value. See the default values in 12.1 *The default values of parameters in the different applications.*

Table 77: Feedforward settings

Index	Parameter	Min	Max	Unit	Default	ID	Description
P3.13.4.1	Feedforward Function	1	9		1	1059	See P3.13.3.1
P3.13.4.2	Feedforward Function Gain	-1000	1000	%	100.0	1060	See P3.13.3.2
P3.13.4.3	Feedforward 1 Source Selection	0	30		0	1061	See P3.13.3.3
P3.13.4.4	Feedforward 1 Minimum	-200.00	200.00	%	0.00	1062	See P3.13.3.4
P3.13.4.5	Feedforward 1 Maximum	-200.00	200.00	%	100.00	1063	See P3.13.3.5
P3.13.4.6	Feedforward 2 Source Selection	0	30		0	1064	See P3.13.3.3
P3.13.4.7	Feedforward 2 Min	-200.00	200.00	%	0.00	1065	See P3.13.3.7
P3.13.4.8	Feedforward 2 Max	-200.00	200.00	%	100.00	1066	See M3.13.3.8

Table 78: Sleep function settings

Index	Parameter	Min	Max	Unit	Default	ID	Description
P3.13.5.1	SP1 Sleep Frequency Limit	0.00	320.00	Hz	0.00	1016	0 = Not used
P3.13.5.2	SP1 Sleep Delay	0	3000	s	0	1017	0 = Not used
P3.13.5.3	SP1 Wake Up Level	-214748.36	214748.36	Varies	0.0000	1018	0 = Not used
P3.13.5.4	SP1 Wake Up Mode	0	1		0	1019	0 = Absolute Level 1 = Relative Setpoint
P3.13.5.5	SP1 Sleep Boost	-99999.99	99999.99	P3.13.1.4	0	1793	
P3.13.5.6	SP1 Sleep Boost Maximum Time	1	300	s	30	1795	
P3.13.5.7	SP2 Sleep Frequency	0.00	320.00	Hz	0.00	1075	See P3.13.5.1
P3.13.5.8	SP2 Sleep Delay	0	3000	s	0	1076	See P3.13.5.2
P3.13.5.9	SP2 Wake Up Level	-214748.36	214748.36	Varies	0.0	1077	See P3.13.5.3
P3.13.5.10	SP2 Wake Up Mode	0	1		0	1020	0=Absolute Level 1=Relative Setpoint
P3.13.5.11	SP2 Sleep Boost	-99999.99	99999.99	P3.13.1.4	0	1794	See P3.13.5.5
P3.13.5.12	SP2 Sleep Boost Maximum Time	1	300	s	30	1796	See P3.13.5.6

Table 79: Feedback supervision parameters

Index	Parameter	Min	Max	Unit	Default	ID	Description
P3.13.6.1	Enable Feedback Supervision	0	1		0	735	0 = Disabled 1 = Enabled
P3.13.6.2	Upper Limit	-99999.9 9	99999.9 9	Varies	Varies	736	
P3.13.6.3	Lower Limit	-99999.9 9	99999.9 9	Varies	Varies	758	
P3.13.6.4	Delay	0	30000	s	0	737	
P3.13.6.5	Response to PID Supervision Fault	0	3		2	749	0 = No action 1 = Alarm 2 = Fault (Stop according to stop mode) 3 = Fault (Stop by coasting)

Table 80: Pressure loss compensation parameters

Index	Parameter	Min	Max	Unit	Default	ID	Description
P3.13.7.1	Enable Setpoint 1	0	1		0	1189	0 = Disabled 1 = Enabled
P3.13.7.2	Setpoint 1 Max Compensation	-99999.9 9	99999.9 9	Varies	0.00	1190	
P3.13.7.3	Enable Setpoint 2	0	1		0	1191	See P3.13.7.1.
P3.13.7.4	Setpoint 2 Max Compensation	-99999.9 9	99999.9 9	Varies	0.00	1192	See P3.13.7.2.

Table 81: Soft fill settings

Index	Parameter	Min	Max	Unit	Default	ID	Description
P3.13.8.1	Soft Fill Function	0	2		0	1094	0 = Disabled 1 = Enabled, Level 2 = Enabled, Timeout
P3.13.8.2	Soft Fill Frequency	0.00	P3.3.1.2	Hz	20.00	1055	
P3.13.8.3	Soft Fill Level	-99999.9 9	99999.9 9	Varies	0.0000	1095	
P3.13.8.4	Soft Fill Timeout	0	30000	s	0	1096	0 = No timeout, no fault triggering
P3.13.8.5	Soft Fill Fault	0	3		2	748	0 = No action 1 = Alarm 2 = Fault (Stop according to stop mode) 3 = Fault (Stop by coasting)

Table 82: Input pressure supervision parameters

Index	Parameter	Min	Max	Unit	Default	ID	Description
P3.13.9.1	Enable Supervision	0	1		0	1685	0 = Disabled 1 = Enabled
P3.13.9.2	Supervision Signal	0	23		0	1686	0 = Analogue input 1 1 = Analogue input 2 2 = Analogue input 3 3 = Analogue input 4 4 = Analogue input 5 5 = Analogue input 6 6 = ProcessDataIn1 (0-100%) 7 = ProcessDataIn2 (0-100%) 8 = ProcessDataIn3 (0-100%) 9 = ProcessDataIn4 (0-100%) 10 = ProcessDataIn5 (0-100%) 11 = ProcessDataIn6 (0-100%) 12 = ProcessDataIn7 (0-100%) 13 = ProcessDataIn8 (0-100%) 14 = Block Out.1 15 = Block Out.2 16 = Block Out.3 17 = Block Out.4 18 = Block Out.5 19 = Block Out.6 20 = Block Out.7 21 = Block Out.8 22 = Block Out.9 23 = Block Out.10
P3.13.9.3	Supervision Unit Selection	1	9	Varies	3	1687	1 = % 2 = mbar 3 = bar 4 = Pa 5 = kPa 6 = PSI 7 = mmHg 8 = Torr 9 = lb/in2
P3.13.9.4	Supervision Unit Decimals	0	4		2	1688	
P3.13.9.5	Supervision Unit Minimum Value	-99999.99	99999.99	P3.13.9.3	0.00	1689	

Table 82: Input pressure supervision parameters

Index	Parameter	Min	Max	Unit	Default	ID	Description
P3.13.9.6	Supervision Unit Maximum Value	-99999.99	99999.99	P3.13.9.3	10.00	1690	
P3.13.9.7	Supervision Alarm Level	P3.13.9.5	P3.13.9.6	P3.13.9.3	Varies	1691	
P3.13.9.8	Supervision Fault Level	P3.13.9.5	P3.13.9.7	P3.13.9.3	0.10	1692	
P3.13.9.9	Supervision Fault Delay	0.00	60.00	s	5.00	1693	
P3.13.9.10	PID Setpoint Reduction	0.0	100.0	%	10.0	1694	
V3.13.9.11	Input Pressure	P3.13.9.5	P3.13.9.6	P3.13.9.3	Varies	1695	This monitoring value shows the actual value of the pump input pressure.

Table 83: Sleep - no demand detected

Index	Parameter	Min	Max	Unit	Default	ID	Description
P3.13.10.1	Sleep No Demand Detection Enable	0	1		0	1649	0 = No 1 = Yes
P3.13.10.2	SNDD Error Hysteresis	0	99999.9	P3.13.1.4	0.5	1658	
P3.13.10.3	SNDD Frequency Hysteresis	0.00	P3.3.1.2	Hz	3.00	1663	
P3.13.10.4	SNDD Supervision Time	0	600	s	120	1668	
P3.13.10.5	SNDD Actual Add	0.00	P3.13.10.2	P3.13.1.4	0.5	1669	

Table 84: Multi-setpoint parameters

Index	Parameter	Min	Max	Unit	Default	ID	Description
P3.13.12.1	Multi-Setpoint 0	P3.13.1.5	P3.13.1.6	P3.13.1.4	0.0	15560	
P3.13.12.2	Multi-Setpoint 1	P3.13.1.5	P3.13.1.6	P3.13.1.4	0.0	15561	
P3.13.12.3	Multi-Setpoint 2	P3.13.1.5	P3.13.1.6	P3.13.1.4	0.0	15562	
P3.13.12.4	Multi-Setpoint 3	P3.13.1.5	P3.13.1.6	P3.13.1.4	0.0	15563	
P3.13.12.5	Multi-Setpoint 4	P3.13.1.5	P3.13.1.6	P3.13.1.4	0.0	15564	
P3.13.12.6	Multi-Setpoint 5	P3.13.1.5	P3.13.1.6	P3.13.1.4	0.0	15565	
P3.13.12.7	Multi-Setpoint 6	P3.13.1.5	P3.13.1.6	P3.13.1.4	0.0	15566	
P3.13.12.8	Multi-Setpoint 7	P3.13.1.5	P3.13.1.6	P3.13.1.4	0.0	15567	
P3.13.12.9	Multi-Setpoint 8	P3.13.1.5	P3.13.1.6	P3.13.1.4	0.0	15568	
P3.13.12.10	Multi-Setpoint 9	P3.13.1.5	P3.13.1.6	P3.13.1.4	0.0	15569	
P3.13.12.11	Multi-Setpoint 10	P3.13.1.5	P3.13.1.6	P3.13.1.4	0.0	15570	
P3.13.12.12	Multi-Setpoint 11	P3.13.1.5	P3.13.1.6	P3.13.1.4	0.0	15571	
P3.13.12.13	Multi-Setpoint 12	P3.13.1.5	P3.13.1.6	P3.13.1.4	0.0	15572	
P3.13.12.14	Multi-Setpoint 13	P3.13.1.5	P3.13.1.6	P3.13.1.4	0.0	15573	
P3.13.12.15	Multi-Setpoint 14	P3.13.1.5	P3.13.1.6	P3.13.1.4	0.0	15574	
P3.13.12.16	Multi-Setpoint 15	P3.13.1.5	P3.13.1.6	P3.13.1.4	0.0	15575	
P3.13.12.17	Multi-Setpoint Selection 0				DigIN Slot0.1	15576	
P3.13.12.18	Multi-Setpoint Selection 1				DigIN Slot0.1	15577	

Table 84: Multi-setpoint parameters

Index	Parameter	Min	Max	Unit	Default	ID	Description
P3.13.12.19	Multi-Setpoint Selection 2				DigIN Slot0.1	15578	
P3.13.12.20	Multi-Setpoint Selection 3				DigIN Slot0.1	15579	

5.14 GROUP 3.14: EXTERNAL PID CONTROLLER

Table 85: Basic settings for the external PID controller

Index	Parameter	Min	Max	Unit	Default	ID	Description
P3.14.1.1	Enable External PID	0	1		0	1630	0 = Disabled 1 = Enabled
P3.14.1.2	Start Signal				DigIN Slot0.2	1049	OPEN = PID2 in stop mode CLOSED = PID2 regulating
P3.14.1.3	Output in Stop	0.0	100.0	%	0.0	1100	
P3.14.1.4	PID Gain	0.00	1000.00	%	100.00	1631	See P3.13.1.1
P3.14.1.5	PID Integration Time	0.00	600.00	s	1.00	1632	See P3.13.1.2
P3.14.1.6	PID Derivation Time	0.00	100.00	s	0.00	1633	See P3.13.1.3
P3.14.1.7	Process Unit Selection	0	46		0	1635	See P3.13.1.4
P3.14.1.8	Process Unit Min	Varies	Varies	Varies	0	1664	See P3.13.1.5
P3.14.1.9	Process Unit Max	Varies	Varies	Varies	100	1665	See P3.13.1.6
P3.14.1.10	Process Unit Decimals	0	4		2	1666	See P3.13.1.7
P3.14.1.11	Error Inversion	0	1		0	1636	See P3.13.1.8
P3.14.1.12	Dead Band	0.00	Varies	Varies	0.0	1637	See P3.13.1.9
P3.14.1.13	Dead Band Delay	0.00	320.00	s	0.00	1638	See P3.13.1.10

Table 86: Setpoints of the external PID controller

Index	Parameter	Min	Max	Unit	Default	ID	Description
P3.14.2.1	Keypad Setpoint 1	P3.14.1.8	P3.14.1.9	Varies	0.00	1640	
P3.14.2.2	Keypad Setpoint 2	P3.14.1.8	P3.14.1.9	Varies	0.00	1641	
P3.14.2.3	Setpoint Ramp Time	0.00	300.00	s	0.00	1642	
P3.14.2.4	Setpoint Selection				DigIN Slot0.1	1048	OPEN = Setpoint 1 CLOSED = Setpoint 2
P3.14.2.5	Setpoint Source 1 Selection	0	32		1	1643	0 = Not Used 1 = Keypad Setpoint 1 2 = Keypad Setpoint 2 3 = AI1 4 = AI2 5 = AI3 6 = AI4 7 = AI5 8 = AI6 9 = ProcessDataIn1 10 = ProcessDataIn2 11 = ProcessDataIn3 12 = ProcessDataIn4 13 = ProcessDataIn5 14 = ProcessDataIn6 15 = ProcessDataIn7 16 = ProcessDataIn8 17 = Temperature Input 1 18 = Temperature Input 2 19 = Temperature Input 3 20 = Temperature Input 4 21 = Temperature Input 5 22 = Temperature Input 6 23 = Block Out.1 24 = Block Out.2 25 = Block Out.3 26 = Block Out.4 27 = Block Out.5 28 = Block Out.6 29 = Block Out.7 30 = Block Out.8 31 = Block Out.9 32 = Block Out.10
P3.14.2.6	Setpoint 1 Minimum	-200.00	200.00	%	0.00	1644	
P3.14.2.7	Setpoint 1 Maximum	-200.00	200.00	%	100.00	1645	

Table 86: Setpoints of the external PID controller

Index	Parameter	Min	Max	Unit	Default	ID	Description
P3.14.2.8	Setpoint Source 2 Selection	0	32		2	1646	See P3.14.2.5.
P3.14.2.9	Setpoint 2 Minimum	-200.00	200.00	%	0.00	1647	
P3.14.2.10	Setpoint 2 Maximum	-200.00	200.00	%	100.00	1648	

Table 87: Feedback of the external PID controller

Index	Parameter	Min	Max	Unit	Default	ID	Description
P3.14.3.1	Feedback Function	1	9		1	1650	See P3.13.3.1
P3.14.3.2	Feedback Function Gain	-1000.0	1000.0	%	100.0	1651	See P3.13.3.2
P3.14.3.3	Feedback 1 Source Selection	0	30		2	1652	See P3.13.3.3
P3.14.3.4	Feedback 1 Minimum	-200.00	200.00	%	0.00	1653	
P3.14.3.5	Feedback 1 Maximum	-200.00	200.00	%	100.00	1654	
P3.14.3.6	Feedback 2 Source Selection	0	30		0	1655	See P3.13.3.6.
P3.14.3.7	Feedback 2 Minimum	-200.00	200.00	%	0.00	1656	
P3.14.3.8	Feedback 2 Maximum	-200.00	200.00	%	100.00	1657	

Table 88: Process supervision of the external PID controller

Index	Parameter	Min	Max	Unit	Default	ID	Description
P3.14.4.1	Enable Supervision	0	1		0	1659	0 = Disabled 1 = Enabled
P3.14.4.2	Upper Limit	Varies	Varies	Varies	0	1660	See P3.13.6.2
P3.14.4.3	Lower Limit	Varies	Varies	Varies	0	1661	See P3.13.6.3
P3.14.4.4	Delay	0	30000	s	0	1662	
P3.14.4.5	Response to External PID Supervision Fault	0	3		2	757	See P3.9.1.2

5.15 GROUP 3.15: MULTI-PUMP

Table 89: Multi-pump parameters

Index	Parameter	Min	Max	Unit	Default	ID	Description
P3.15.1	Multi-pump Mode	0	2		0 *	1785	0 = Single Drive 1 = Multifollower 2 = Multimaster
P3.15.2	Number of Pumps	1	8		1 *	1001	
P3.15.3	Pump ID Number	1	8		0	1500	
P3.15.4	Start and Feedback Signals	0	2		1	1782	0 = Not Connected 1 = Only Start Signal Connected 2 = Both Signals Connected
P3.15.5	Pump Interlocking	0	1		1 *	1032	0 = Not used 1 = Enabled
P3.15.6	Autochange	0	2		1 *	1027	0 = Disabled 1 = Enabled (interval) 2 = Enabled (weekdays)
P3.15.7	Autochanged Pumps	0	1		1 *	1028	0 = Auxiliary pumps 1 = All pumps
P3.15.8	Autochange Interval	0.0	3000.0	h	48.0 *	1029	
P3.15.9	Autochange Days	0	127		0	1786	B0 = Sunday B1 = Monday B2 = Tuesday B3 = Wednesday B4 = Thursday B5 = Friday B6 = Saturday
P3.15.10	Autochange: Time of Day	00:00:00	23:59:59	Time	00:00:00	1787	
P3.15.11	Autochange: Frequency Limit	0.00	P3.3.1.2	Hz	25.00 *	1031	
P3.15.12	Autochange: Pump Limit	0	8		1 *	1030	
P3.15.13	Bandwidth	0	100	%	10 *	1097	Setpoint = 5 bar Bandwidth = 10%.
P3.15.14	Bandwidth Delay	0	3600	s	10 *	1098	
P3.15.15	Constant Production Speed	0.0	100.0	%	80.0 *	1513	

Table 89: Multi-pump parameters

Index	Parameter	Min	Max	Unit	Default	ID	Description
P3.15.16	Running Pumps Limit	1	P3.15.2		3 *	1187	
M3.15.17	Interlock Signals	See the interlock signal parameters below.					
M3.15.18	Overpressure Supervision	See the overpressure supervision parameters below.					
M3.15.19	Pump Running Time	See the pump running time counter parameters below.					
M3.15.22	Advanced Settings	See the parameters for advanced settings below.					

* = The selection of the application with parameter P1.2 Application gives the default value. See the default values in 12.1 *The default values of parameters in the different applications.*

Table 90: Interlock signals

Index	Parameter	Min	Max	Unit	Default	ID	Description
P3.15.17.1	Pump 1 interlock	Varies	Varies		DigIN Slot0.1	426	OPEN = Not active CLOSED = Active
P3.15.17.2	Pump 2 interlock	Varies	Varies		DigIN Slot0.1	427	OPEN = Not active CLOSED = Active
P3.15.17.3	Pump 3 interlock	Varies	Varies		DigIN Slot0.1	428	OPEN = Not active CLOSED = Active
P3.15.17.4	Pump 4 interlock	Varies	Varies		DigIN Slot0.1	429	OPEN = Not active CLOSED = Active
P3.15.17.5	Pump 5 interlock	Varies	Varies		DigIN Slot0.1	430	OPEN = Not active CLOSED = Active
P3.15.17.6	Pump 6 interlock	Varies	Varies		DigIN Slot0.1	486	OPEN = Not active CLOSED = Active
P3.15.17.7	Pump 7 interlock	Varies	Varies		DigIN Slot0.1	487	OPEN = Not active CLOSED = Active
P3.15.17.8	Pump 8 interlock	Varies	Varies		DigIN Slot0.1	488	OPEN = Not active CLOSED = Active

Table 91: Overpressure supervision parameters

Index	Parameter	Min	Max	Unit	Default	ID	Description
P3.15.18.1	Enable Overpressure Supervision	0	1		0	1698	0 = Disabled 1 = Enabled
P3.15.18.2	Supervision Alarm Level	Varies	Varies	Varies	0.00	1699	

Table 92: Pump running time counter parameters

Index	Parameter	Min	Max	Unit	Default	ID	Description
P3.15.19.1	Set Runtime Counter	0	1		0	1673	0 = No action 1 = Set the value that is specified by P3.15.19.2 to the runtime counter of the selected pump.
P3.15.19.2	Set Runtime Counter: Value	0	300 000	h	0	1087	
P3.15.19.3	Set Runtime Counter: Pump Selection	0	8		1	1088	0 = All Pumps 1 = Pump (1) 2 = Pump 2 3 = Pump 3 4 = Pump 4 5 = Pump 5 6 = Pump 6 7 = Pump 7 8 = Pump 8
P3.15.19.4	Pump Runtime Alarm Limit	0	300 000	h	0	1109	0 = Not Used
P3.15.19.5	Pump Runtime Fault Limit	0	300 000	h	0	1110	0 = Not Used

Table 93: Advanced settings

Index	Parameter	Min	Max	Unit	Default	ID	Description
P3.15.22.1	Staging Frequency	P3.3.1.1	320.0	Hz	320.0	15545	
P3.15.22.2	De-staging Frequency	0.0	P3.3.1.2	Hz	0.00	15546	

5.16 GROUP 3.16: MAINTENANCE COUNTERS

Table 94: Maintenance counters

Index	Parameter	Min	Max	Unit	Default	ID	Description
P3.16.1	Counter 1 Mode	0	2		0	1104	0 = Not used 1 = Hours 2 = Revolutions * 1000
P3.16.2	Counter 1 Alarm Limit	0	2147483 647	h/kRev	0	1105	0 = Not used
P3.16.3	Counter 1 Fault Limit	0	2147483 647	h/kRev	0	1106	0 = Not used
P3.16.4	Counter 1 Reset				0	1107	
P3.16.5	Counter 1 DI Reset				0	490	CLOSED = Reset

5.17 GROUP 3.17: FIRE MODE

Table 95: Fire mode parameters

Index	Parameter	Min	Max	Unit	Default	ID	Description
P3.17.1	Fire Mode Password	0	9999		0	1599	1002 = Enabled 1234 = Test mode
P3.17.2	Fire Mode Frequency Source	0	18		0	1617	0 = Fire Mode frequency 1 = Preset speeds 2 = Keypad 3 = Fieldbus 4 = AI1 5 = AI2 6 = AI1 + AI2 7 = PID1 8 = Motor potentiometer 9 = Block Out.1 10 = Block Out.2 11 = Block Out.3 12 = Block Out.4 13 = Block Out.5 14 = Block Out.6 15 = Block Out.7 16 = Block Out.8 17 = Block Out.9 18 = Block Out.10
P3.17.3	Fire Mode Frequency	0.00	P3.3.1.2	Hz	50.00	1598	
P3.17.4	Fire Mode Activation on OPEN				DigIN Slot0.2	1596	OPEN = Fire Mode active CLOSED = No action
P3.17.5	Fire Mode Activation on CLOSE				DigIN Slot0.1	1619	OPEN = No action CLOSED = Fire Mode active
P3.17.6	Fire Mode Reverse				DigIN Slot0.1	1618	OPEN = Forward CLOSED = Reverse DigIN Slot0.1 = Forward DigIN Slot0.2 = Reverse
V3.17.7	Fire Mode Status	0	3			1597	See Table 16 Items in the monitoring menu. 0 = Disabled 1 = Enabled 2 = Activated (Enabled + DI Open) 3 = Test Mode
V3.17.8	Fire Mode Counter	0	65535			1679	

Table 95: Fire mode parameters

Index	Parameter	Min	Max	Unit	Default	ID	Description
P3.17.9	Fire Mode Run Indication Current	0	100	%	10	15580	

5.18 GROUP 3.18: MOTOR PREHEAT PARAMETERS

Table 96: Motor preheat parameters

Index	Parameter	Min	Max	Unit	Default	ID	Description
P3.18.1	Motor Preheat Function	0	3		0	1225	0 = Not used 1 = Always in stop state 2 = Controlled by DI 3 = Temperature limit, heatsink
P3.18.2	Preheat Temperature Limit	-20	100	°C/F	0	1226	
P3.18.3	Motor Preheat Current	0	0.5*IL	A	Varies	1227	
P3.18.4	Motor Preheat ON	Varies	Varies		DigIN Slot0.1	1044	OPEN = No action CLOSED = Preheat activated in Stop state

5.19 GROUP 3.19: DRIVE CUSTOMIZER

Table 97: Drive customizer parameters

Index	Parameter	Min	Max	Unit	Default	ID	Description
P3.19.1	Operation Mode	0	1		1	15001	0 = Execute Program 1 = Programming

**NOTE!**

When you use the Drive customizer, use the graphical Drive customizer tool in VACON® Live.

5.20 GROUP 3.21: PUMP CONTROL

Table 98: Auto-cleaning parameters

Index	Parameter	Min	Max	Unit	Default	ID	Description
P3.21.1.1	Cleaning Function	0	3		0	1714	0 = Disabled 1 = Enabled (DIN) 2 = Enabled (current) 3 = Enabled (weekdays)
P3.21.1.2	Cleaning Activation				DigIN Slot0.1	1715	
P3.21.1.3	Cleaning Current Limit	0.0	200.0	%	120.0	1712	
P3.21.1.4	Cleaning Current Delay	0.0	300.0	s	60.0	1713	
P3.21.1.5	Cleaning Weekdays	0	127		0	1723	B0 = Sunday B1 = Monday B2 = Tuesday B3 = Wednesday B4 = Thursday B5 = Friday B6 = Saturday
P3.21.1.6	Cleaning Time of Day	00:00:00	23:59:59		00:00:00	1700	
P3.21.1.7	Cleaning Cycles	1	100		5	1716	
P3.21.1.8	Clean Forward Frequency	0.00	50.00	Hz	45.00	1717	
P3.21.1.9	Clean Forward Time	0.00	320.00	s	2.00	1718	
P3.21.1.10	Clean Reverse Frequency	0.00	50.00	Hz	45.00	1719	
P3.21.1.11	Clean Reverse Time	0.00	320.00	s	0.00	1720	
P3.21.1.12	Cleaning Acceleration Time	0.1	300.0	s	0.1	1721	
P3.21.1.13	Cleaning Deceleration Time	0.1	300.0	s	0.1	1722	

Table 99: Jockey pump parameters

Index	Parameter	Min	Max	Unit	Default	ID	Description
P3.21.2.1	Jockey Function	0	2		0	1674	0 = Not used 1 = PID sleep 2 = PID sleep (level)
P3.21.2.2	Jockey Start Level	Varies	Varies	Varies	0.00	1675	
P3.21.2.3	Jockey Stop Level	Varies	Varies	Varies	0.00	1676	

Table 100: Priming pump parameters

Index	Parameter	Min	Max	Unit	Default	ID	Description
P3.21.3.1	Priming Function	0	1		0	1677	0 = Disabled 1 = Enabled
P3.21.3.2	Priming Time	0.0	320.00	s	3.0	1678	

Table 101: Anti-blocking parameters

Index	Parameter	Min	Max	Unit	Default	ID	Description
P3.21.4.1	Anti-blocking Interval	0	96.0	h	0	1696	
P3.21.4.2	Anti-blocking runtime	0	300	s	20	1697	
P3.21.4.3	Anti-blocking frequency	P3.3.1.1	P3.3.1.2	Hz	15.0	1504	

Table 102: Frost protection parameters

Index	Parameter	Min	Max	Unit	Default	ID	Description
P3.21.5.1	Frost Protection	0	1		0	1704	0 = Disabled 1 = Enabled
P3.21.5.2	Temperature Signal	0	29		6	1705	0 = Temperature Input 1 (-50-200 C) 1 = Temperature Input 2 (-50-200 C) 2 = Temperature Input 3 (-50-200 C) 3 = Temperature Input 4 (-50-200 C) 4 = Temperature Input 5 (-50-200 C) 5 = Temperature Input 6 (-50-200) 6 = Analogue input 1 7 = Analogue input 2 8 = Analogue input 3 9 = Analogue input 4 10 = Analogue input 5 11 = Analogue input 6 12 = ProcessDataIn1 (0-100%) 13 = ProcessDataIn2 (0-100%) 14 = ProcessDataIn3 (0-100%) 15 = ProcessDataIn4 (0-100%) 16 = ProcessDataIn5 (0-100%) 17 = ProcessDataIn6 (0-100%) 18 = ProcessDataIn7 (0-100%) 19 = ProcessDataIn8 (0-100%) 20 = Block Out.1 21 = Block Out.2 22 = Block Out.3 23 = Block Out.4 24 = Block Out.5 25 = Block Out.6 26 = Block Out.7 27 = Block Out.8 28 = Block Out.9 29 = Block Out.10
P3.21.5.3	Temperature Signal Minimum	-50.0 (°C)	P3.21.5.4.4	°C/°F	-50.0 (°C)	1706	
P3.21.5.4	Temperature Signal Maximum	P3.21.5.3	200.0 (°C)	°C/°F	200.0 (°C)	1707	

Table 102: Frost protection parameters

Index	Parameter	Min	Max	Unit	Default	ID	Description
P3.21.5.5	Frost Protection Temperature Limit	P3.21.5.3	P3.21.5.4	°C/°F	5.00 [°C]	1708	
P3.21.5.6	Frost Protection Frequency	0.0	P3.3.1.2	Hz	10.0	1710	
V3.21.5.7	Frost Temperature Monitoring	Varies	Varies	°C/°F		1711	This monitoring value shows the value of the temperature signal that is used for Frost Protection function.

Table 103: Flow switch parameters

Index	Parameter	Min	Max	Unit	Default	ID	Description
P3.21.6.1	Flow Switch				DigIN Slot0.2	15590	
P3.21.6.2	Flow Switch Fault Delay	0.0	3000.0	s	20.0	15585	
P3.21.6.3	Flow Switch Bypass at Start	0.0	3000.0	s	20.0	15586	
P3.21.6.4	Flow Switch Minimum Frequency	Varies	Varies	Hz	0.0	15587	

5.21 GROUP 3.23: ADVANCED HARMONIC FILTER

Table 104: Advanced harmonic filter parameters

Index	Parameter	Min	Max	Unit	Default	ID	Description
P3.23.1	Cap Disconnect Limit	0	100	%	0	15510	
P3.23.2	Cap Disconnect Hyst	0	100	%	0	15511	
P3.23.3	AHF Over Temperature				DigIN Slot0.1	15513	
P3.23.4	AHF Fault Response	0	3		2	15512	0 = No Action 1 = Alarm 2 = Fault 3 = Fault, Coast

6 DIAGNOSTICS MENU

6.1 ACTIVE FAULTS

When there is a fault or many faults, the display shows the name of the fault and blinks. Push OK to go back to the Diagnostics menu. The submenu Active faults shows the number of faults. To see the fault-time data, make a selection of a fault and push OK.

The fault stays active until you reset it. There are 5 ways to reset a fault.

- Push the Reset button for 2 s.
- Go into the submenu Reset faults and use the parameter Reset Faults.
- Give a reset signal in the I/O terminal.
- Give a reset signal with the fieldbus.
- Give a reset signal in VACON® Live.

The Active faults submenu can keep a storage of maximum 10 faults. The submenu shows the faults in the sequence in which they occurred.

6.2 RESET FAULTS

In this menu, you can reset faults. See instructions in Chapter 11.1 *A fault comes into view*.



CAUTION!

Before you reset the fault, remove the external Control signal to prevent that you restart the drive accidentally.

6.3 FAULT HISTORY

You can see 40 faults in the Fault history.

To see the details of a fault, go into Fault history, find the fault and push OK.

6.4 TOTAL COUNTERS

If you read a counter value through fieldbus, see 10.22 *Counters*.

Table 105: The total counter parameters in the diagnostics menu

Index	Parameter	Min	Max	Unit	Default	ID	Description
V4.4.1	Energy Counter			Varies		2291	The quantity of energy from the mains. You cannot reset the counter. In the text display: the highest energy unit that the display shows is MW. If the counted energy becomes more than 999.9 MW, no unit shows on the display.
V4.4.3	Operating Time (graphical keypad)			a d hh:min		2298	The operating time of the control unit.
V4.4.4	Operating Time (text keypad)			a			The operating time of the control unit in total years.
V4.4.5	Operating Time (text keypad)			d			The operating time of the control unit in total days.
V4.4.6	Operating Time (text keypad)			hh:min: ss			The operating time of the control unit in hours, minutes and seconds.
V4.4.7	Run Time (graphical keypad)			a d hh:min		2293	The motor run time.
V4.4.8	Run Time (text keypad)			a			The motor run time in total years.
V4.4.9	Run Time (text keypad)			d			The motor run time in total days.
V4.4.10	Run Time (text keypad)			hh:min: ss			The motor run time in hours, minutes and seconds.
V4.4.11	Power On Time (graphical keypad)			a d hh:min		2294	The quantity of time that the power unit is powered on. You cannot reset the counter.
V4.4.12	Power On Time (text keypad)			a			The power on time in total years.
V4.4.13	Power On Time (text keypad)			d			The power on time in total days.

Table 105: The total counter parameters in the diagnostics menu

Index	Parameter	Min	Max	Unit	Default	ID	Description
V4.4.14	Power On Time (text keypad)			hh:min:ss			The power on time in hours, minutes and seconds.
V4.4.15	Start Command Counter					2295	The number of times that the power unit is started.

6.5 TRIP COUNTERS

If you read a counter value through fieldbus, see Chapter 10.22 Counters.

Table 106: The trip counter parameters in the diagnostics menu

Index	Parameter	Min	Max	Unit	Default	ID	Description
P4.5.1	Energy Trip Counter			Varies		2296	<p>You can reset this counter. In the text display: the highest energy unit that the display shows is MW. If the counted energy becomes more than 999.9 MW, no unit shows on the display.</p> <p>Resetting the counter</p> <ul style="list-style-type: none"> In the text display: Push the OK button for 4 s. In the graphical display: Push OK. A Reset counter page shows. Push OK again.
P4.5.3	Operating Time (graphical keypad)			a d hh:min		2299	You can reset this counter. See instructions in P4.5.1 above.
P4.5.4	Operating Time (text keypad)			a			The operating time in total years.
P4.5.5	Operating Time (text keypad)			d			The operating time in total days.
P4.5.6	Operating Time (text keypad)			hh:min:ss			The operating time in hours, minutes and seconds.

6.6 SOFTWARE INFO

Table 107: The software info parameters in the diagnostics menu

Index	Parameter	Min	Max	Unit	Default	ID	Description
V4.6.1	Software Package (graphical keypad)						The code for the software identification
V4.6.2	Software Package ID (text keypad)						
V4.6.3	Software Package Version (text keypad)						
V4.6.4	System Load	0	100	%		2300	The load on the control unit CPU
V4.6.5	Application Name (graphical keypad)						The name of the application
V4.6.6	Application ID						The code of the application
V4.6.7	Application Version						

7 I/O AND HARDWARE MENU

In the I/O and Hardware menu, there are different settings that are related to the options. The values in this menu are raw values, that is, they are not scaled by the application.

7.1 BASIC I/O

In the Basic I/O menu, you can monitor the statuses of the inputs and the outputs.

Table 108: The basic I/O parameters in the I/O and Hardware menu

Index	Parameter	Min	Max	Unit	Default	ID	Description
V5.1.1	Digital Input 1	0	1		0	2502	Status of the digital input signal
V5.1.2	Digital Input 2	0	1		0	2503	Status of the digital input signal
V5.1.3	Digital Input 3	0	1		0	2504	Status of the digital input signal
V5.1.4	Digital Input 4	0	1		0	2505	Status of the digital input signal
V5.1.5	Digital Input 5	0	1		0	2506	Status of the digital input signal
V5.1.6	Digital Input 6	0	1		0	2507	Status of the digital input signal
V5.1.7	Analogue Input 1 Mode	1	3		3	2508	Shows the mode that is set for the analogue input signal. The selection is made with a DIP switch on the control board. 1 = 0...20mA 3 = 0...10V
V5.1.8	Analogue Input 1	0	100	%	0.00	2509	Status of the analogue input signal
V5.1.9	Analogue Input 2 Mode	1	3		3	2510	Shows the mode that is set for the analogue input signal. The selection is made with a DIP switch on the control board. 1 = 0...20mA 3 = 0...10V
V5.1.10	Analogue Input 2	0	100	%	0.00	2511	Status of the analogue input signal

Table 108: The basic I/O parameters in the I/O and Hardware menu

Index	Parameter	Min	Max	Unit	Default	ID	Description
V5.1.11	Analogue Output 1 Mode	1	3		1	2512	Shows the mode that is set for the analogue input signal. The selection is made with a DIP switch on the control board. 1 = 0...20mA 3 = 0...10V
V5.1.12	Analogue Output 1	0	100	%	0.00	2513	Status of the analogue output signal
V5.1.13	Relay Output 1	0	1		0	2514	Status of the relay output signal
V5.1.14	Relay Output 2	0	1		0	2515	Status of the relay output signal
V5.1.15	Relay Output 3	0	1		0	2516	Status of the relay output signal

7.2 OPTION BOARD SLOTS

The parameters in this menu are different for all the option boards. You see the parameters of the option board that you installed. If there is no option board in the slots C, D or E, you do not see parameters. See more about the location of the slots in Chapter 10.6.1 *Programming of digital and analogue inputs*.

When you remove an option board, the fault code 39 and the fault name *Device removed* show on the display. See Chapter 11.3 *Fault codes*.

Table 109: Option board related parameters

Menu	Function	Description
Slot C	Settings	The settings that are related to the option board
	Monitoring	Monitor the data that is related to the option board
Slot D	Settings	The settings that are related to the option board
	Monitoring	Monitor the data that is related to the option board
Slot E	Settings	The settings that are related to the option board
	Monitoring	Monitor the data that is related to the option board

7.3 REAL TIME CLOCK

Table 110: The real time clock parameters in the I/O and Hardware menu

Index	Parameter	Min	Max	Unit	Default	ID	Description
V5.5.1	Battery State	1	3			2205	Status of the battery. 1 = Not installed 2 = Installed 3 = Replace the battery
P5.5.2	Time			hh:mm:ss		2201	The current time of the day
P5.5.3	Date			dd.mm.		2202	The current date
P5.5.4	Year			yyyy		2203	The current year
P5.5.5	Daylight Saving	1	4		1	2204	The daylight saving rule 1 = Off 2 = EU: starts on the last Sunday in March, ends on the last Sunday in October 3 = US: starts on the 2nd Sunday in March, ends on the 1st Sunday in November 4 = Russia (permanent)

7.4 POWER UNIT SETTINGS

In this menu, you can change the settings of the fan, the sine filter, and the harmonic filter.

The fan operates in the optimised or the always on mode. In the optimised mode, the internal logic of the drive receives data about the temperature and controls the fan speed. After the drive goes into the Ready state, the fan stops in 5 minutes. In the always on mode, the fan operates in full speed, and does not stop.

The sine filter keeps the overmodulation depth in limits and does not let the thermal management functions decrease the switching frequency.

The harmonic filter can be enabled to avoid possible resonances in the DC-link of the AC drive.

Table 111: Power unit settings

Index	Parameter	Min	Max	Unit	Default	ID	Description
P5.6.1.1	Fan Control Mode	0	1		1	2377	0 = Always on 1 = Optimised
P5.6.4.1	Sine Filter	0	1		0	2527	0 = Not used 1 = In use
P5.6.5.1	Harmonic Filter	0	1		0	2497	0 = Not used 1 = In use

7.5 KEYPAD

Table 112: The keypad parameters in the I/O and Hardware menu

Index	Parameter	Min	Max	Unit	Default	ID	Description
P5.7.1	Timeout Time	0	60	min	0 *		The time after which the display goes back to the page that is set with parameter P5.7.2. 0 = Not used
P5.7.2	Default Page	0	4		0 *		The page that the display shows when the drive is powered up, or when the time that is set with P5.7.1 goes. If the value is set to 0, the display shows the last page that it showed. 0 = None 1 = Enter menu index 2 = Main menu 3 = Control page 4 = Multimonitor
P5.7.3	Menu Index						Set a page to be the menu index. (The selection 1 in P5.7.2.)
P5.7.4	Contrast **	30	70	%	50		Set the contrast of the display (30-70%).
P5.7.5	Backlight Time	0	60	min	5		Set the time after which the backlight of the display goes out (0-60 min). If the value is set to 0, the backlight is always on.

* = The selection of the application with parameter P1.2 Application gives the default value. See the default values in *12.1 The default values of parameters in the different applications*.

** Only available with the graphical keypad.

7.6 FIELD BUS

In the I/O and Hardware menu, there are the parameters that are related to different fieldbus boards. You can find the instructions on how to use these parameters in the related fieldbus manual.

8 USER SETTINGS, FAVOURITES AND USER LEVEL MENUS

8.1 USER SETTINGS

8.1.1 USER SETTINGS

Table 113: General settings in the user settings menu

Index	Parameter	Min	Max	Unit	Default	ID	Description
P6.1	Language Selections	Varies	Varies		Varies	802	The selection is different in all the language packages.
P6.2	Application Selection					801	Select the application.
M6.5	Parameter Backup	See Table 114 The parameter backup parameters in the user settings menu.					
M6.6	Parameter Compare						
P6.7	Drive Name						Give a name to the drive if you think that it is necessary.

8.1.2 PARAMETER BACKUP

Table 114: The parameter backup parameters in the user settings menu

Index	Parameter	Min	Max	Unit	Default	ID	Description
P6.5.1	Restore Factory Defaults					831	Restores the default parameter values and starts the Startup wizard.
P6.5.2	Save to Keypad *	0	1		0		Saves the parameter values to the control panel, for example to copy them to another drive. 0 = No 1 = Yes
P6.5.3	Restore from Keypad *						Loads the parameter values from the control panel to the drive.
B6.5.4	Save to Set 1						Keeps a customised parameter set (that is, all the parameters included in the application).
B6.5.5	Restore from Set 1						Loads the customised parameter set to the drive.
B6.5.6	Save to Set 2						Keeps another customised parameter set (that is, all the parameters included in the application).
B6.5.7	Restore from Set 2						Loads the customised parameter set 2 to the drive.

* Only available with the graphical display.

8.2 FAVOURITES



NOTE!

This menu is available on the control panel with the graphical display, but not on the control panel with the text display.



NOTE!

This menu is not available in the VACON® Live tool.

If you use the same items frequently, you can add them into Favourites. You can collect a set of parameters or monitoring signals from all the keypad menus. It is not necessary to find them in the menu structure one by one. As an alternative, add them into the Favourites folder where it is easy to find them.

ADDING AN ITEM TO THE FAVOURITES

- 1 Find the item that you want to add to Favourites. Push the OK button.

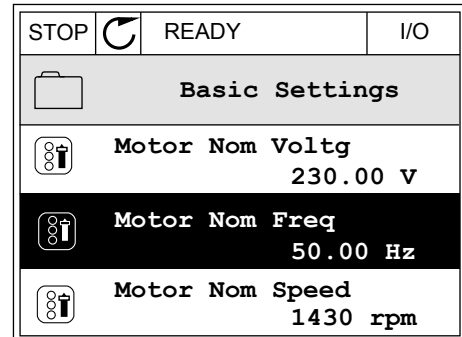

- 2 Make a selection of *Add to favourites* and push the OK button.

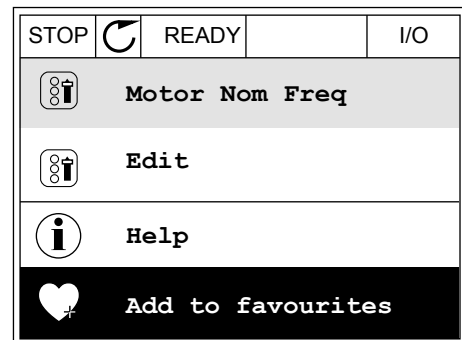

- 3 The steps are now completed. To continue, read the instructions on the display.

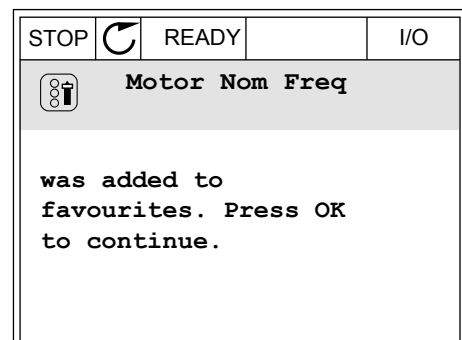

REMOVING AN ITEM FROM THE FAVOURITES

- 1 Go to the Favourites.

- 2 Find the item that you want to remove. Push the OK button.

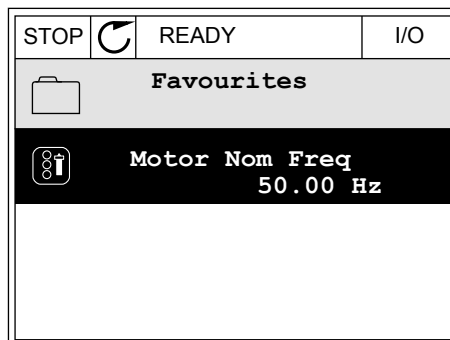

- 3 Make a selection of *Rem from favourites*.

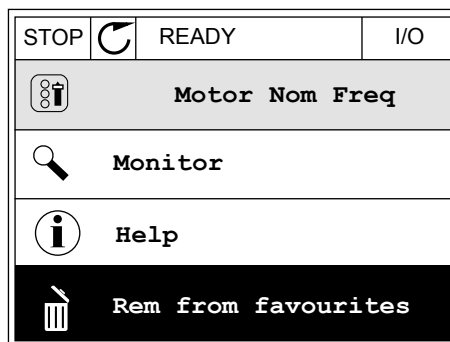

- 4 To remove the item, push the OK button again.

8.3 USER LEVELS

Use the User level parameters to keep the personnel who are not approved from making changes in the parameters. You can also prevent accidental changes in the parameters.

When you make a selection of a user level, the user cannot see all the parameters on the display of the control panel.

Table 115: The user level parameters

Index	Parameter	Min	Max	Unit	Default	ID	Description
P8.1	User Level	1	3		1	1194	1 = Normal. All the menus are visible in the main menu. 2 = Monitoring. Only the monitoring and user level menus are visible in the main menu. 3 = Favourites. Only the favourites and user level menus are visible in the main menu. 4 = Monitoring & Favourites. Monitoring, favourites and user level menus are visible in the main menu.
P8.2	Access Code	0	99999		0	2362	If you set the value to be to other than 0 before you go to <i>Monitoring</i> from, for example, <i>Normal</i> , you have to give the access code when you go back to <i>Normal</i> . This prevents personnel who are not approved from making changes in the parameters on the control panel.



CAUTION!

Do not lose the access code. If the access code is lost, contact your nearest service center or partner.

CHANGING THE ACCESS CODE OF THE USER LEVELS

- 1 Go to the User levels.

- Go to the item Access code and push the arrow button Right.

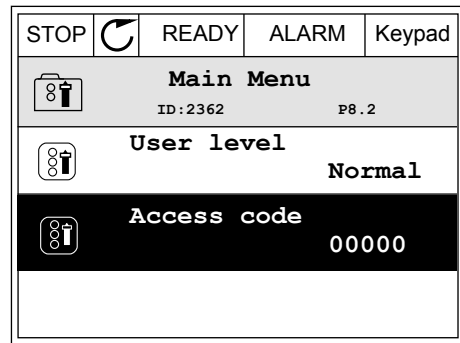

- To change the digits of the access code, use all the arrow buttons.

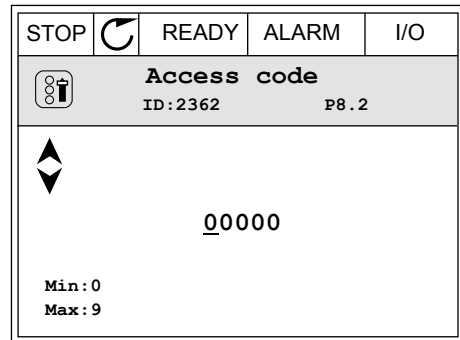

- Accept the change with the OK button.

9 MONITORING VALUE DESCRIPTIONS

This chapter gives you the basic descriptions of all monitoring values.

9.1 BASIC

V2.3.1 OUTPUT FREQUENCY (ID 1)

This monitoring value shows the actual output frequency to the motor.

V2.3.2 FREQUENCY REFERENCE (ID 25)

This monitoring value shows the actual frequency reference to the motor control. The value is updated at 10 ms interval.

V2.3.3 MOTOR SPEED (ID 2)

This monitoring value shows the actual speed of the motor in rpm (calculated value).

V2.3.4 MOTOR CURRENT (ID 3)

This monitoring value shows the measured current of the motor. The scaling of the value is different for different drive sizes.

V2.3.5 MOTOR TORQUE (ID 4)

This monitoring value shows the actual torque of the motor (calculated value).

V2.3.7 MOTOR SHAFT POWER (ID 5)

This monitoring value shows the actual shaft power of the motor (calculated value) as a percentage of the motor nominal power.

V2.3.8 MOTOR SHAFT POWER (ID 73)

This monitoring value shows the actual shaft power of the motor (calculated value). The unit of measurement is kW or hp, depending on the 'kW/hp Selection' parameter value.

The amount of decimals in the value of this monitoring value varies depending on the size of the AC drive. In fieldbus control ID 15592 can be mapped as Process Data Out to determine how many decimals are used. The last significant digit tells the amount of decimals.

V2.3.9 MOTOR VOLTAGE (ID 6)

This monitoring value shows the actual output voltage to the motor.

V2.3.10 DC LINK VOLTAGE (ID 7)

This monitoring value shows the measured voltage in the DC-link of the drive.

V2.3.11 UNIT TEMPERATURE (ID 8)

This monitoring value shows the measured heatsink temperature of the drive. The unit of the monitoring value is celsius degrees or fahrenheit degrees, depending on the 'C/F Selection' parameter value.

V2.3.12 MOTOR TEMPERATURE (ID 9)

This monitoring value shows the calculated motor temperature in percentage of the nominal working temperature. When the value rises above 105%, motor thermal protection fault occurs.

V2.3.13 MOTOR PREHEAT (ID 1228)

This monitoring value shows the status of the motor preheat function.

V2.3.15 KWH TRIP COUNTER LOW (ID 1054)

This monitoring value shows the actual value of the kWh counter (energy counter). When the value of the counter goes higher than 65535, the counter is restarted from 0.

V2.3.16 KWH TRIP COUNTER HIGH (ID 1067)

This monitoring value shows how many times the kWh counter (energy counter) has spinned around.

9.2 I/O**V2.4.1 SLOTA DIN 1,2,3 (ID 15)**

This monitoring value shows the status of the digital inputs 1-3 in slot A (standard I/O).

V2.4.2 SLOTA DIN 4,5,6 (ID 16)

This monitoring value shows the status of the digital inputs 4-6 in slot A (standard I/O).

V2.4.3 SLOTB RO 1,2,3 (ID 17)

This monitoring value shows the status of the relay outputs 1-3 in slot B.

V2.4.4 ANALOG INPUT 1 (ID 59)

This monitoring value shows the value of the analogue input signal as a percentage of the used range.

V2.4.5 ANALOG INPUT 2 (ID 60)

This monitoring value shows the value of the analogue input signal as a percentage of the used range.

V2.4.6 ANALOG INPUT 3 (ID 61)

This monitoring value shows the value of the analogue input signal as a percentage of the used range.

V2.4.7 ANALOG INPUT 4 (ID 62)

This monitoring value shows the value of the analogue input signal as a percentage of the used range.

V2.4.8 ANALOG INPUT 5 (ID 75)

This monitoring value shows the value of the analogue input signal as a percentage of the used range.

V2.4.9 ANALOG INPUT 6 (ID 76)

This monitoring value shows the value of the analogue input signal as a percentage of the used range.

V2.4.10 SLOTA AO 1 (ID 81)

This monitoring value shows the value of the analogue output as a percentage of the used range.

9.3 TEMPERATURE INPUTS

The monitoring values related to temperature input settings are only available if a B8 or BH option board is installed.

V2.5.1 TEMPERATURE INPUT 1 (ID 50)

This monitoring value shows the measured value of the temperature.
The unit of the monitoring value is celsius degrees or fahrenheit degrees, depending on the 'C/F Selection' parameter value.

**NOTE!**

The list of temperature inputs is made of the first 6 available temperature inputs. The list starts from slot A and ends in slot E. If an input is available but no sensor is connected, the list shows the maximum value because the measured resistance is endless. To make the value go to its minimum value, hardwire the input.

V2.5.2 TEMPERATURE INPUT 2 (ID 51)

This monitoring value shows the measured value of the temperature.
The unit of the monitoring value is celsius degrees or fahrenheit degrees, depending on the 'C/F Selection' parameter value.

V2.5.3 TEMPERATURE INPUT 3 (ID 52)

This monitoring value shows the measured value of the temperature.

The unit of the monitoring value is celsius degrees or fahrenheit degrees, depending on the 'C/F Selection' parameter value.

V2.5.4 TEMPERATURE INPUT 4 (ID 69)

This monitoring value shows the measured value of the temperature.

The unit of the monitoring value is celsius degrees or fahrenheit degrees, depending on the 'C/F Selection' parameter value.

V2.5.5 TEMPERATURE INPUT 5 (ID 70)

This monitoring value shows the measured value of the temperature.

The unit of the monitoring value is celsius degrees or fahrenheit degrees, depending on the 'C/F Selection' parameter value.

V2.5.6 TEMPERATURE INPUT 6 (ID 71)

This monitoring value shows the measured value of the temperature.

The unit of the monitoring value is celsius degrees or fahrenheit degrees, depending on the 'C/F Selection' parameter value.

9.4 EXTRAS AND ADVANCED

V2.6.1 DRIVE STATUS WORD (ID 43)

This monitoring value shows the bit-coded status of drive.

V2.6.2 READY STATUS (ID 78)

This monitoring value shows the bit-coded data about the Ready criteria of the drive.

This data is useful for monitoring when the drive is not in the Ready state.



NOTE!

The values are visible as checkboxes on the graphical display. If a box is selected, the value is active.

V2.6.3 APPLICATION STATUS WORD 1 (ID 89)

This monitoring value shows the bit-coded statuses of the application.



NOTE!

The values are visible as checkboxes on the graphical display. If a box is selected, the value is active.

V2.6.4 APPLICATION STATUS WORD 2 (ID 90)

This monitoring value shows the bit-coded statuses of the application.

**NOTE!**

The values are visible as checkboxes on the graphical display. If a box is selected, the value is active.

V2.6.5 DIN STATUS WORD 1 (ID 56)

This monitoring value shows the bit-coded status of the digital input signals. The monitoring value is a 16 bit word, where each bit shows the status of 1 digital input. From each slot, 6 digital inputs are read. Word 1 starts from the input 1 in slot A (bit0) and ends with input 4 in slot C (bit15).

V2.6.6 DIN STATUS WORD 2 (ID 57)

This monitoring value shows the bit-coded status of the digital input signals. The monitoring value is a 16 bit word, where each bit shows the status of 1 digital input. From each slot, 6 digital inputs are read. Word 2 starts from the input 5 in slot C (bit0) and ends with input 6 in slot E (bit13).

V2.6.7 MOTOR CURRENT 1 DECI (ID 45)

This monitoring value shows the measured current of the motor with the fixed number of decimals and that is less filtered. This monitoring value can be used for example with fieldbus to get the correct value so that the enclosure size does not have an effect, or for monitoring when less filtering time is needed for the motor current.

V2.6.8 FREQUENCY REFERENCE SOURCE (ID 1495)

This monitoring value shows the momentary frequency reference source.

V2.6.9 LAST ACTIVE FAULT CODE (ID 37)

This monitoring value shows the fault code of latest activated fault that is not reset.

V2.6.10 LAST ACTIVE FAULT ID (ID 95)

This monitoring value shows the fault ID of latest activated fault that is not reset.

V2.6.11 LAST ACTIVE ALARM CODE (ID 74)

This monitoring value shows the alarm code of latest activated alarm that is not reset.

V2.6.12 LAST ACTIVE ALARM ID (ID 94)

This monitoring value shows the alarm ID of latest activated alarm that is not reset.

V2.6.13 MOTOR REGULATOR STATUS (ID 77)

This monitoring value shows the bit-coded status of the motor limit controllers.

**NOTE!**

The values are visible as checkboxes on the graphical display. If a box is selected, the limit controller is active.

V2.6.14 MOTOR SHAFT POWER 1 DECIMAL (ID 98)

This monitoring value shows the actual shaft power of the motor (calculated value with one decimal). The unit of measurement is kW or hp, depending on the 'kW/hp Selection' parameter value.

9.5 TIMER FUNCTIONS**V2.7.1 TC 1, TC 2, TC 3 (ID 1441)**

This monitoring value shows the status of the time channels 1, 2 and 3.

V2.7.2 INTERVAL 1 (ID 1442)

This monitoring value shows the status of the interval function.

V2.7.3 INTERVAL 2 (ID 1443)

This monitoring value shows the status of the interval function.

V2.7.4 INTERVAL 3 (ID 1444)

This monitoring value shows the status of the interval function.

V2.7.5 INTERVAL 4 (ID 1445)

This monitoring value shows the status of the interval function.

V2.7.6 INTERVAL 5 (ID 1446)

This monitoring value shows the status of the interval function.

V2.7.7 TIMER 1 (ID 1447)

The monitoring value shows the remaining time on the timer if the timer is active.

V2.7.8 TIMER 2 (ID 1448)

The monitoring value shows the remaining time on the timer if the timer is active.

V2.7.9 TIMER 3 (ID 1449)

The monitoring value shows the remaining time on the timer if the timer is active.

V2.7.10 REAL TIME CLOCK (ID 1450)

This monitoring value shows the actual time of the real time clock in a format of hh:mm:ss.

9.6 PID CONTROLLER

V2.8.1 PID SETPOINT (ID 20)

This monitoring value shows the value of the PID setpoint signal in process units. You can use the parameter P3.13.1.7 to select the process unit (See *10.14.1 Basic settings*).

V2.8.2 PID FEEDBACK (ID 21)

This monitoring value shows the value of the PID feedback signal in process units. You can use the parameter P3.13.1.7 to select the process unit (See *10.14.1 Basic settings*).

V2.8.3 PID FEEDBACK (1) (ID 15541)

This monitoring value shows the value of the PID feedback signal 1 in process units.

V2.8.4 PID FEEDBACK (2) (ID 15542)

This monitoring value shows the value of the PID feedback signal 2 in process units.

V2.8.5 PID ERROR (ID 22)

This monitoring value shows the error value of the PID controller.

V2.8.6 PID OUTPUT (ID 23)

This monitoring value shows the output of the PID controller as a percentage (0-100%).

V2.8.7 PID STATUS (ID 24)

This monitoring value shows the state of the PID controller.

9.7 EXTERNAL PID CONTROLLER

V2.9.1 EXTPID SETPOINT (ID 83)

This monitoring value shows the value of the PID setpoint signal in process units. You can use the parameter P3.14.1.10 to select the process unit (See *10.14.1 Basic settings*).

V2.9.2 EXTPID FEEDBACK (ID 84)

This monitoring value shows the value of the PID feedback signal in process units. You can use the parameter P3.14.1.10 to select the process unit (See *10.14.1 Basic settings*).

V2.9.3 EXTPID ERROR (ID 85)

This monitoring value shows the error value of the PID controller. The error value is the deviation of PID feedback from the PID setpoint in process unit. You can use the parameter P3.14.1.10 to select the process unit (See *10.14.1 Basic settings*).

V2.9.4 EXTPID OUTPUT (ID 86)

This monitoring value shows the output of the PID controller as a percentage (0-100%). You can give this value to, for example, the analogue output.

V2.9.5 EXTPID STATUS (ID 87)

This monitoring value shows the state of the PID controller.

9.8 MULTI-PUMP**V2.10.1 MOTORS RUNNING (ID 30)**

This monitoring value shows the actual number of motors that operate in the Multi-pump system.

V2.10.2 AUTOCHANGE (ID 1114)

This monitoring value shows the status of the autochange requested.

V2.10.3 NEXT AUTOCHANGE (ID 1503)

This monitoring value shows the time that remains to next autochange.

V2.10.4 OPERATE MODE (ID 1505)

This monitoring value shows the operation mode of the drive in the Multi-pump system.

V2.10.5 MULTI-PUMP STATUS (ID 1628)

This monitoring value shows the status of the drive in the Multi-pump system.

V2.10.6 COMMUNICATION STATUS (ID 1629)

This monitoring value shows status of the communication between the drives in the Multi-pump system.

V2.10.7 PUMP (1) RUNNING TIME (ID 1620)

This monitoring value shows the operating hours of the pump in Multi-pump system.

V2.10.8 PUMP 2 RUNNING TIME (ID 1621)

This monitoring value shows the operating hours of the pump in Multi-pump system.

V2.10.9 PUMP 3 RUNNING TIME (ID 1622)

This monitoring value shows the operating hours of the pump in Multi-pump system.

V2.10.10 PUMP 4 RUNNING TIME (ID 1623)

This monitoring value shows the operating hours of the pump in Multi-pump system.

V2.10.11 PUMP 5 RUNNING TIME (ID 1624)

This monitoring value shows the operating hours of the pump in Multi-pump system.

V2.10.12 PUMP 6 RUNNING TIME (ID 1625)

This monitoring value shows the operating hours of the pump in Multi-pump system.

V2.10.13 PUMP 7 RUNNING TIME (ID 1626)

This monitoring value shows the operating hours of the pump in Multi-pump system.

V2.10.14 PUMP 8 RUNNING TIME (ID 1627)

This monitoring value shows the operating hours of the pump in Multi-pump system.

9.9 MAINTENANCE COUNTERS**V2.11.1 MAINTENANCE COUNTER 1 (ID 1101)**

This monitoring value shows the status of the maintenance counter.

The status of the maintenance counter is shown as revolutions multiplied by 1000, or in hours. For the configuration and activation of this counter, see *10.17 Maintenance counters*.

9.10 FIELDBUS DATA**V2.12.1 FB CONTROL WORD (ID 874)**

This monitoring value shows the status of the fieldbus control word that the application uses in bypass mode.

Depending on the fieldbus type or profile, the data that is received from the fieldbus can be modified before it is sent to the application.

Table 116: Fieldbus Control Word

Bit	Descriptions	
	Value = 0 (FALSE)	Value = 1 (TRUE)
Bit 0	Stop request from Fieldbus	Start request from Fieldbus
Bit 1	Forward direction request	Reverse direction request
Bit 2	No action	Reset active faults and alarms (on rising edge 0=>1)
Bit 3	No action	Force stop mode to Coasting
Bit 4	No action	Force stop mode to Ramping
Bit 5	No action (normal deceleration ramp time)	Force drive to use fast deceleration ramp time (1/3 of normal deceleration time)
Bit 6	No action	Freeze drive frequency reference
Bit 7	No action	Force Fieldbus frequency reference to zero
Bit 8	No action	Force drive control place to Fieldbus control
Bit 9	No action	Force drive reference source to Fieldbus reference
Bit 10	Reserved	Reserved
Bit 11	Reserved	Reserved
Bit 12	No action	Activate Quick Stop function NOTE! This will stop the drive according to setting in parameter menu M3.8.5.
Bit 13	Reserved	Reserved
Bit 14	Reserved	Reserved
Bit 15	Reserved	Reserved

V2.12.2 FB SPEED REFERENCE (ID 875)

This monitoring value shows the fieldbus frequency reference as a percentage of minimum frequency to maximum frequency.

The speed reference information is scaled between the minimum and the maximum frequency at the moment when the application received it. You can change the minimum and the maximum frequencies after the application received the reference without an effect on the reference.

V2.12.3 FB DATA IN 1 (ID 876)

This monitoring value shows the raw value of process data in a 32-bit signed format.

V2.12.4 FB DATA IN 2 (ID 877)

This monitoring value shows the raw value of process data in a 32-bit signed format.

V2.12.5 FB DATA IN 3 (ID 878)

This monitoring value shows the raw value of process data in a 32-bit signed format.

V2.12.6 FB DATA IN 4 (ID 879)

This monitoring value shows the raw value of process data in a 32-bit signed format.

V2.12.7 FB DATA IN 5 (ID 880)

This monitoring value shows the raw value of process data in a 32-bit signed format.

V2.12.8 FB DATA IN 6 (ID 881)

This monitoring value shows the raw value of process data in a 32-bit signed format.

V2.12.9 FB DATA IN 7 (ID 882)

This monitoring value shows the raw value of process data in a 32-bit signed format.

V2.12.10 FB DATA IN 8 (ID 883)

This monitoring value shows the raw value of process data in a 32-bit signed format.

V2.12.11 FB STATUS WORD (ID 864)

This monitoring value shows the status of the fieldbus status word that the application uses in bypass mode.

Depending on the fieldbus type or profile, the data can be modified before it is sent to the fieldbus.

Table 117: Fieldbus Status Word

Bit	Descriptions	
	Value = 0 (FALSE)	Value = 1 (TRUE)
Bit 0	Not ready to operate	Ready to operate
Bit 1	Not running	Running
Bit 2	Running in the Forward direction	Running in the Reverse direction
Bit 3	No fault	Fault is active
Bit 4	No alarm	Alarm is active
Bit 5	Requested speed not reached	Running at requested speed
Bit 6	Actual speed of the drive not zero	Actual speed of the drive is zero
Bit 7	Motor not magnetized (flux not ready)	Motor magnetized (flux ready)
Bit 8	Reserved	Reserved
Bit 9	Reserved	Reserved
Bit 10	Reserved	Reserved
Bit 11	Reserved	Reserved
Bit 12	Reserved	Reserved
Bit 13	Reserved	Reserved
Bit 14	Reserved	Reserved
Bit 15	Reserved	Reserved

V2.12.12 FB SPEED ACTUAL (ID 865)

This monitoring value shows the actual speed of the drive as a percentage of minimum frequency and maximum frequency.

The value 0% indicates the minimum frequency and the value 100% indicates the maximum frequency. This monitoring value is continuously updated depending on the momentary min and max frequencies and the output frequency.

V2.12.13 FB DATA OUT 1 (ID 866)

This monitoring value shows the raw value of process data in a 32-bit signed format.

V2.12.14 FB DATA OUT 2 (ID 867)

This monitoring value shows the raw value of process data in a 32-bit signed format.

V2.12.15 FB DATA OUT 3 (ID 868)

This monitoring value shows the raw value of process data in a 32-bit signed format.

V2.12.16 FB DATA OUT 4 (ID 869)

This monitoring value shows the raw value of process data in a 32-bit signed format.

V2.12.17 FB DATA OUT 5 (ID 870)

This monitoring value shows the raw value of process data in a 32-bit signed format.

V2.12.18 FB DATA OUT 6 (ID 871)

This monitoring value shows the raw value of process data in a 32-bit signed format.

V2.12.19 FB DATA OUT 7 (ID 872)

This monitoring value shows the raw value of process data in a 32-bit signed format.

V2.12.20 FB DATA OUT 8 (ID 873)

This monitoring value shows the raw value of process data in a 32-bit signed format.

9.11 DRIVE CUSTOMIZER**V2.13.2 BLOCK OUT.1 (ID 15020)**

This monitoring value shows the value of the function block output in the Drive customizer function.

V2.13.3 BLOCK OUT.2 (ID 15040)

This monitoring value shows the value of the function block output in the Drive customizer function.

V2.13.4 BLOCK OUT.3 (ID 15060)

This monitoring value shows the value of the function block output in the Drive customizer function.

V2.13.5 BLOCK OUT.4 (ID 15080)

This monitoring value shows the value of the function block output in the Drive customizer function.

V2.13.6 BLOCK OUT.5 (ID15100)

This monitoring value shows the value of the function block output in the Drive customizer function.

V2.13.7 BLOCK OUT.6 (ID 15120)

This monitoring value shows the value of the function block output in the Drive customizer function.

V2.13.8 BLOCK OUT.7 (ID 15140)

This monitoring value shows the value of the function block output in the Drive customizer function.

V2.13.9 BLOCK OUT.8 (ID 15160)

This monitoring value shows the value of the function block output in the Drive customizer function.

V2.13.10 BLOCK OUT.9 (ID 15180)

This monitoring value shows the value of the function block output in the Drive customizer function.

V2.13.11 BLOCK OUT.10 (ID 15200)

This monitoring value shows the value of the function block output in the Drive customizer function.

10 PARAMETER DESCRIPTIONS

In this chapter, you can find information on all the parameters of your VACON® 100 application. If other information is necessary, see chapter 5 *Parameters menu* or contact your nearest distributor.

P1.2 APPLICATION (ID212)

Use this parameter to select the application configuration for the drive. The applications include preset application configurations, that is, sets of predefined parameters. The selection of the application makes the commissioning of the drive easy and reduces the manual work with the parameters.

When the value of this parameter changes, a group of parameteres get their preset values. You can change the value of this parameter when you make the start up or the commissioning of the drive.

If you use the control panel to change this parameter, an application wizard starts and helps you to set the basic parameters related to the application. The wizard does not start, if you use the PC tool to change this parameter. You can find data about the application wizards in Chapter 2 *Wizards*.

These applications are available:

- 0 = Standard
- 1 = HVAC
- 2 = PID control
- 3 = Multi-pump (single drive)
- 4 = Multi-pump (multidrive)



NOTE!

When you change the application, the contents of the Quick Setup menu change.

10.1 TREND CURVE

P2.2.2 SAMPLING INTERVAL (ID 2368)

Use this parameter to set the sampling interval.

P2.2.3 CHANNEL 1 MIN (ID 2369)

This parameter is used in scaling by default. Adjustments can be necessary.

P2.2.4 CHANNEL 1 MAX (ID 2370)

This parameter is used in scaling by default. Adjustments can be necessary.

P2.2.5 CHANNEL 2 MIN (ID 2371)

This parameter is used in scaling by default. Adjustments can be necessary.

P2.2.6 CHANNEL 2 MAX (ID 2372)

This parameter is used in scaling by default. Adjustments can be necessary.

P2.2.7 AUTOSCALE (ID 2373)

Use this parameter to set autoscaling on or off. If autoscaling is enabled, the signal is automatically scaled between the minimum and maximum values.

10.2 MOTOR SETTINGS**10.2.1 MOTOR NAMEPLATE PARAMETERS****P3.1.1.1 MOTOR NOMINAL VOLTAGE (ID 110)**

Find the value U_n on the nameplate of the motor. Find out whether the motor connection is Delta or Star.

P3.1.1.2 MOTOR NOMINAL FREQUENCY (ID 111)

Find the value f_n on the nameplate of the motor. When this parameter changes, parameters P3.1.4.2 Field Weakening Point Frequency and P3.1.4.3 Voltage at Field Weakening Point start automatically. The 2 parameters have different values for each motor type. See the tables in *P3.1.2.2 Motor Type (ID 650)*.

P3.1.1.3 MOTOR NOMINAL SPEED (ID 112)

Find the value n_n on the nameplate of the motor.

P3.1.1.4 MOTOR NOMINAL CURRENT (ID 113)

Find the value I_n on the nameplate of the motor.

P3.1.1.5 MOTOR COS PHI (ID 120)

Find the value on the nameplate of the motor.

P3.1.1.6 MOTOR NOMINAL POWER (ID 116)

Find the value P_n on the nameplate of the motor.

10.2.2 MOTOR CONTROL PARAMETERS

P3.1.2.2 MOTOR TYPE (ID 650)

Use this parameter to set the type of motor in your process.

Selection number	Selection name	Description
0	Induction motor (IM)	Make this selection if you use an induction motor.
1	Permanent Magnet Motor (PM)	Make this selection if you use a permanent magnet motor.
2	Reluctance Motor	Make this selection if you use a reluctance motor.

When you change the value of parameter P3.1.2.2 Motor Type, the values of parameters P3.1.4.2 Field Weakening Point Frequency and P3.1.4.3 Voltage at Field Weakening Point change automatically, as the table below shows. The 2 parameters have different values for each motor type.

Parameter	Induction motor (IM)	Permanent magnet motor (PM)
P3.1.4.2 (Field Weakening Point Frequency)	Motor nominal frequency	Internally calculated
P3.1.4.3 (Voltage at Field Weakening Point)	100.0%	Internally calculated

P3.1.2.3 SWITCHING FREQUENCY (ID 601)

Use this parameter to set the switching frequency of the AC drive.

If you increase the switching frequency, the capacity of the AC drive reduces. To reduce capacitive currents in the motor cable, when the cable is long, we recommend that you use a low switching frequency. To reduce the motor noise, use a high switching frequency.

P3.1.2.4 IDENTIFICATION (ID 631)

Use this parameter to find the parameter values that are optimal for the operation of the drive.

The identification run calculates or measures the motor parameters that are necessary for a good control of the motor and speed.

The identification run helps you to adjust the motor-specific and the drive-specific parameters. It is a tool for the commissioning and the servicing of the drive.



NOTE!

Before you do the identification run, you have to set the motor nameplate parameters.

Selection number	Selection name	Description
0	No action	No identification requested.
1	Identification at standstill	The drive operates without speed when you do the identification run for the motor parameters. The motor receives current and voltage, but the frequency is zero. The U/f ratio and start magnetisation parameters are identified.
2	Identification with rotation	The drive operates with speed when you do the identification run for the motor parameters. The U/f ratio, the magnetisation current and start magnetisation parameters are identified. To get accurate results, do this identification run with no load on the motor shaft.

To activate the Identification function, set the parameter P3.1.2.4 and give a start command. You have to give the start command in 20 s. If there is no start command in that time, the identification run does not start. The parameter P3.1.2.4 is reset to the default value and an identification alarm shows.

To stop the identification run before it is completed, give a stop command. This resets the parameter to the default value. If the identification run is not completed, an identification alarm shows.

**NOTE!**

To start the drive after the identification, a new start command is necessary.

P3.1.2.5 MAGNETIZING CURRENT (ID 612)

Use this parameter to set the magnetising current of the motor. The magnetising current (no-load current) of the motor identifies the values of the U/f parameters if they are given before the identification run. If the value is set to 0, the magnetising current is calculated internally.

P3.1.2.6 MOTOR SWITCH (ID 653)

Use this parameter to enable the Motor Switch function. You can use the Motor Switch function, if the cable that connects the motor and the drive has a motor switch. The operation of the motor switch makes sure that the motor is isolated from the voltage source and does not start during the servicing.

To activate the function, set the parameter P3.1.2.6 to the value *Enabled*. The drive stops automatically when the motor switch is opened, and the drive starts automatically when the motor switch is closed. The drive does not trip when you use the Motor switch function.

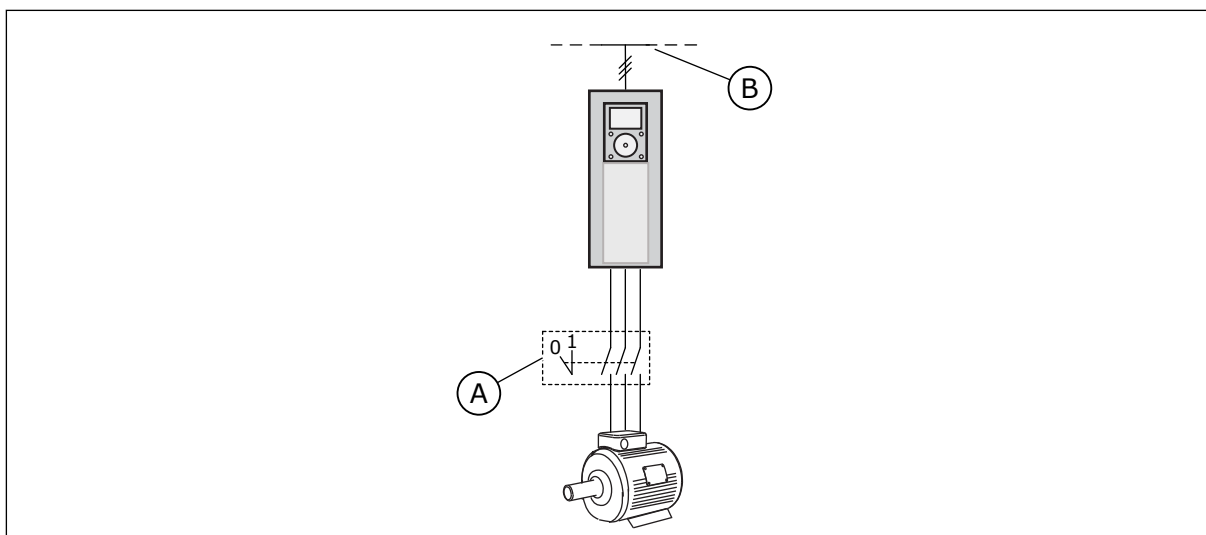

Fig. 36: The motor switch between the drive and the motor

A. The motor switch

B. Mains

P3.1.2.10 OVERVOLTAGE CONTROL (ID 607)

Use this parameter to set the overvoltage controller out of operation.

The function is necessary when

- the supply voltage changes, for example, between -15% and +10%, and
- the process you control does not have the tolerance for the changes that the undervoltage controller and the overvoltage controller make to the output frequency of the drive.

The overvoltage controller increases the output frequency of the drive

- to keep the DC link voltage in the permitted limits, and
- to make sure that the drive does not trip because of an overvoltage fault.



NOTE!

The drive can trip when the overvoltage and undervoltage controllers are disabled.

P3.1.2.11 UNDERVOLTAGE CONTROL (ID 608)

Use this parameter to set the undervoltage controller out of operation.

The function is necessary when

- the supply voltage changes, for example, between -15% and +10%, and
- the process you control does not have the tolerance for the changes that the undervoltage controller and the overvoltage controller make to the output frequency of the drive.

The undervoltage controller decreases the output frequency of the drive

- to get energy from the motor to keep the DC link voltage at a minimum level when the voltage is near the lowest permitted limit, and
- to make sure that the drive does not trip because of an undervoltage fault.

**NOTE!**

The drive can trip when the overvoltage and undervoltage controllers are disabled.

P3.1.2.12 ENERGY OPTIMIZATION (ID 666)

Use this parameter to enable the Energy Optimization function.

To save energy and to lower the motor noise, the drive searches for the minimum motor current. You can use this function for example in fan and pump processes. Do not use the function with fast PID controlled processes.

P3.1.2.13 STATOR VOLTAGE ADJUST (ID 659)

Use this parameter to adjust the stator voltage in permanent magnet motors.

**NOTE!**

The identification run sets a value for this parameter automatically. We recommend that you make the identification run, if it is possible. You can make the identification run with the parameter P3.1.2.4.

It is possible to use this parameter only when the parameter P3.1.2.2 Motor Type has the value *PM motor*. If you set *induction motor* as the motor type, the value is automatically set to 100%, and you cannot change the value.

When you change the value of P3.1.2.2 (Motor type) to *PM Motor*, the parameters P3.1.4.2 (Field Weakening Point Frequency) and P3.1.4.3 (Voltage at Field Weakening Point) will increase automatically to be equal with output voltage of the drive. The set U/f ratio does not change. This is done to prevent the operation of the PM motor in the field weakening area. The nominal voltage of the PM motor is much lower than the full output voltage of the drive.

The nominal voltage of the PM motor agrees to the back-EMF voltage of the motor at nominal frequency. But in a different motor manufacturer, it can be equal to, for example, the stator voltage at nominal load.

Stator Voltage Adjust helps you to adjust the U/f curve of the drive near the back-EMF curve. It is not necessary to change the values of many U/f curve parameters.

The parameter P3.1.2.13 gives the output voltage of the drive in percentage of the nominal voltage of the motor at the nominal frequency of the motor. Adjust the U/f curve of the drive above the back-EMF curve of the motor. The motor current increases the more the U/f curve is different from the back-EMF curve.

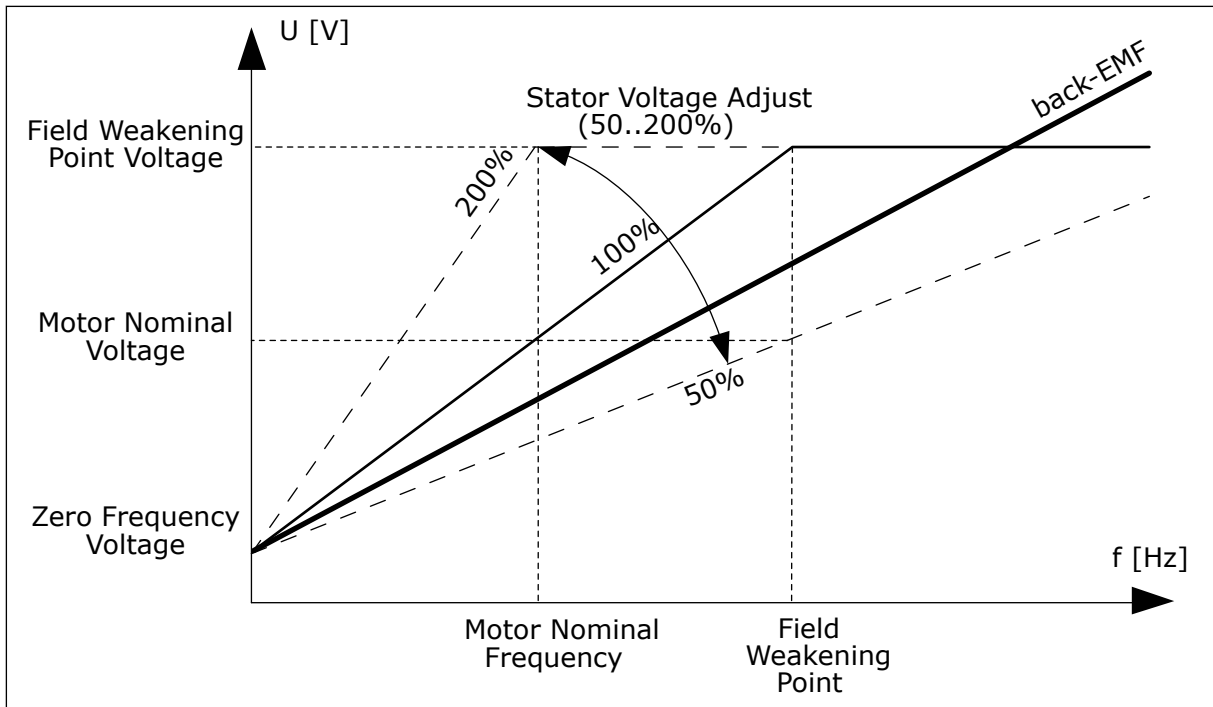

Fig. 37: The stator voltage adjustment

P3.1.2.15 STATOR RESISTANCE VOLTAGE DROP (ID 662)

Use this parameter to set the motor stator phase-resistance value (in star-connection equivalent circuit). The resistance is essential for an accurate motor control.

The value is given as a percentage of voltage drop at nominal current.



NOTE!

The identification run sets a value for this parameter automatically. We recommend that you make the identification run, if it is possible. You can make the identification run with the parameter P3.1.2.4.

P3.1.2.16 STATOR INDUCTANCE VOLTAGE DROP (ID 673)

Use this parameter to set the motor stator phase-inductance value (in star-connection equivalent circuit). The value is the transient inductance (for induction motors) or the line-to-neutral inductance (for permanent magnet and reluctance motors).

The value is given as a percentage of voltage drop at nominal current and nominal frequency.



NOTE!

The identification run sets a value for this parameter automatically. We recommend that you make the identification run, if it is possible. You can make the identification run with the parameter P3.1.2.4.

P3.1.2.17 MOTOR BEM VOLTAGE (ID 674)

Use this parameter to set the back electromotive force (back-EMF) voltage of a permanent magnet motor. The value of this parameter is the motor terminal voltage when the motor current is zero.

The value is given as line-to-line RMS voltage at nominal operating frequency. Identification at standstill uses this parameter to set U/f curve in open loop control mode. The back-EMF value that is identified in Identification with rotation overwrites the existing parameter value.

10.2.3 MOTOR LIMITS

P3.1.3.1 MOTOR CURRENT LIMIT (ID 107)

Use this parameter to set the maximum motor current from the AC drive. The range of values for the parameter is different for each enclosure size of the drive.

When the current limit is active, the drive output frequency decreases.



NOTE!

The Motor Current Limit is not an overcurrent trip limit.

P3.1.3.2 MOTOR TORQUE LIMIT (ID 1287)

Use this parameter to set the maximum torque limit of the motoring side. The range of values for the parameter is different for each enclosure size of the drive.

10.2.4 OPEN LOOP PARAMETERS

P3.1.4.1 U/F RATIO (ID 108)

Use this parameter to set the type of the U/f curve between zero frequency and the field weakening point.

Selection number	Selection name	Description
0	Linear	The voltage of the motor changes linearly as a function of the output frequency. The voltage changes from the value of P3.1.4.6 (Zero Frequency Voltage) to the value of P3.1.4.3 (Voltage at Field Weakening Point) at a frequency set in P3.1.4.2 (Field Weakening Point Frequency). Use this default setting if a different setting is not necessary.
1	Squared	The voltage of the motor changes from the value of P3.1.4.6 (Zero Frequency Voltage) to the value of P3.1.4.2 (Field Weakening Point Frequency) at a squared curve. The motor operates undermagnetised below the field weakening point and produces less torque. You can use the squared U/f ratio in applications where the torque demand is in relation to the square of the speed, for example in centrifugal fans and pumps.
2	Programmable	It is possible to program the U/f curve with 3 different points: the zero frequency voltage (P1), the midpoint voltage/frequency (P2), and the field weakening point (P3). You can use the programmable U/f curve at low frequencies if it is necessary to have more torque. You can find the optimal settings automatically with an identification run (P3.1.2.4).

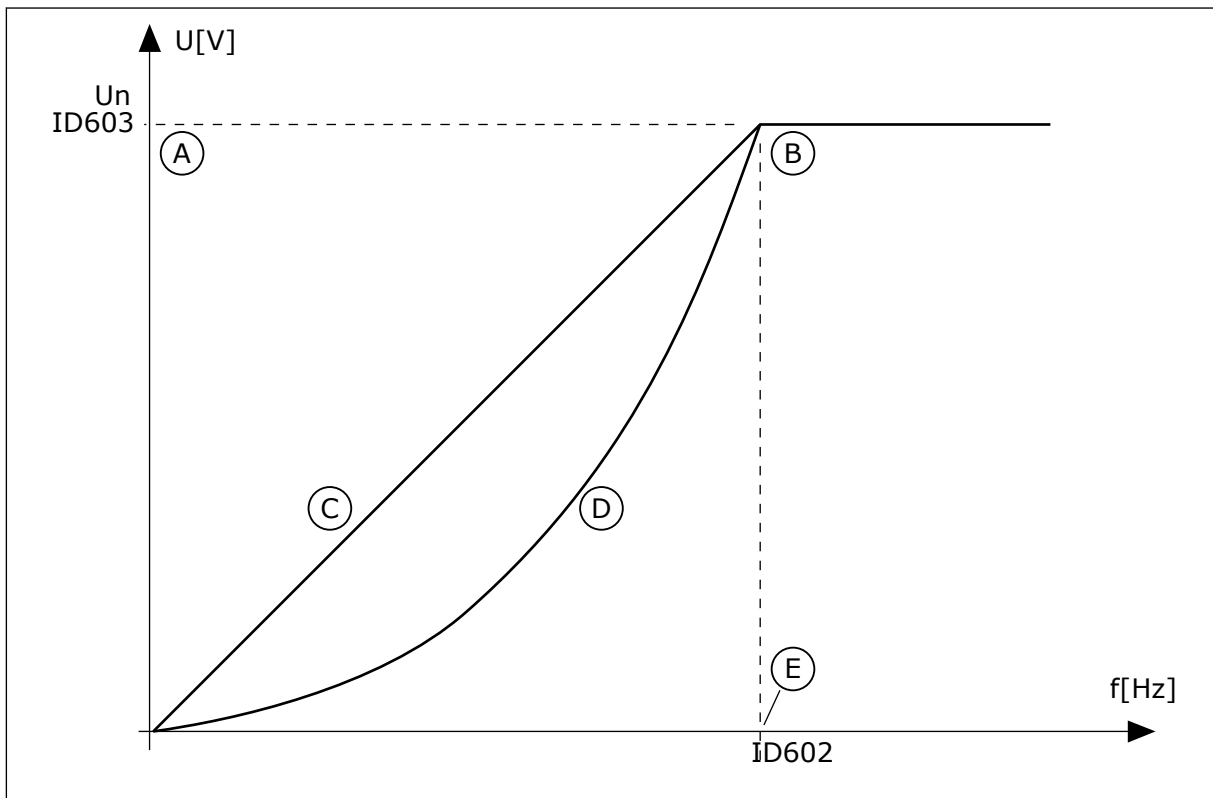

Fig. 38: Linear and squared change of the motor voltage

- A. Default: Nominal voltage of the motor
- B. Field weakening point
- C. Linear
- D. Squared
- E. Default: Nominal frequency of the motor

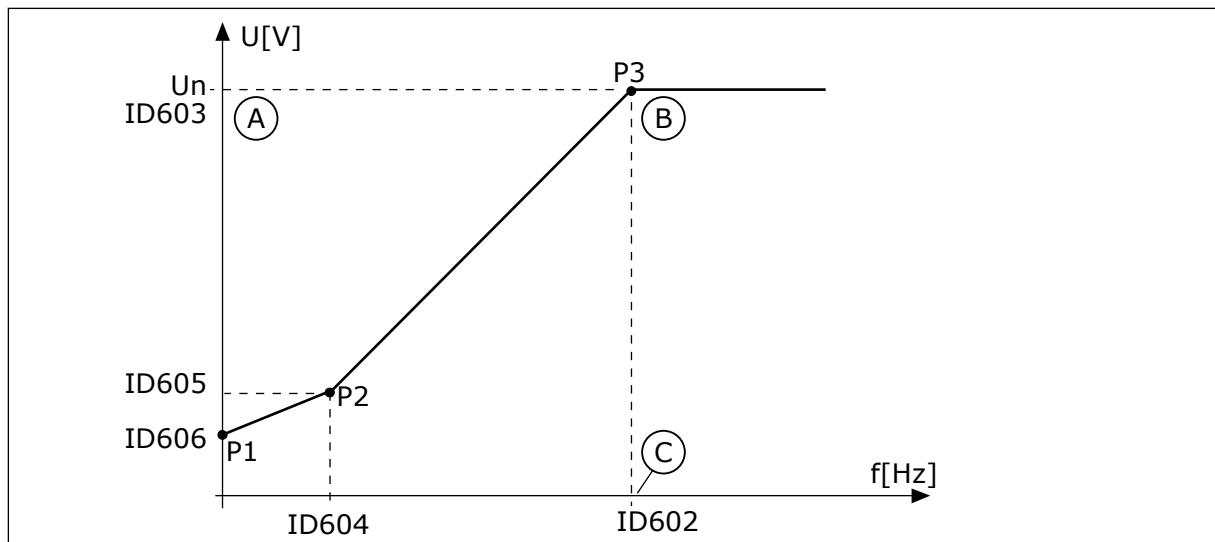

Fig. 39: The programmable U/f curve

- A. Default: Nominal voltage of the motor C. Default: Nominal frequency of the motor
 B. Field weakening point

When the parameter Motor Type has the value *PM motor (Permanent Magnet Motor)*, this parameter is automatically set to the value *Linear*.

When the parameter Motor Type has the value *Induction Motor*, and when this parameter is changed, these parameters are set to their default values.

- P3.1.4.2 Field Weakening Point Frequency
- P3.1.4.3 Voltage at Field Weakening Point
- P3.1.4.4 U/f Midpoint Frequency
- P3.1.4.5 U/f Midpoint Voltage
- P3.1.4.6 Zero Frequency Voltage

P3.1.4.2 FIELD WEAKENING POINT FREQUENCY (ID 602)

Use this parameter to set the output frequency at which the output voltage reaches the field weakening point voltage.

P3.1.4.3 VOLTAGE AT FIELD WEAKENING POINT (ID 603)

Use this parameter to set the voltage at the field weakening point as a percentage of the motor nominal voltage.

Above the frequency at the field weakening point, the output voltage stays at the set maximum value. Below the frequency at the field weakening point, the U/f curve parameters control the output voltage. See the U/f parameters P3.1.4.1, P3.1.4.4 and P3.1.4.5.

When you set the parameters P3.1.1.1 (Motor nominal voltage) and P3.1.1.2 (Motor nominal frequency), the parameters P3.1.4.2 and P3.1.4.3 automatically receive related values. To have different values for P3.1.4.2 and P3.1.4.3, change these parameters only after you set the parameters P3.1.1.1 and P3.1.1.2.

P3.1.4.4 U/F MIDPOINT FREQUENCY (ID 604)

Use this parameter to set the middle point frequency of the U/f curve.



NOTE!

This parameter gives the middle point frequency of the curve if the value of P3.1.4.1 is *programmable*.

P3.1.4.5 U/F MIDPOINT VOLTAGE (ID 605)

Use this parameter to set the middle point voltage of the U/f curve.



NOTE!

This parameter gives the middle point voltage of the curve if the value of P3.1.4.1 is *programmable*.

P3.1.4.6 ZERO FREQUENCY VOLTAGE (ID 606)

Use this parameter to set the zero frequency voltage of the U/f curve. The default value for the parameter is different for each unit size.

P3.1.4.7 FLYING START OPTIONS (ID 1590)

Use this parameter to set the flying start options. The parameter Flying Start Options has a checkbox selection of values.

The bits can receive these values.

- Search the shaft frequency only from the same direction as the frequency reference
- Disable the AC scanning
- Use the frequency reference for an initial guess
- Disable the DC pulses
- Flux build with current control

The bit B0 controls the search direction. When you set the bit to 0, the shaft frequency is searched in 2 directions, the positive and the negative. When you set the bit to 1, the shaft frequency is searched only in the frequency reference direction. This prevents the shaft movements for the other direction.

The bit B1 controls the AC scanning that premagnetises the motor. In the AC scanning, the system sweeps the frequency from the maximum towards zero frequency. The AC scanning stops when an adaptation to the shaft frequency occurs. To disable the AC scanning, set the bit B1 to 1. If the value of Motor Type is permanent magnet motor, the AC scanning is disabled automatically.

With the bit B5 you can disable the DC pulses. The primary function of the DC pulses is to premagnetise the motor and examine the rotation of the motor. If the DC pulses and the AC scanning are enabled, the slip frequency tells which procedure is applied. If the slip frequency is less than 2 Hz, or the motor type is PM motor, the DC pulses are disabled automatically.

The bit B7 controls the rotation direction of the injected high frequency signal, which is used in the flying start of synchronous reluctance machines. Signal injection is used to detect the frequency of the rotor. If the rotor is in a blind angle when the signal is injected, the rotor frequency is undetectable. Reversing the rotation direction of the injection signal solves this problem.

P3.1.4.8 FLYING START SCAN CURRENT (ID 1610)

Use this parameter to set the flying start scan current as a percentage of the motor nominal current.

P3.1.4.9 START BOOST (ID 109)

Use this parameter with a process that has a high start torque because of friction. You can use the start boost only when you start the drive. The start boost is deactivated after 10 seconds or when the output frequency of the drive is more than half of the frequency of the field weakening point.

The voltage to the motor changes in relation to the necessary torque. This makes the motor give more torque at the start and when the motor operates at low frequencies.

The start boost has an effect with a linear U/f curve. You can get the best result when you have done the identification run and activated the programmable U/f curve.

10.2.5 I/F START FUNCTION

When you have a PM motor, use the I/f Start function to start the motor with constant current control. You can receive the best effect with a high power motor. With a high power motor, the resistance is low and it is not easy to change the U/f curve.

The I/f Start function can also give a sufficient torque for the motor at startup.

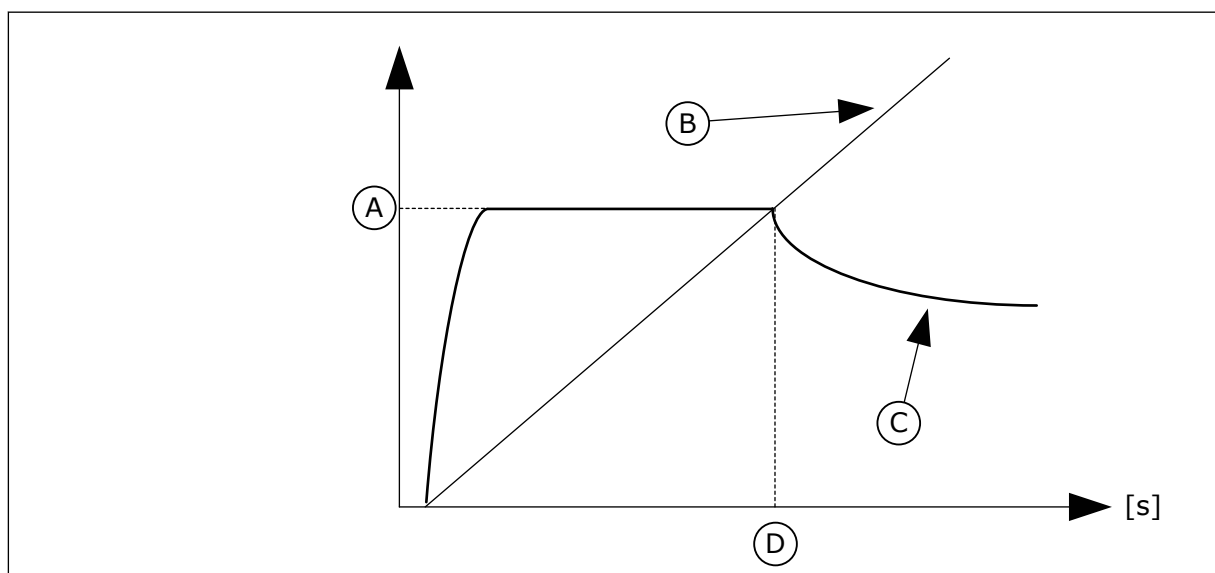

Fig. 40: The I/f start parameters

- | | |
|----------------------|------------------------|
| A. I/f Start Current | C. Motor Current |
| B. Output Frequency | D. I/f Start Frequency |

P3.1.4.12.1 I/F START (ID 534)

Use this parameter to enable the I/f Start function.

When you activate the I/f Start function, the drive starts to operate in the current control mode. A constant current is led to the motor until the output frequency increases above the level that is set in P3.1.4.12.2. When the output frequency increases above I/f Start Frequency level, the operation mode changes back to the normal U/f control mode.

P3.1.4.12.2 I/F START FREQUENCY (ID 535)

Use this parameter to set the output frequency limit below which the set I/f start current is fed to motor.

When the output frequency of the drive is below the limit of this parameter, I/f Start function activates. When the output frequency is more than the limit, the drive operation mode changes back to the normal U/f control mode.

P3.1.4.12.3 I/F START CURRENT (ID 536)

Use this parameter to set the current that is used when the I/f Start function is enabled.

10.2.6 TORQUE STABILATOR FUNCTION**P3.1.4.13.1 TORQUE STABILATOR GAIN (ID 1412)**

Use this parameter to set the gain of the torque stabilator in an open loop control operation.

P3.1.4.13.2 TORQUE STABILATOR GAIN AT FIELD WEAKENING POINT (ID 1414)

Use this parameter to set the gain of the torque stabilator at field weakening point in an open loop control operation.

The torque stabiliser stabilises the possible oscillations in the estimated torque.

Two gains are used. TorqStabGainFWP is a constant gain at all the output frequencies. TorqStabGain changes linearly between the zero frequency and the field weakening point frequency. The full gain is at 0 Hz and the gain is zero at the field weakening point. The figure shows the gains as a function of output frequency.

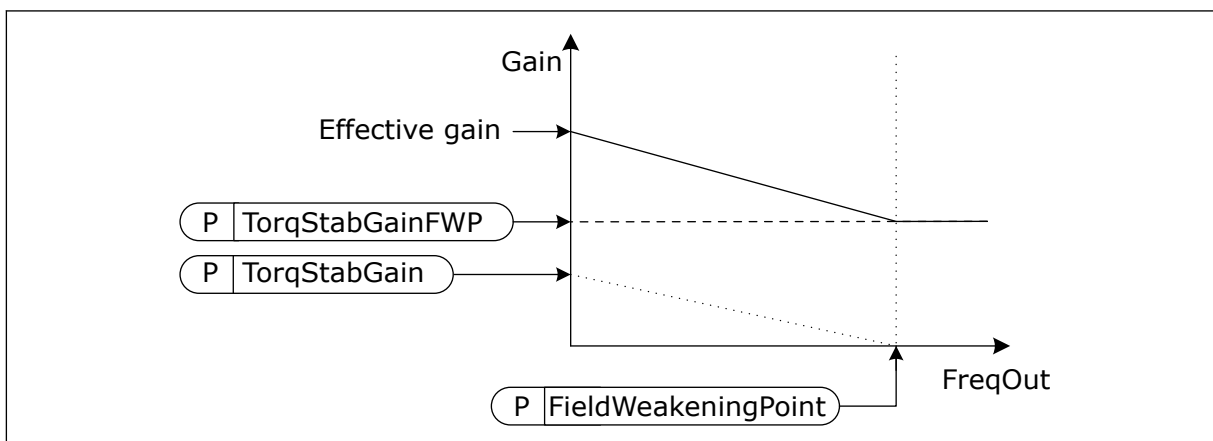

Fig. 41: The torque stabilator gain

P3.1.4.13.3 TORQUE STABILATOR DAMPING TIME CONSTANT (ID 1413)

Use this parameter to set the damping time constant of the torque stabiliser.

P3.1.4.13.4 TORQUE STABILATOR DAMPING TIME CONSTANT FOR PM MOTORS (ID 1735)

Use this parameter to set the damping time constant of the torque stabiliser for permanent magnet or reluctance motors.

P3.1.4.13.5 TORQUE STABILATOR FILTER TIME CONSTANT (ID 15650)

Use this parameter to set the lowpass filtering time constant of the torque stabilizer.

P3.1.4.13.6 TORQUE STABILATOR FILTER TIME CONSTANT FOR PM MOTORS (ID 15651)

Use this parameter to set the lowpass filtering time constant of the torque stabilizer for permanent magnet or reluctance motors.

10.3 START/STOP SETUP

The drive is started and stopped from a control place. Each control place has a different parameter to select the source of the frequency reference. You must give the start and stop commands in each control place.

The local control place is always the keypad. With parameter P3.2.1 Remote Control Place you can select the remote control place (I/O or Fieldbus). The selected control place shows on the status bar of the keypad.

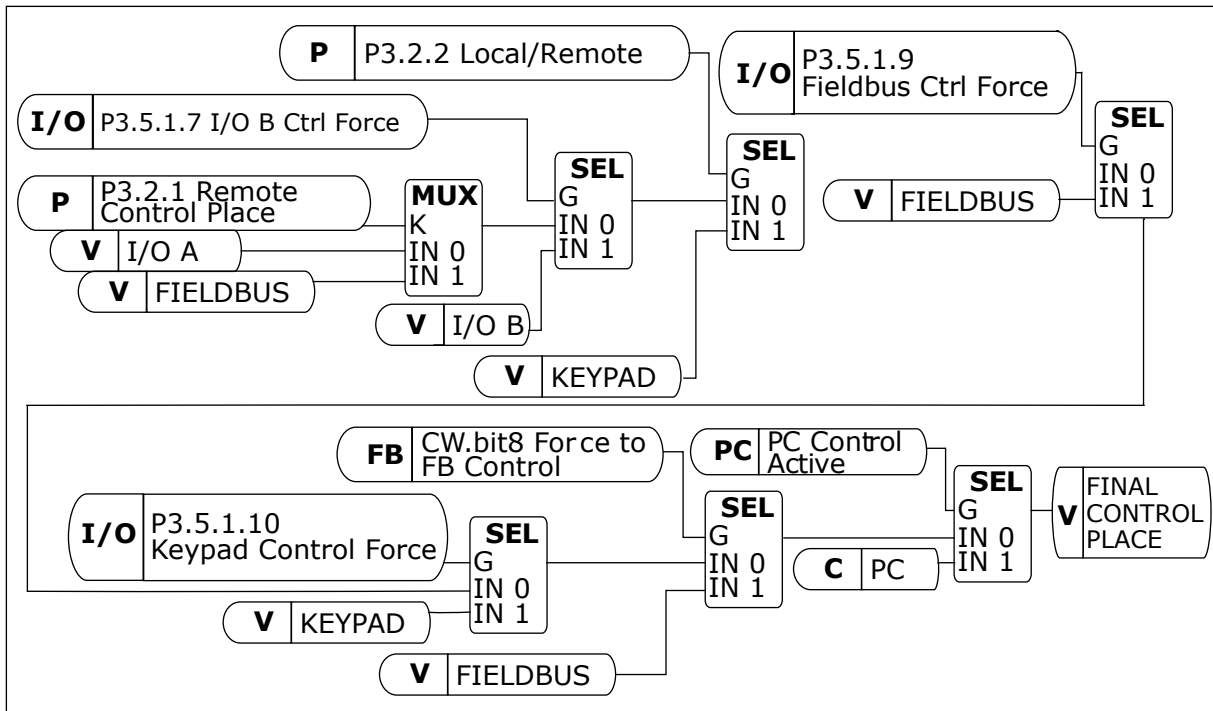

Fig. 42: Control place

REMOTE CONTROL PLACE (I/O A)

Use the parameters P3.5.1.1 (Control signal 1 A), P3.5.1.2 (Control signal 2 A) and P3.5.1.3 (Control signal 3 A) to make a selection of digital inputs. These digital inputs control the start, stop and reverse commands. Then make a selection of a logic for these inputs with P3.2.6 I/O A Logic.

REMOTE CONTROL PLACE (I/O B)

Use the parameters P3.5.1.4 (Control signal 1 B), P3.5.1.5 (Control signal 2 B) and P3.5.1.6 (Control signal 3 B) to make a selection of digital inputs. These digital inputs control the start, stop and reverse commands. Then make a selection of a logic for these inputs with P3.2.7 I/O B Logic.

LOCAL CONTROL PLACE (KEYPAD)

The start and stop commands come from the keypad buttons. The direction of the rotation is set with parameter P3.3.1.9 Keypad direction.

REMOTE CONTROL PLACE (FIELDBUS)

Start, stop and reverse commands come from the fieldbus.

P3.2.1 REMOTE CONTROL PLACE (ID 172)

Use this parameter to select the remote control place (start/stop).

Use this parameter to change back to remote control from VACON® Live, for example if the control panel is broken.

P3.2.2 LOCAL/REMOTE (ID 211)

Use this parameter to switch between the local and remote control places. Local control place is always keypad control. The remote control place can be I/O or Fieldbus, depending on the 'Remote Control Place' parameter value.

P3.2.3 KEYPAD STOP BUTTON (ID 114)

Use this parameter to enable the keypad stop button. When this function is enabled, a press of keypad stop button always stops the drive (regardless of the control place). When this function is disabled, a press of keypad stop button stops the drive in local control only.

Selection number	Selection name	Description
0	Yes	The keypad stop button is always enabled.
1	No	Limited function of the keypad stop button.

P3.2.4 START FUNCTION (ID 505)

Use this parameter to select the type of the start function.

Selection number	Selection name	Description
0	Ramping	The drive accelerates from 0 frequency to frequency reference.
1	Flying start	The drive detects the actual speed of the motor and accelerates from that speed to frequency reference.

P3.2.5 STOP FUNCTION (ID 506)

Use this parameter to select the type of the stop function.

Selection number	Selection name	Description
0	Coasting	The motor stops on its inertia. When the stop command is given, the control by the drive stops and the current from the drive goes to 0.
1	Ramp	After the stop command, the speed of the motor is decreased to zero speed according to the deceleration parameters.

**NOTE!**

Ramp stop cannot be guaranteed in all situations. If ramp stop is selected and the net voltage changes over 20%, the voltage estimation fails. In such case, ramp stop is not possible.

P3.2.6 I/O A START/STOP LOGIC (ID 300)

Use this parameter to control the start and stop of the drive with the digital signals. The selections can include the word 'edge' to help you prevent an accidental start.

An accidental start can occur, for example, in these conditions

- When you connect the power.
- When the power is connected again after a power cut.
- After you reset a fault.
- After Run Enable stops the drive.
- When you change the control place to I/O control.

Before you can start the motor, you must open the Start/Stop contact.

In all the examples of the next pages, the stop mode is coasting. CS = Control signal.

Selection number	Selection name	Description
0	CS1 = Forward CS2 = Backward	The functions activate when the contacts are closed.

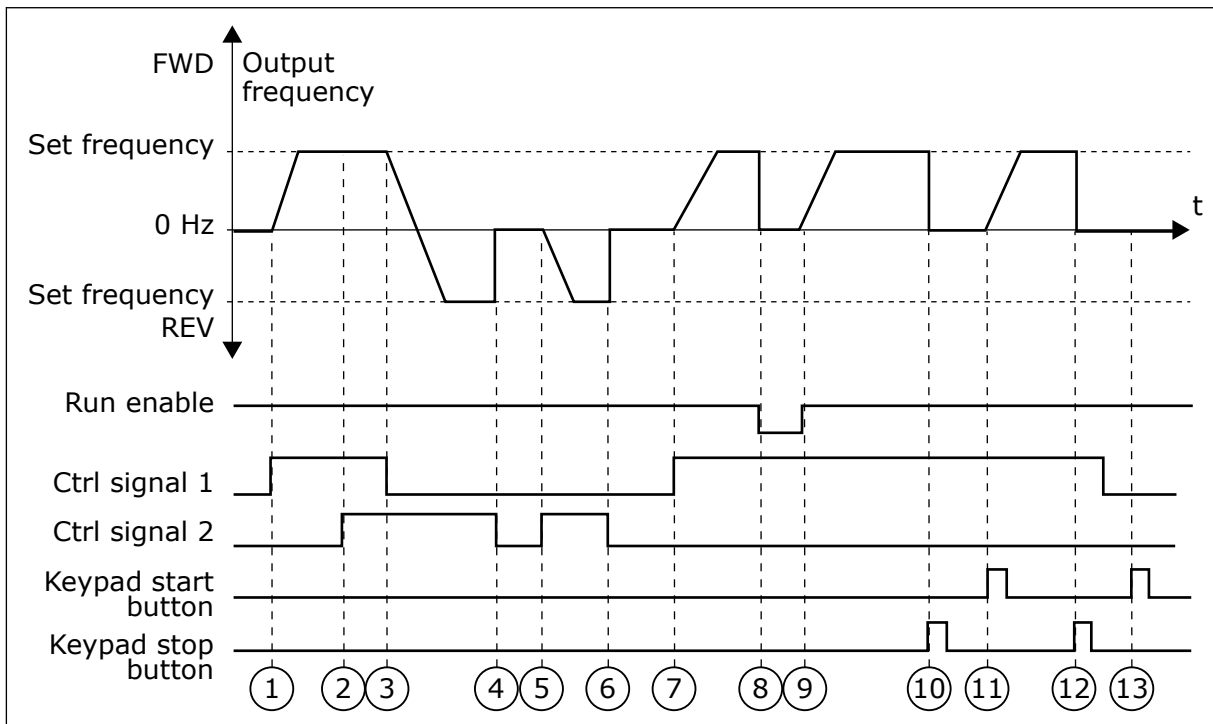

Fig. 43: I/O A Start/stop logic = 0

1. Control signal (CS) 1 activates and causes the output frequency to increase. The motor operates forward.
2. CS2 activates, but it does not have an effect on the output frequency, because the direction that is set first has the highest priority.

3. CS1 becomes inactive and causes the direction to start to change (FWD to REV), because CS2 is still active.
4. CS2 becomes inactive and the frequency that is fed to the motor goes to 0.
5. CS2 activates again and causes the motor to accelerate (REV) to the set frequency.
6. CS2 becomes inactive and the frequency fed to the motor drops to 0.
7. CS1 activates and the motor accelerates (FWD) to the set frequency
8. The Run enable signal is set to OPEN, which causes the frequency to go to 0. Configure the Run enable signal with parameter P3.5.1.15.
9. The Run enable signal is set to CLOSED, which causes the frequency to increase to the set frequency, because CS1 is still active.
10. The STOP button on the keypad is pushed, and the frequency that is fed to the motor goes to 0. (This signal only works if the value of P3.2.3 Keypad Stop Button is Yes.)
11. The drive starts because the START button on the keypad was pushed.
12. The STOP button on the keypad is pushed again to stop the drive.
13. The attempt to start the drive with the START button is not successful, because CS1 is inactive.

Selection number	Selection name	Description
1	CS1 = Forward (edge) CS2 = Inverted stop CS3 = Backward (edge)	For a 3-wire control (pulse control)

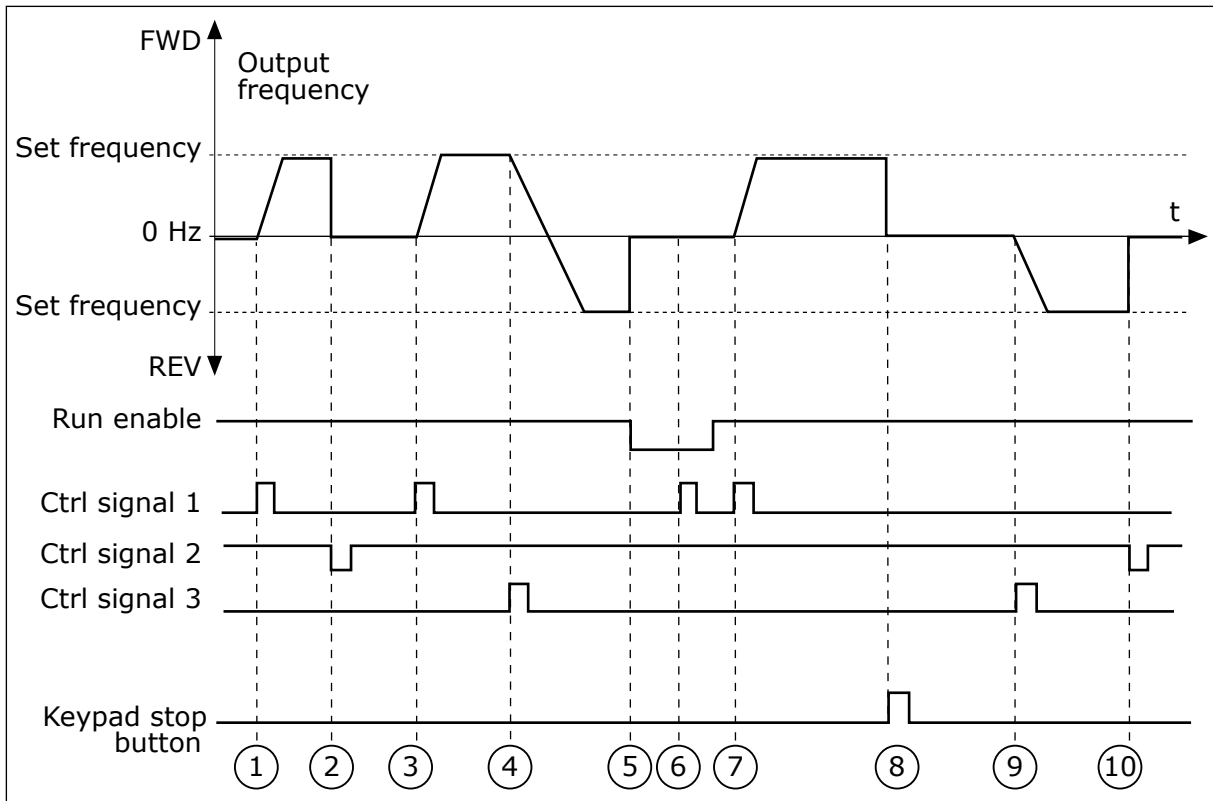

Fig. 44: I/O A Start/stop logic = 1

1. Control signal (CS) 1 activates and causes the output frequency to increase. The motor operates forward.
2. CS2 becomes inactive and causes the frequency to go to 0.
3. CS1 activates and causes the output frequency to increase again. The motor operates forward.
4. CS3 activates and causes the direction to start to change (FWD to REV).
5. The Run enable signal is set to OPEN, which causes the frequency to go to 0. Configure the Run enable signal with parameter 3.5.1.15.
6. The start attempt with CS1 is not successful, because the Run enable signal is still OPEN.
7. CS1 activates and the motor accelerates (FWD) to the set frequency, because the Run enable signal was set to CLOSED.
8. The STOP button on the keypad is pushed, and the frequency that is fed to the motor goes to 0. (This signal only works if the value of P3.2.3 Keypad Stop Button is Yes.)
9. CS3 activates and causes the motor to start and to operate in the reverse direction.
10. CS2 becomes inactive and causes the frequency to go to 0.

Selection number	Selection name	Description
2	CS1 = Forward (edge) CS2 = Backward (edge)	Use this function to prevent an accidental start. Before you can start the motor again, you must open the start/stop contact.

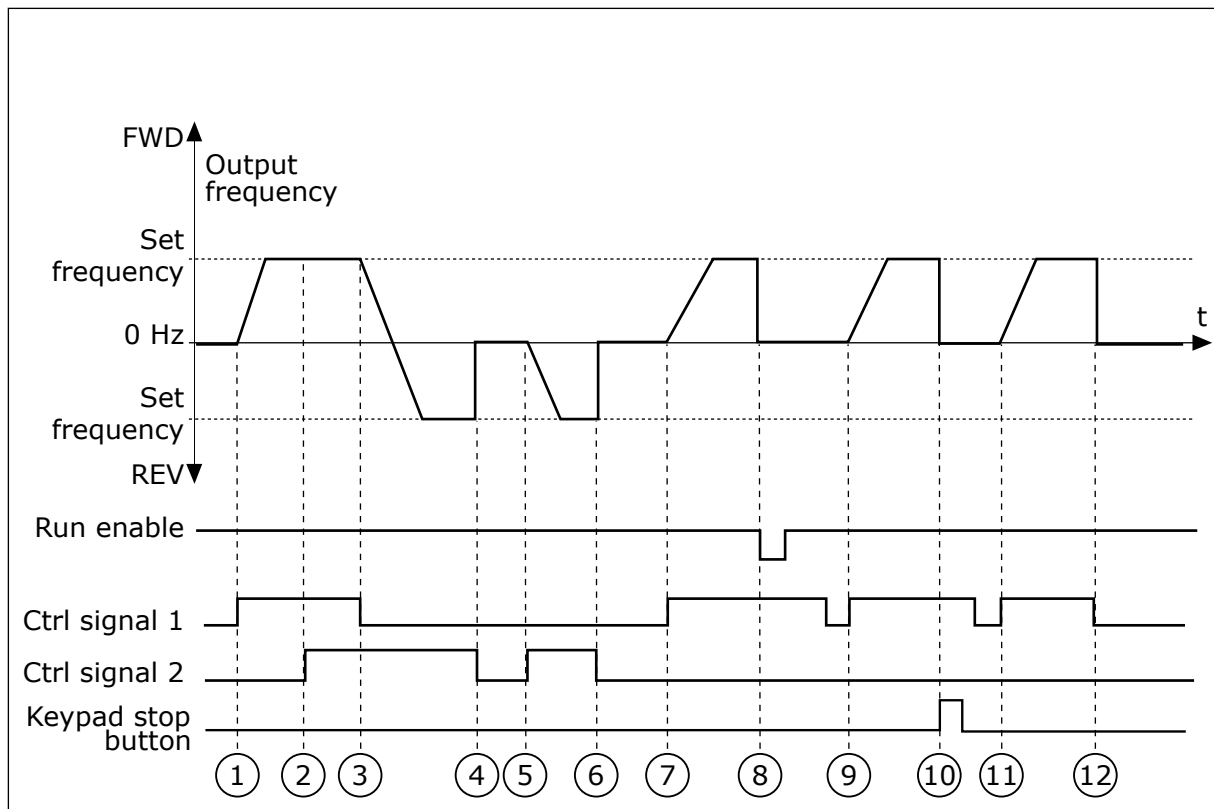

Fig. 45: I/O A Start/stop logic = 2

1. Control signal (CS) 1 activates and causes the output frequency to increase. The motor operates forward.
2. CS2 activates, but it does not have an effect on the output frequency, because the direction that is set first has the highest priority.
3. CS1 becomes inactive and causes the direction to start to change (FWD to REV), because CS2 is still active.
4. CS2 becomes inactive and the frequency that is fed to the motor goes to 0.
5. CS2 activates again and causes the motor to accelerate (REV) to the set frequency.
6. CS2 becomes inactive and the frequency that is fed to the motor goes to 0.
7. CS1 activates and the motor accelerates (FWD) to the set frequency.
8. The Run enable signal is set to OPEN, which causes the frequency to go to 0. Configure the Run enable signal with parameter P3.5.1.15.
9. The Run enable signal is set to CLOSED, which does not have an effect, because a rising edge is necessary for the start, even if CS1 is active.
10. The STOP button on the keypad is pushed and the frequency that is fed to the motor goes to 0. (This signal only works if the value of P3.2.3 Keypad Stop Button is Yes.)
11. CS1 is opened and closed again, which causes the motor to start.
12. CS1 becomes inactive and the frequency that is fed to the motor goes to 0.

Selection number	Selection name	Description
3	CS1 = Start CS2 = Reverse	

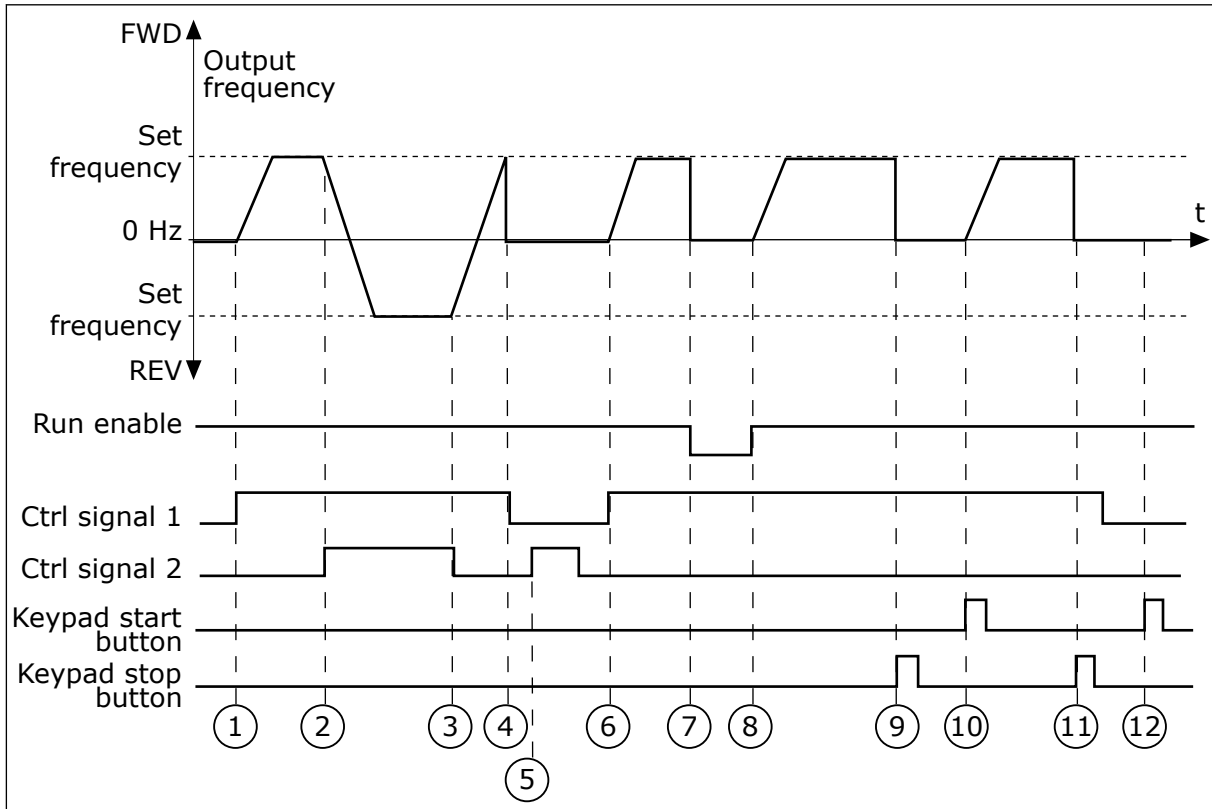

Fig. 46: I/O A Start/stop logic = 3

- Control signal (CS) 1 activates and causes the output frequency to increase. The motor operates forward.
- CS2 activates and causes the direction to start to change (FWD to REV).
- CS2 becomes inactive, which causes the direction to start to change (REV to FWD), because CS1 is still active.
- CS1 becomes inactive and the frequency goes to 0.
- CS2 activates, but the motor does not start because CS1 is inactive.
- CS1 activates and causes the output frequency to increase again. The motor operates forward because CS2 is inactive.
- The Run enable signal is set to OPEN, which causes the frequency to go to 0. Configure the Run enable signal with parameter P3.5.1.15.
- The Run enable signal is set to CLOSED, which causes the frequency to increase to the set frequency, because CS1 is still active.
- The STOP button on the keypad is pushed and the frequency that is fed to the motor goes to 0. (This signal only works if the value of P3.2.3 Keypad Stop Button is Yes.)
- The drive starts because the START button on the keypad was pushed.
- The drive is stopped again with the STOP button on the keypad.

12. The attempt to start the drive with the START button is not successful, because CS1 is inactive.

Selection number	Selection name	Description
4	CS1 = Start (edge) CS2 = Reverse	Use this function to prevent an accidental start. Before you can start the motor again, you must open the start/stop contact.

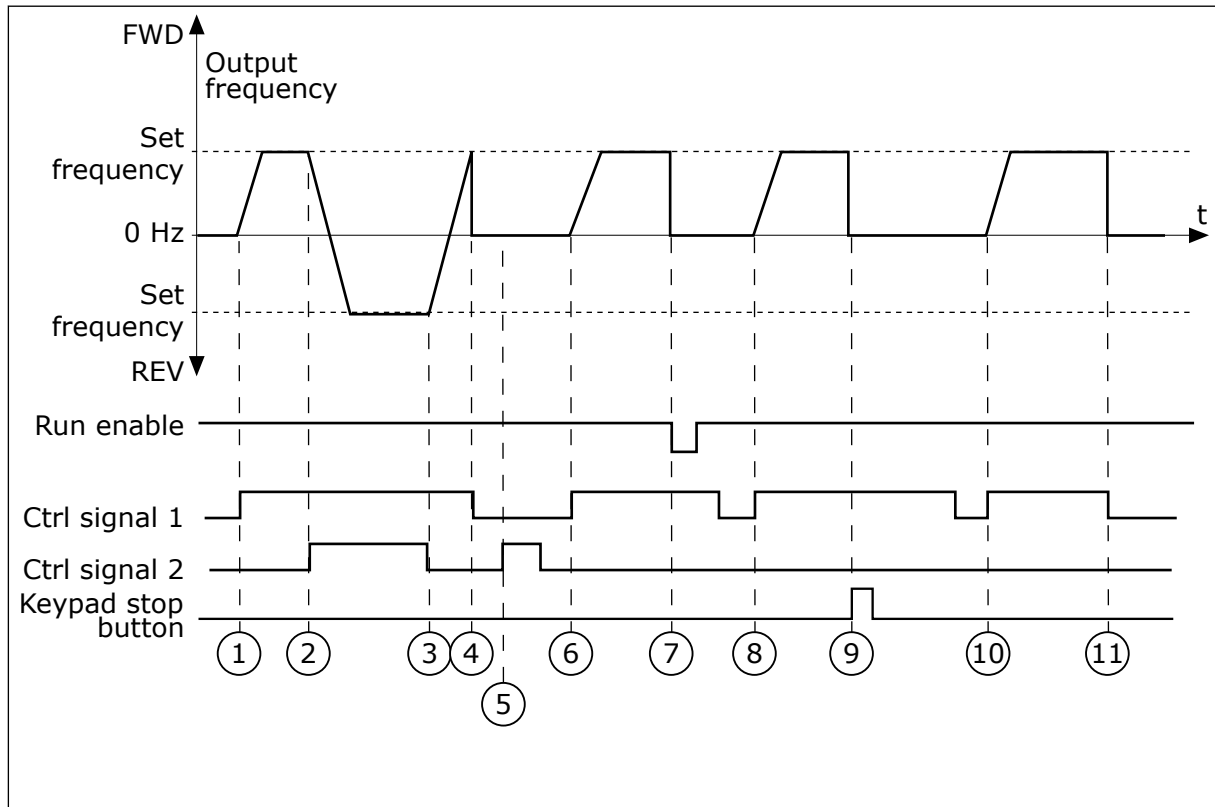

Fig. 47: I/O A Start/stop logic = 4

1. Control signal (CS) 1 activates and causes the output frequency to increase. The motor operates forward because CS2 is inactive.
2. CS2 activates, which causes the direction to start to change (FWD to REV).
3. CS2 becomes inactive, which causes the direction to start to change (REV to FWD), because CS1 is still active.
4. CS1 becomes inactive and the frequency goes to 0.
5. CS2 activates, but the motor does not start because CS1 is inactive.
6. CS1 activates and causes the output frequency to increase again. The motor operates forward, because CS2 is inactive.
7. The Run enable signal is set to OPEN, which causes the frequency to go to 0. Configure the Run enable signal with parameter P3.5.1.15.
8. Before the drive can start, you must open and close CS1 again.

9. The STOP button on the keypad is pushed and the frequency that is fed to the motor goes to 0. (This signal only works if the value of P3.2.3 Keypad Stop Button is Yes.)
10. Before the drive can start, you must open and close CS1 again.
11. CS1 becomes inactive and the frequency goes to 0.

P3.2.7 I/O B START/STOP LOGIC (ID 363)

Use this parameter to control the start and stop of the drive with the digital signals. The selections can include the word 'edge' to help you prevent an accidental start. See P3.2.6 for more information.

P3.2.8 FIELDBUS START LOGIC (ID 889)

Use this parameter to set the fieldbus start logic. The selections can include the word 'edge' to help you prevent an accidental start.

Selection number	Selection name	Description
0	A rising edge is necessary	
1	State	

P3.2.9 START DELAY (ID 524)

Use this parameter to set the delay between the start command and the actual start of the drive.

P3.2.10 REMOTE TO LOCAL FUNCTION (ID 181)

Use this parameter to set the selection of copy settings when you go from Remote to Local (keypad) control.

Selection number	Selection name	Description
0	Keep Run	
1	Keep Run & Reference	
2	Stop	

P3.2.11 RESTART DELAY (ID 15555)

Use this parameter to set the time delay during which the drive cannot be restarted after the drive has been stopped.

The parameter is used in compressor applications.

Selection number	Selection name	Description
0	Restart delay not used	

10.4 REFERENCES

10.4.1 FREQUENCY REFERENCE

It is possible to program the source of the frequency reference in all the control places, except the PC tool. If you use your PC, it always takes the frequency reference from the PC tool.

REMOTE CONTROL PLACE (I/O A)

To set the source of the frequency reference for I/O A, use the parameter P3.3.1.5 .

REMOTE CONTROL PLACE (I/O B)

To set the source of the frequency reference for I/O B, use the parameter P3.3.1.6.

LOCAL CONTROL PLACE (KEYPAD)

If you use the default value *keypad* for the parameter P3.3.1.7, the reference that you set for P3.3.1.8 Keypad Reference applies.

REMOTE CONTROL PLACE (FIELDBUS)

If you keep the default value *fieldbus* for the parameter P3.3.1.10, the frequency reference comes from fieldbus.

P3.3.1.1 MINIMUM FREQUENCY REFERENCE (ID 101)

Use this parameter to set the minimum frequency reference.

P3.3.1.2 MAXIMUM FREQUENCY REFERENCE (ID 102)

Use this parameter to set the maximum frequency reference.

P3.3.1.3 POSITIVE FREQUENCY REFERENCE LIMIT (ID 1285)

Use this parameter to set the final frequency reference limit for the positive direction.

P3.3.1.4 NEGATIVE FREQUENCY REFERENCE LIMIT (ID 1286)

Use this parameter to set the final frequency reference limit for the negative direction. Use this parameter for example to prevent the motor from running in the reverse direction.

P3.3.1.5 I/O CONTROL REFERENCE A SELECTION (ID 117)

Use this parameter to select the reference source when the control place is I/O A. The application that you set with parameter 1.2 gives the default value.

P3.3.1.6 I/O CONTROL REFERENCE B SELECTION (ID 131)

Use this parameter to select the reference source when the control place is I/O B. See P3.3.1.5 for more information. You can force the I/O B control place to be active only with a digital input (P3.5.1.7).

P3.3.1.7 KEYPAD CONTROL REFERENCE SELECTION (ID 121)

Use this parameter to select the reference source when the control place is keypad.

P3.3.1.8 KEYPAD REFERENCE (ID 184)

Use this parameter to adjust the frequency reference on the keypad.

P3.3.1.9 KEYPAD DIRECTION (ID 123)

Use this parameter to set the rotation direction of the motor when the control place is keypad.

P3.3.1.10 FIELDBUS CONTROL REFERENCE SELECTION (ID 122)

Use this parameter to select the reference source when the control place is Fieldbus. The selection of the application with parameter P1.2 Application gives the default value. See the default values in Chapter 12 Appendix 1.

10.4.2 PRESET FREQUENCIES**P3.3.3.1 PRESET FREQUENCY MODE (ID 182)**

Use this parameter to set the logic of the digital input preset frequencies. With this parameter, you can set the logic which one of the preset frequencies is selected into use. There is a selection of 2 different logics. The number of preset speed digital inputs that are active defines the preset frequency.

Selection number	Selection name	Description
0	Binary coded	The mix of the inputs is binary coded. The different sets of active digital inputs determine the preset frequency. See more data in <i>Table 118 The selection of preset frequencies when P3.3.3.1 = Binary coded.</i>
1	Number (of inputs used)	The number of active inputs tells which preset frequency is used: 1, 2 or 3.

P3.3.3.2 PRESET FREQUENCY 0 (ID 180)

Use this parameter to set the preset frequency reference when the preset frequencies function is used. Select the preset frequencies with the digital input signals.

P3.3.3.3 PRESET FREQUENCY 1 (ID 105)

Use this parameter to set the preset frequency reference when the preset frequencies function is used.

Select the preset frequencies with the digital input signals.

P3.3.3.4 PRESET FREQUENCY 2 (ID 106)

Use this parameter to set the preset frequency reference when the preset frequencies function is used.

Select the preset frequencies with the digital input signals.

P3.3.3.5 PRESET FREQUENCY 3 (ID 126)

Use this parameter to set the preset frequency reference when the preset frequencies function is used.

Select the preset frequencies with the digital input signals.

P3.3.3.6 PRESET FREQUENCY 4 (ID 127)

Use this parameter to set the preset frequency reference when the preset frequencies function is used.

Select the preset frequencies with the digital input signals.

P3.3.3.7 PRESET FREQUENCY 5 (ID 128)

Use this parameter to set the preset frequency reference when the preset frequencies function is used.

Select the preset frequencies with the digital input signals.

P3.3.3.8 PRESET FREQUENCY 6 (ID 129)

Use this parameter to set the preset frequency reference when the preset frequencies function is used.

Select the preset frequencies with the digital input signals.

P3.3.3.9 PRESET FREQUENCY 7 (ID 130)

Use this parameter to set the preset frequency reference when the preset frequencies function is used.

Select the preset frequencies with the digital input signals.

VALUE 0 SELECTED FOR PARAMETER P3.3.3.1:

To set Preset Frequency 0 as reference, set the value 0 *Preset Frequency 0* for P3.3.1.5 (I/O Control Reference A Selection).

To make a selection of a preset frequency between 1 and 7, give digital inputs to P3.3.3.10 (Preset Frequency Selection 0), P3.3.3.11 (Preset Frequency Selection 1), and/or P3.3.3.12 (Preset Frequency Selection 2). The different sets of active digital inputs determine the preset frequency. You can find more data in the table below. The values of the preset frequencies stay automatically between the minimum and maximum frequencies (P3.3.1.1 and P3.3.1.2).

Necessary step	Activated frequency
Make a selection of the value 0 for parameter P3.3.1.5.	Preset frequency 0

Table 118: The selection of preset frequencies when P3.3.3.1 = Binary coded

Activated digital input signal			Activated frequency reference
Preset Freq Sel2 (P3.3.3.12)	Preset Freq Sel1 (P3.3.3.11)	Preset Freq Sel0 (P3.3.3.10)	
			Preset frequency 0 Only if Preset Freq 0 is set as frequency reference source with P3.3.3.1.5, P3.3.1.6, P3.3.1.7 or P3.3.1.10.
		*	Preset frequency 1
	*		Preset frequency 2
	*	*	Preset frequency 3
*			Preset frequency 4
*		*	Preset frequency 5
*	*		Preset frequency 6
*	*	*	Preset frequency 7

* = the input is activated.

VALUE 1 SELECTED FOR PARAMETER P3.3.3.1:

You can use the Preset Frequencies 1 to 3 with different sets of active digital inputs. The number of active inputs tells which one is used.

Table 119: The selection of preset frequencies when P3.3.3.1 = Number of inputs

Activated digital input signal			Activated frequency reference
Preset Freq Sel2 (P3.3.3.12)	Preset Freq Sel1 (P3.3.3.11)	Preset Freq Sel0 (P3.3.3.10)	
			Preset frequency 0 Only if Preset Freq 0 is set as frequency reference source with P3.3.3.1.5, P3.3.1.6, P3.3.1.7 or P3.3.1.10.
		*	Preset frequency 1
	*		Preset frequency 1
*			Preset frequency 1
	*	*	Preset frequency 2
*		*	Preset frequency 2
*	*		Preset frequency 2
*	*	*	Preset frequency 3

* = the input is activated.

P3.3.3.10 PRESET FREQUENCY SELECTION 0 (ID 419)

Use this parameter to select the digital input signal that is used as a selector for the preset frequencies.

This parameter is a binary selector for Preset speeds (0-7). See parameters P3.3.3.2 to P3.3.3.9.

P3.3.3.11 PRESET FREQUENCY SELECTION 1 (ID 420)

Use this parameter to select the digital input signal that is used as a selector for the preset frequencies.

This parameter is a binary selector for Preset speeds (0-7). See parameters P3.3.3.2 to P3.3.3.9.

P3.3.3.12 PRESET FREQUENCY SELECTION 2 (ID 421)

Use this parameter to select the digital input signal that is used as a selector for the preset frequencies.

This parameter is a binary selector for Preset speeds (0-7). See parameters P3.3.3.2 to P3.3.3.9.

To apply Preset frequencies 1 to 7, connect a digital input to these functions with the instructions in Chapter 10.6.1 *Programming of digital and analogue inputs*. See more data in Table 118 *The selection of preset frequencies when P3.3.3.1 = Binary coded* and also in Table 35 *Preset frequency parameters* and Table 43 *Digital input settings*.

10.4.3 MOTOR POTENTIOMETER PARAMETERS

The frequency reference of the Motor Potentiometer is available in all the control places. You can change the motor potentiometer reference only when the drive is in the run state.



NOTE!

If you set the output frequency slower than the Motor Potentiometer Ramp Time, the normal acceleration and deceleration times give limits to it.

P3.3.4.1 MOTOR POTENTIOMETER UP (ID 418)

Use this parameter to increase the output frequency with a digital input signal. With a motor potentiometer, you can increase and decrease the output frequency. When you connect a digital input to parameter Motor Potentiometer UP, and have the digital input signal active, the output frequency rises. The motor potentiometer reference INCREASES until the contact is opened.

P3.3.4.2 MOTOR POTENTIOMETER DOWN (ID 417)

Use this parameter to decrease the output frequency with a digital input signal. With a motor potentiometer, you can increase and decrease the output frequency. When you connect a digital input to parameter Motor Potentiometer DOWN, and have the digital input signal active, the output frequency falls. The motor potentiometer reference DECREASES until the contact is opened.

3 different parameters have an effect on how the output frequency rises or falls when Motor Potentiometer UP or DOWN is active. These parameters are Motor Potentiometer Ramp Time (P3.3.4.3), Acceleration Time (P3.4.1.2), and Deceleration Time (P3.4.1.3).

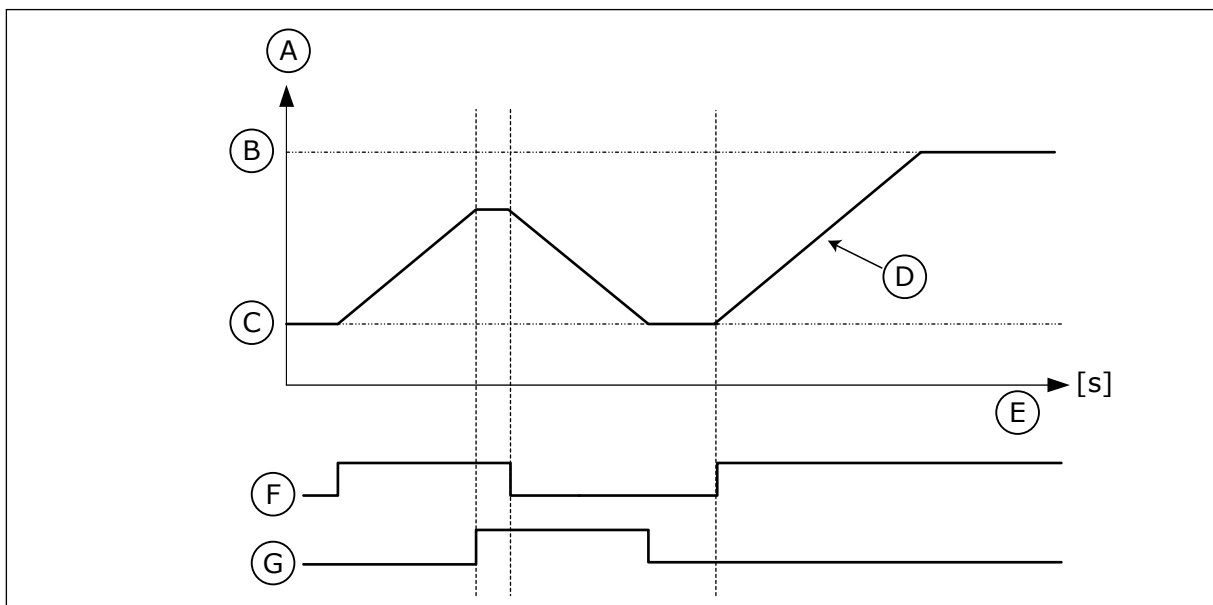

Fig. 48: The motor potentiometer parameters

- | | |
|------------------------|----------------------------------|
| A. Frequency Reference | D. Motor potentiometer ramp time |
| B. Max Frequency | E. Time |
| C. Min Frequency | F. Motor potentiometer UP |
| | G. Motor potentiometer DOWN |

P3.3.4.3 MOTOR POTENTIOMETER RAMP TIME (ID 331)

Use this parameter to set the rate of change in the motor potentiometer reference when it is increased or decreased.

The parameter value is entered as Hz/second.

P3.3.4.4 MOTOR POTENTIOMETER RESET (ID 367)

Use this parameter to set the logic for the resetting of the frequency reference of the motor potentiometer.

This parameter defines when the reference of the motor potentiometer is set to 0.

There are 3 selections in the reset function: no reset, reset when the drive stops, or reset when the drive is powered down.

Selection number	Selection name	Description
0	No reset	The last motor potentiometer frequency reference is kept through the stop state and kept in memory if a powerdown occurs.
1	Stop state	The motor potentiometer frequency reference is set to 0 when the drive goes to the stop state, or when the drive is powered down.
2	Powered down	The motor potentiometer frequency reference is set to 0 only when a powerdown occurs.

10.4.4 FLUSHING PARAMETERS

Use the Flushing function to momentarily override the normal control. With the function you can flush the pipeline or operate the pump manually at the preset constant speed, for example.

The Flushing function starts the drive at a selected reference without a start command no matter the control place.

P3.3.6.1 FLUSHING REFERENCE ACTIVATION (ID 530)

Use this parameter to select the digital input signal that activates the Flushing function. The flushing frequency reference is bidirectional and a reverse command does not have an effect on the direction of the flushing reference.

**NOTE!**

When you activate the digital input, the drive starts.

P3.3.6.2 FLUSHING REFERENCE (ID 1239)

Use this parameter to set the frequency reference of the drive when the Flushing function is used.

The reference is bidirectional and a reverse command does not have an effect on the direction of the flushing reference. The reference for the forward direction is specified as a positive value and the reverse direction is specified as a negative value.

10.5 RAMPS AND BRAKES SETUP

10.5.1 RAMP 1

P3.4.1.1 RAMP 1 SHAPE (ID 500)

Use this parameter to make the start and the end of the acceleration and deceleration ramps smoother.

With the parameters Ramp 1 Shape and Ramp 2 Shape, you can make smoother the start and the end of the acceleration and deceleration ramps. If you set the value to 0.0%, you get a linear ramp shape. The acceleration and deceleration act immediately to the changes in the reference signal.

When you set the value between 1.0% and 100.0%, you get an S-shaped acceleration or deceleration ramp. Use this function to reduce mechanical erosion of the parts and current spikes when the reference changes. You can modify the acceleration time with parameters P3.4.1.2 (Acceleration Time 1) and P3.4.1.3 (Deceleration Time 1).

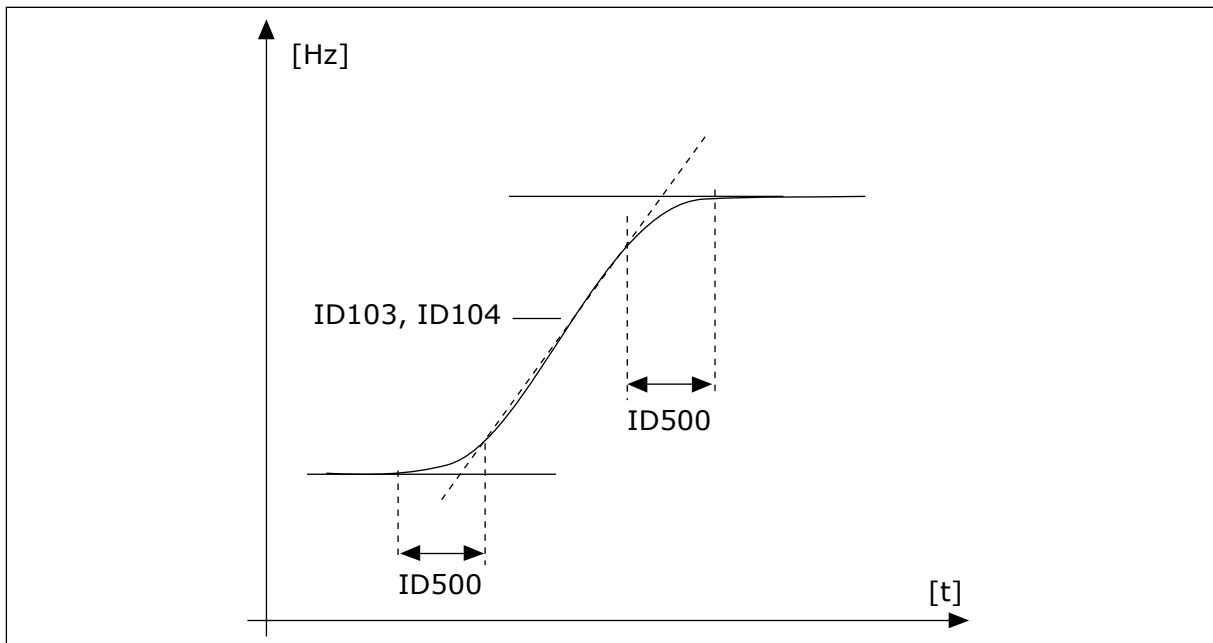

Fig. 49: The acceleration/deceleration curve (S-shaped)

P3.4.1.2 ACCELERATION TIME 1 (ID 103)

Use this parameter to set the time that is necessary for the output frequency to increase from zero frequency to maximum frequency.

P3.4.1.3 DECELERATION TIME 1 (ID 104)

Use this parameter to set the time that is necessary for the output frequency to decrease from maximum frequency to zero frequency.

10.5.2 RAMP 2

P3.4.2.1 RAMP 2 SHAPE (ID 501)

Use this parameter to make the start and the end of the acceleration and deceleration ramps smoother.

With the parameters Ramp 1 Shape and Ramp 2 Shape, you can make smoother the start and the end of the acceleration and deceleration ramps. If you set the value to 0.0%, you get a linear ramp shape. The acceleration and deceleration act immediately to the changes in the reference signal.

When you set the value between 1.0% and 100.0%, you get an S-shaped acceleration or deceleration ramp. Use this function to reduce mechanical erosion of the parts and current spikes when the reference changes. You can modify the acceleration time with parameters P3.4.2.2 (Acceleration Time 2) and P3.4.2.3 (Deceleration Time 2).

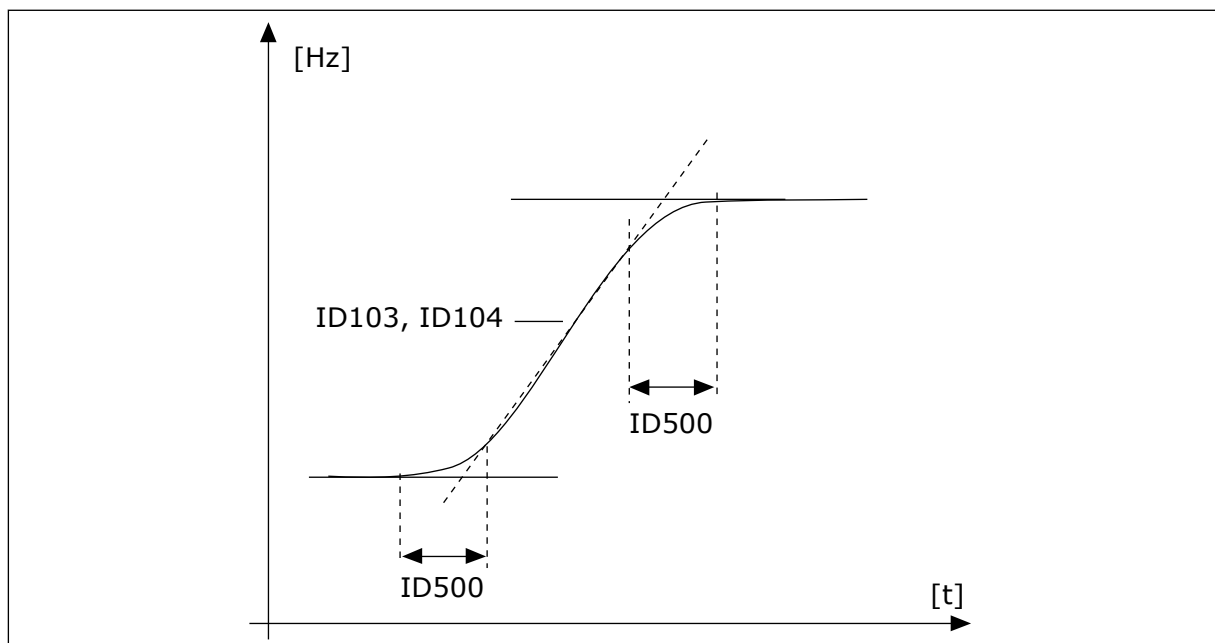

Fig. 50: The acceleration/deceleration curve (S-shaped)

P3.4.2.2 ACCELERATION TIME 2 (ID 502)

Use this parameter to set the time that is necessary for the output frequency to increase from zero frequency to maximum frequency.

P3.4.2.3 DECELERATION TIME 2 (ID 503)

Use this parameter to set the time that is necessary for the output frequency to decrease from maximum frequency to zero frequency.

P3.4.2.4 RAMP 2 SELECTION (ID 408)

Use this parameter to select either ramp 1 or ramp 2.

Selection number	Selection name	Description
0	OPEN	Ramp 1 Shape, Acceleration Time 1 and Deceleration Time 1
1	CLOSED	Ramp 2 Shape, Acceleration Time 2 and Deceleration Time 2

P3.4.2.5 RAMP 2 THRESHOLD FREQUENCY (ID 533)

Use this parameter to set the output frequency limit above which the Ramp 2 is used.

Use the function, for example, in applications for deep well pumps, where faster ramp times are necessary when the pump starts or stops (operates below the minimum frequency).

Second ramp times are activated when the output frequency of the drive goes above the limit specified by this parameter. To disable the function, set the value of the parameter to 0.

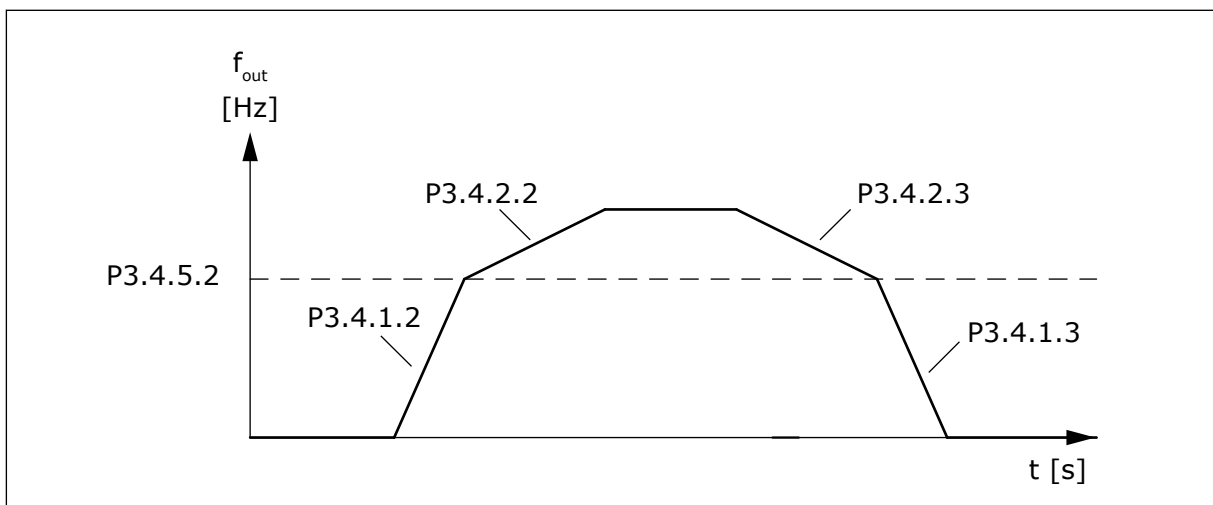

Fig. 51: Ramp 2 activation when the output frequency goes above the threshold level. (P.3.4.5.2 = Ramp threshold freq., P3.4.1.2 = Acc. time 1, P3.4.2.2 = Acc. time 2, P3.4.1.3 = Dec. time 1, P3.4.2.3 = Dec. time 2)

10.5.3 START MAGNETISING

P3.4.3.1 START MAGNETISING CURRENT (ID 517)

Use this parameter to set the DC current that is fed into the motor at the start. If the value of this parameter is set to 0, the Start Magnetising function is disabled.

P3.4.3.2 START MAGNETISING TIME (ID 516)

Use this parameter to set the time during which the DC current is fed to the motor before the acceleration starts.

10.5.4 DC BRAKE

P3.4.4.1 DC BRAKE CURRENT (ID 507)

Use this parameter to set the current that is fed into the motor during DC braking. If the value of this parameter is set to 0, the DC Brake function is disabled.

P3.4.4.2 DC BRAKING TIME AT STOP (ID 508)

Use this parameter to set the braking is ON or OFF and to give the braking time when the motor stops.

If the value of this parameter is set to 0, the DC Brake function is disabled.

P3.4.4.3 FREQUENCY TO START DC BRAKING AT RAMP STOP (ID 515)

Use this parameter to set the output frequency at which the DC braking starts.

10.5.5 FLUX BRAKING

P3.4.5.1 FLUX BRAKING (ID 520)

Use this parameter to enable Flux Braking.

You can use flux braking as an alternative to DC braking. Flux braking increases the braking capacity in conditions where additional brake resistors are not necessary.

When braking is necessary, the system decreases the frequency and increases the flux in the motor. This increases the capacity of the motor to brake. The motor speed is controlled during braking.



CAUTION!

Use the braking only intermittently. Flux braking converts energy into heat and can cause damage to the motor.

P3.4.5.2 FLUX BRAKING CURRENT (ID 519)

Use this parameter to set the current level for the flux braking.

10.6 I/O CONFIGURATION

10.6.1 PROGRAMMING OF DIGITAL AND ANALOGUE INPUTS

The programming of inputs of the AC drive is flexible. You can freely use the available inputs of the standard and optional I/O for different functions.

It is possible to expand the available capacity of I/O with option boards. You can install the option boards in the slots C, D and E. You can find more data on the installation of option boards in the Installation manual.

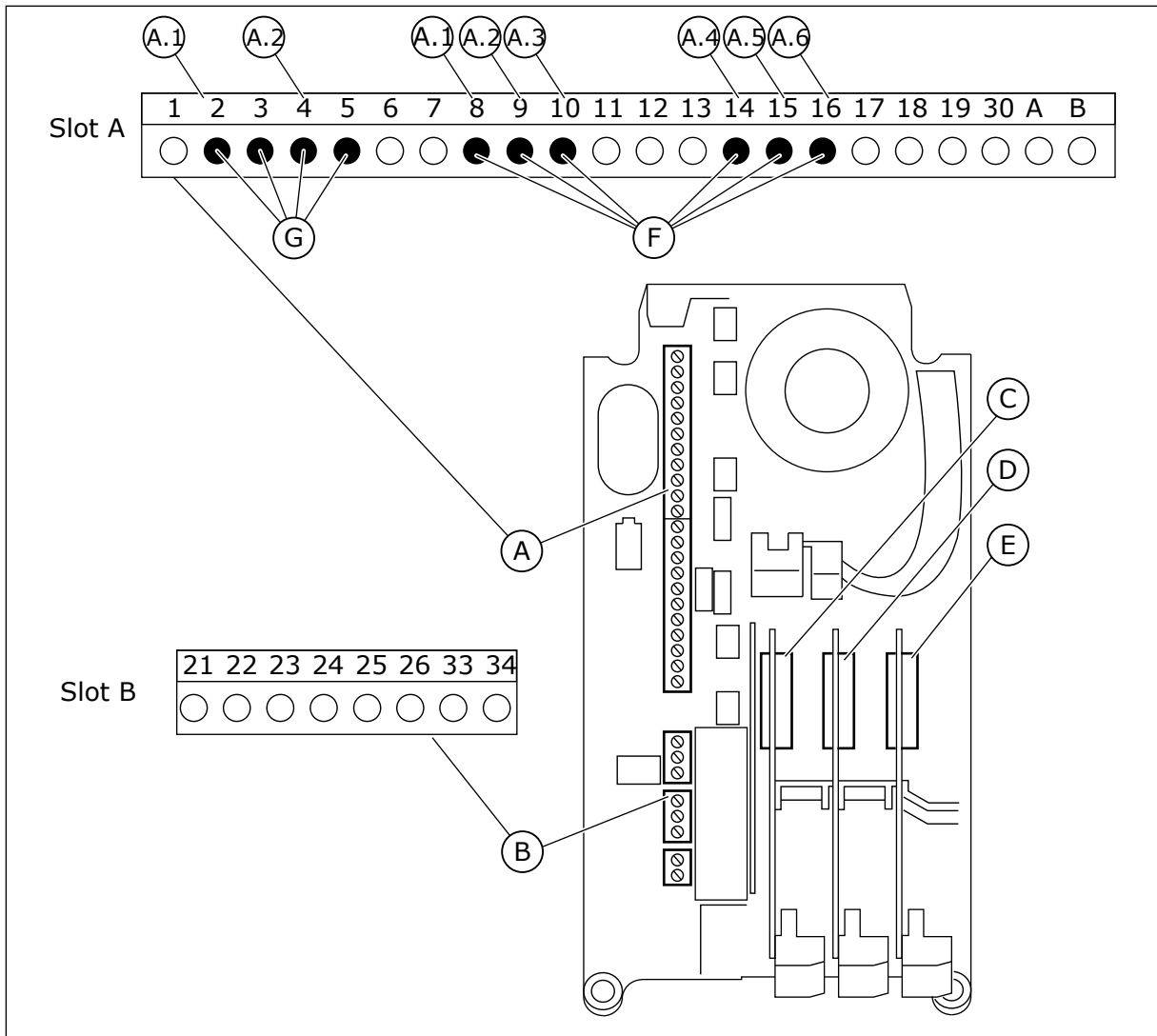

Fig. 52: The option board slots and programmable inputs

- A. Standard board slot A and its terminals
- B. Standard board slot B and its terminals
- C. Option board slot C
- D. Option board slot D
- E. Option board slot E
- F. Programmable digital inputs (DI)
- G. Programmable analogue inputs (AI)

10.6.1.1 Programming of digital inputs

You can find the applicable functions for digital inputs as parameters in parameter group M3.5.1. To give a digital input to a function, set a value to the correct parameter. The list of applicable functions shows in *Table 43 Digital input settings*.

Example

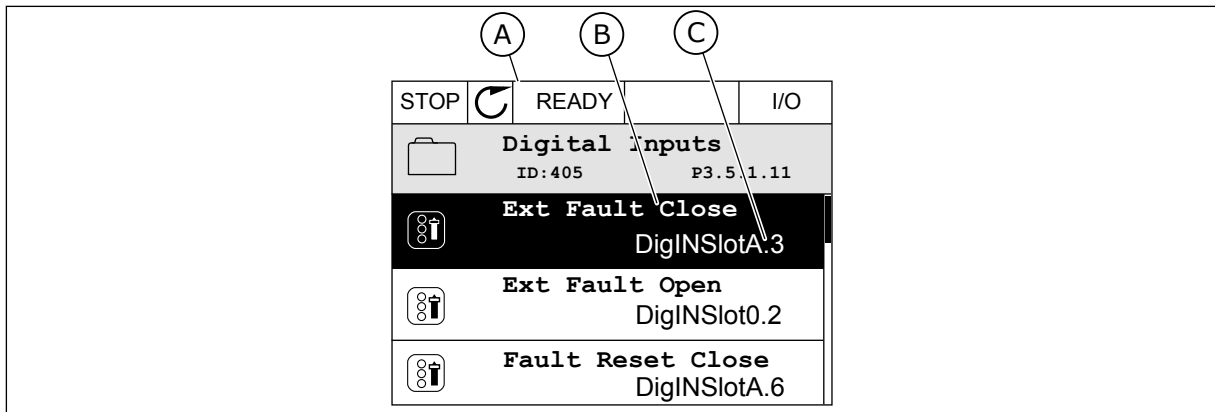

Fig. 53: The Digital inputs menu in the graphical display

- A. The graphical display
- B. The name of the parameter, that is, the function
- C. The value of the parameter, that is, the set digital input

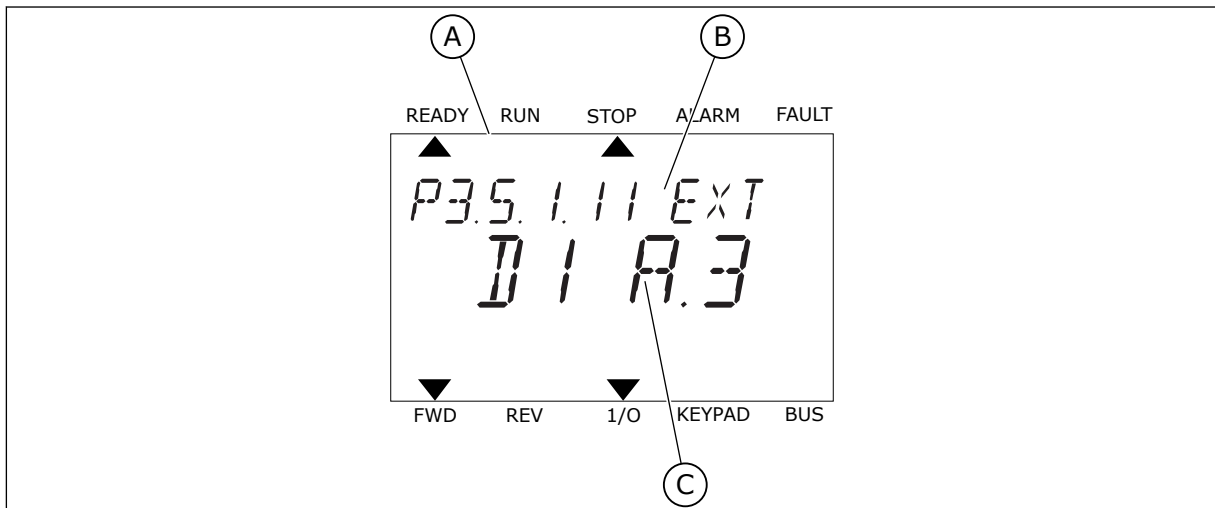

Fig. 54: The Digital inputs menu in the text display

- A. The text display
- B. The name of the parameter, that is, the function
- C. The value of the parameter, that is, the set digital input

In the standard I/O board compilation, there are 6 digital inputs available: the slot A terminals 8, 9, 10, 14, 15 and 16.

Input type (graphical display)	Input type (text display)	Slot	Input #	Explanation
DigIN	dl	A	1	Digital input #1 (terminal 8) on a board in Slot A (standard I/O board).
DigIN	dl	A	2	Digital input #2 (terminal 9) on a board in Slot A (standard I/O board).
DigIN	dl	A	3	Digital input #3 (terminal 10) on a board in Slot A (standard I/O board).
DigIN	dl	A	4	Digital input #4 (terminal 14) on a board in Slot A (standard I/O board).
DigIN	dl	A	5	Digital input #5 (terminal 15) on a board in Slot A (standard I/O board).
DigIN	dl	A	6	Digital input #6 (terminal 16) on a board in Slot A (standard I/O board).

The function External Fault Close, the location of which is the menu M3.5.1, is parameter P3.5.1.11. It gets the default value DigIN SlotA.3 in the graphical display, and dl A.3 in the text display. After this selection, a digital signal to the digital input DI3 (terminal 10) controls External Fault Close.

Index	Parameter	Default	ID	Description
P3.5.1.11	External fault close	DigIN SlotA.3	405	OPEN = OK CLOSED = External fault

To change the input from DI3 to, for example, DI6 (terminal 16) on the standard I/O, obey these instructions.

PROGRAMMING IN THE GRAPHICAL DISPLAY

- 1 Make a selection of a parameter. To go into the Edit mode, push the arrow button Right.

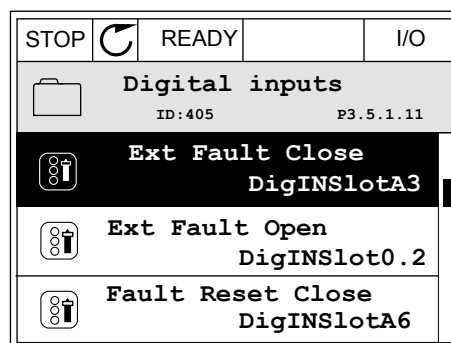

- In the Edit mode, the slot value DigIN SlotA is underlined and blinks. If you have more digital inputs available in your I/O, for example, because of option boards in slots C, D or E, make a selection of them.

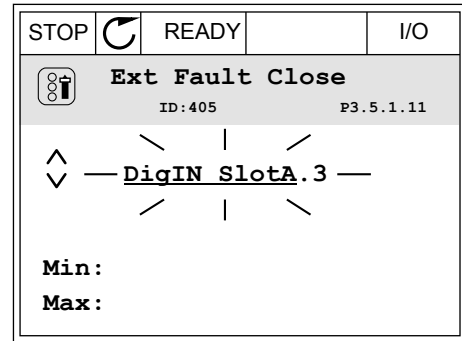

- To activate the terminal 3, push the arrow button Right again.

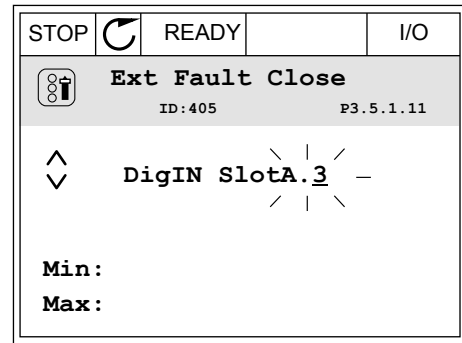

- To change the terminal to 6, push the arrow button Up 3 times. Accept the change with the OK button.

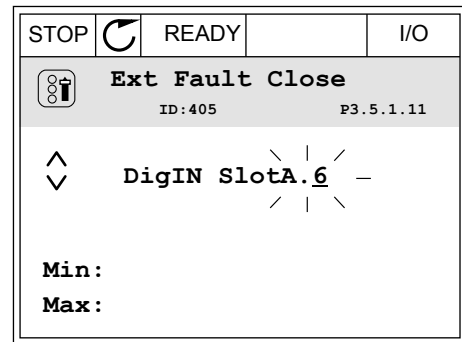

- If the digital input DI6 was already used for some other function, a message shows on the display. Change one of these selections.

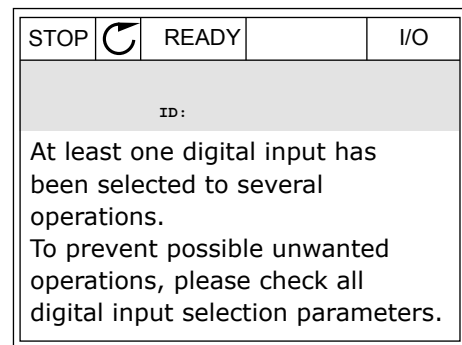

PROGRAMMING IN THE TEXT DISPLAY

- 1 Make a selection of a parameter. To go into the Edit mode, push the OK button.

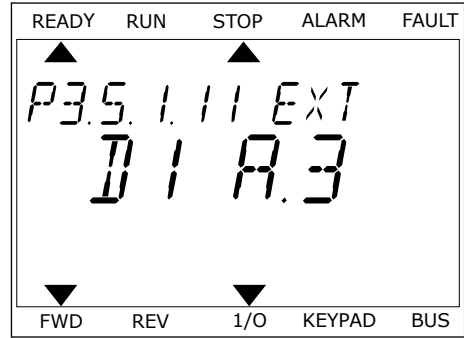

- 2 In the Edit mode, the letter D blinks. If you have more digital inputs available in your I/O, for example, because of option boards in slots C, D or E, make a selection of them.

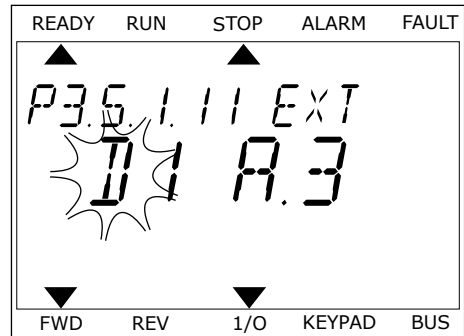

- 3 To activate the terminal 3, push the arrow button Right again. The letter D stops blinking.

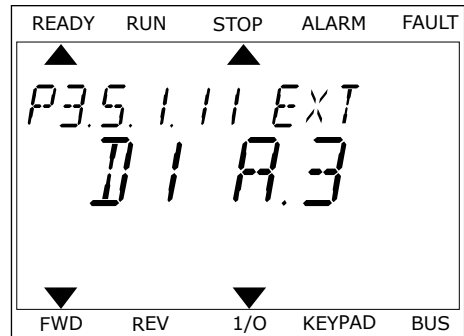

- 4 To change the terminal to 6, push the arrow button Up 3 times. Accept the change with the OK button.

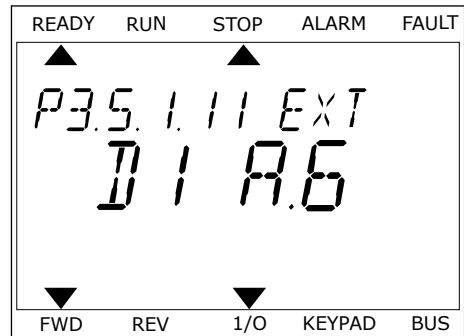

- 5 If the digital input DI6 was already used for some other function, a message scrolls on the display. Change one of these selections.

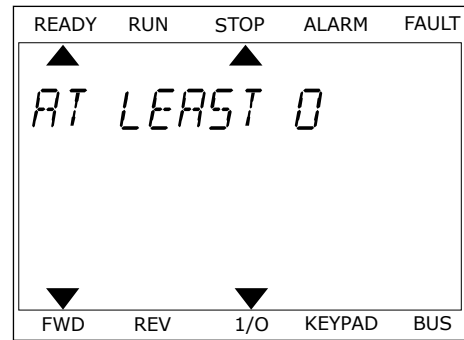

After the steps, a digital signal to the digital input DI6 controls the function External Fault Close.

The value of a function can be DigIN Slot0.1 (in the graphical display) or dl 0.1 (in the text display). In these conditions, you did not give a terminal to the function, or the the input was set to be always OPEN. This is the default value of most of parameters in the group M3.5.1. On the other hand, some inputs have the default value always CLOSED. Their value shows DigIN Slot0.2 in the graphical display and dl 0.2 in the text display.



NOTE!

You can also give time channels to digital inputs. There is more data about it in 12.1 *The default values of parameters in the different applications.*

10.6.1.2 Programming of analogue inputs

You can make a selection of the target input for the signal of the analogue frequency reference from the available analogue inputs.

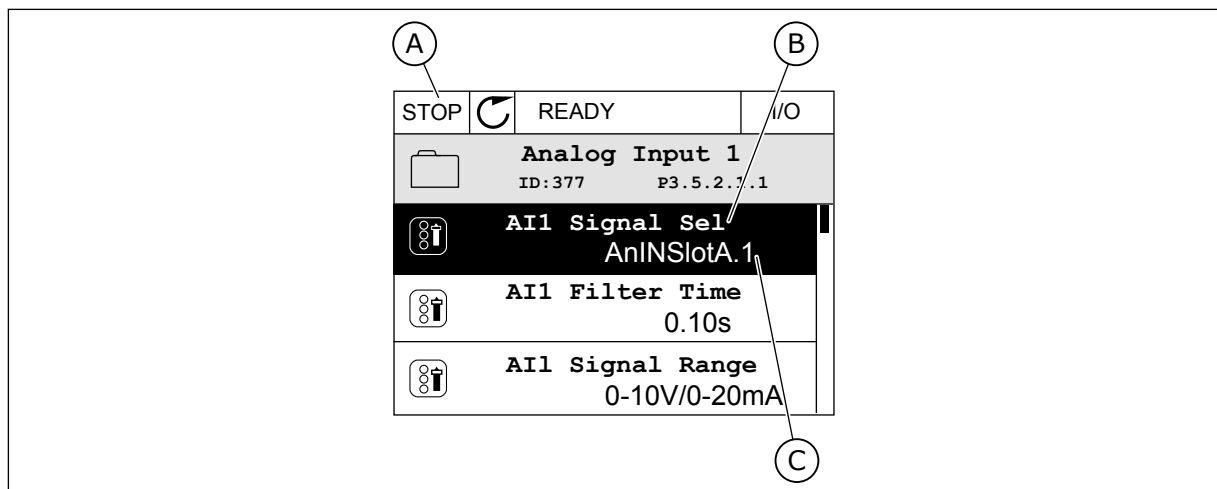

Fig. 55: The Analogue inputs menu in the graphical display

- A. The graphical display
- B. The name of the parameter
- C. The value of the parameter, that is, the set analogue input

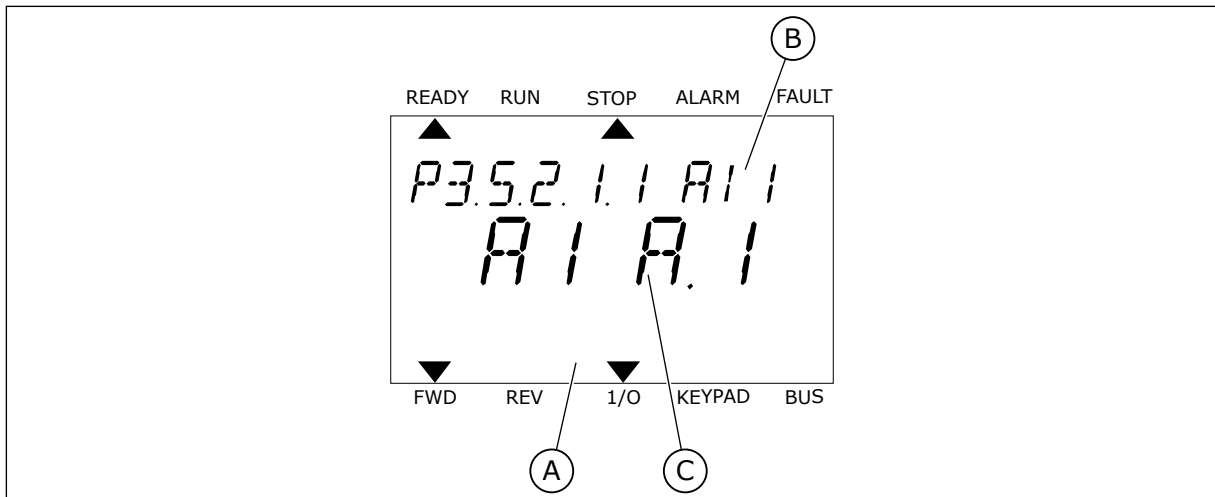

Fig. 56: The Analogue inputs menu in the text display

- A. The text display
- B. The name of the parameter
- C. The value of the parameter, that is, the set analogue input

In the standard I/O board compilation, there are 2 analogue inputs available: the slot A terminals 2/3 and 4/5.

Input type (graphical display)	Input type (text display)	Slot	Input #	Explanation
AnIN	AI	A	1	Analogue input #1 (terminals 2/3) on a board in Slot A (standard I/O board).
AnIN	AI	A	2	Analogue input #2 (terminals 4/5) on a board in Slot A (standard I/O board).

The location of the parameter P3.5.2.1.1 AI1 Signal Selection is the menu M3.5.2.1. The parameter gets the default value AnIN SlotA.1 in the graphical display or AI A.1 in the text display. The target input for the signal of the analogue frequency reference AI1 is then the analogue input in the terminals 2/3. Use the dip switches to set the signal to be voltage or current. See the Installation manual for more data.

Index	Parameter	Default	ID	Description
P3.5.2.1.1	AI1 Signal Selection	AnIN SlotA.1	377	

To change the input from AI1 to, for example, the analogue input on your option board in slot C, obey these instructions.

PROGRAMMING OF ANALOGUE INPUTS IN THE GRAPHICAL DISPLAY

- 1 To make a selection of the parameter, push the arrow button Right.

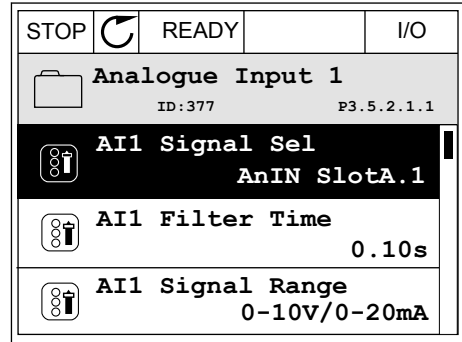

- 2 In the Edit mode, the value AnIN SlotA is underlined and blinks.

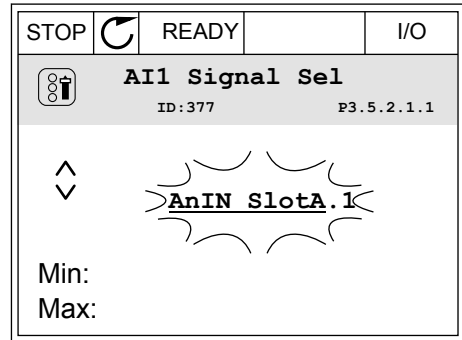

- 3 To change the value to AnIN SlotC, push the arrow button Up. Accept the change with the OK button.

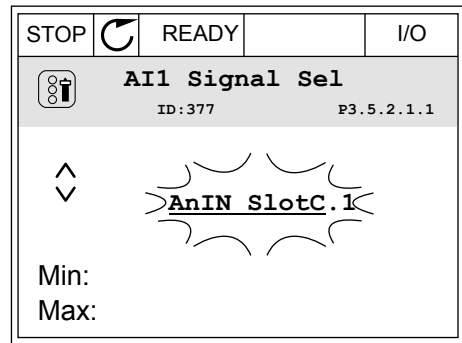

PROGRAMMING OF ANALOGUE INPUTS IN THE TEXT DISPLAY

- 1 To make a selection of the parameter, push the OK button.

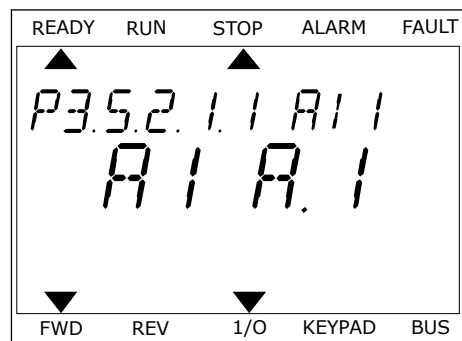

- 2 In the Edit mode, the letter A blinks.

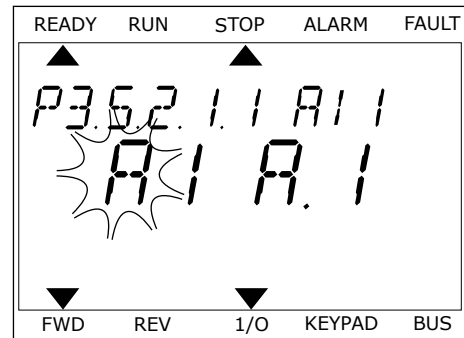

- 3 To change the value to C, push the arrow button Up. Accept the change with the OK button.

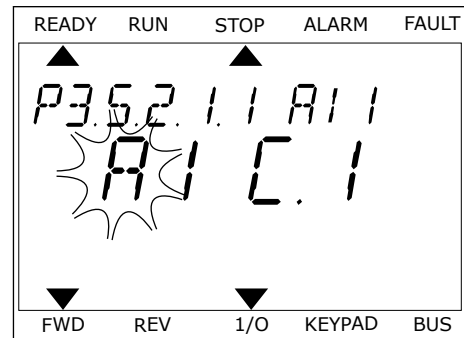

10.6.1.3 Descriptions of signal sources

Source	Function
Slot0.#	<p>Digital inputs:</p> <p>You can use this function to set a digital signal to be in a constant OPEN or CLOSED state. The manufacturer set some signals so that they are always in the CLOSED state, for example parameter P3.5.1.15 (Run Enable). The Run Enable signal is always on if you do not change it.</p> <p># = 1: Always OPEN # = 2-10: Always CLOSED</p> <p>Analogue inputs (used for test purposes):</p> <p># = 1: Analogue input = 0% of the signal strength # = 2: Analogue input = 20% of the signal strength # = 3: Analogue input = 30% of the signal strength etc. # = 10: Analogue input = 100% of the signal strength</p>
SlotA.#	Number (#) agrees to a digital input in slot A.
SlotB.#	Number (#) agrees to a digital input in slot B.
SlotC.#	Number (#) agrees to a digital input in slot C.
SlotD.#	Number (#) agrees to a digital input in slot D.
SlotE.#	Number (#) agrees to a digital input in slot E.
TimeChannel.#	1=Time Channel1, 2=Time Channel2, 3=Time Channel3
FieldbusCW.#	Number (#) refers to a control word bit number.
FieldbusPD.#	Number (#) refers to the process data 1 bit number.

10.6.2 DEFAULT FUNCTIONS OF PROGRAMMABLE INPUTS

Table 120: Default functions of the programmable digital and analogue inputs

Input	Terminal(s)	Reference	Function	Parameter index
DI1	8	A.1	Control Signal 1 A	P3.5.1.1
DI2	9	A.2	Control Signal 2 A	P3.5.1.2
DI3	10	A.3	External Fault Close	P3.5.1.11
DI4	14	A.4	Preset Frequency Selection 0	P3.5.1.21
DI5	15	A.5	Preset Frequency Selection 1	P3.5.1.22
DI6	16	A.6	Fault Reset Close	P3.5.1.13
AI1	2/3	A.1	AI1 Signal Selection	P3.5.2.1.1
AI2	4/5	A.2	AI2 Signal Selection	P3.5.2.2.1

10.6.3 DIGITAL INPUTS

The parameters are functions that you can connect to a digital input terminal. The text *DigIn Slot A.2* means the second input on the slot A. It is also possible to connect the functions to time channels. The time channels work as terminals.

You can monitor the statuses of the digital inputs and the digital outputs in the Multimonitoring view.

P3.5.1.1 CONTROL SIGNAL 1 A (ID 403)

Use this parameter to select the digital input signal (Control Signal 1) that starts and stops the drive when the control place is I/O A (FWD).

P3.5.1.2 CONTROL SIGNAL 2 A (ID 404)

Use this parameter to select the digital input signal (Control Signal 2) that starts and stops the drive when the control place is I/O A (REV).

P3.5.1.3 CONTROL SIGNAL 3 A (ID 434)

Use this parameter to select the digital input signal (Control Signal 3) that starts and stops the drive when the control place is I/O A.

P3.5.1.4 CONTROL SIGNAL 1 B (ID 423)

Use this parameter to select the digital input signal (Control Signal 1) that starts and stops the drive when the control place is I/O B.

P3.5.1.5 CONTROL SIGNAL 2 B (ID 424)

Use this parameter to select the digital input signal (Control Signal 2) that starts and stops the drive when the control place is I/O B.

P3.5.1.6 CONTROL SIGNAL 3 B (ID 435)

Use this parameter to select the digital input signal (Control Signal 3) that starts and stops the drive when the control place is I/O B.

P3.5.1.7 I/O B CONTROL FORCE (ID 425)

Use this parameter to select the digital input signal that switches the control place from I/O A to I/O B.

P3.5.1.8 I/O B REFERENCE FORCE (ID 343)

Use this parameter to select the digital input signal that switches the frequency reference source from I/O A to I/O B.

P3.5.1.9 FIELDBUS CONTROL FORCE (ID 411)

Use this parameter to select the digital input signal that switches the control place and the frequency reference source to Fieldbus (from I/O A, I/O B or Local control).

P3.5.1.10 KEYPAD CONTROL FORCE (ID 410)

Use this parameter to select the digital input signal that switches the control place and the frequency reference source to Keypad (from any control place).

P3.5.1.11 EXTERNAL FAULT CLOSE (ID 405)

Use this parameter to select the digital input signal that activates an external fault.

P3.5.1.12 EXTERNAL FAULT OPEN (ID 406)

Use this parameter to select the digital input signal that activates an external fault.

P3.5.1.13 FAULT RESET CLOSE (ID 414)

Use this parameter to select the digital input signal that resets all active faults. Active faults are reset when the state of the digital input changes from open to closed (rising edge).

P3.5.1.14 FAULT RESET OPEN (ID 213)

Use this parameter to select the digital input signal that resets all active faults. Active faults are reset when the state of the digital input changes from closed to open (falling edge).

P3.5.1.15 RUN ENABLE (ID 407)

Use this parameter to select the digital input signal that sets the drive to Ready state.

When the contact is OPEN, the start of the motor is disabled.
When the contact is CLOSED, the start of the motor is enabled.

To stop, the drive obeys the value of P3.2.5 Stop Function.

P3.5.1.16 RUN INTERLOCK 1 (ID 1041)

Use this parameter to select the digital input signal that prevents to start the drive.
The drive can be ready but start is not possible when the state of the interlock signal is 'open' (damper interlock).

P3.5.1.17 RUN INTERLOCK 2 (ID 1042)

Use this parameter to select the digital input signal that prevents to start the drive.
The drive can be ready but start is not possible when the state of the interlock signal is 'open' (damper interlock).

If an interlock is active, the drive cannot start.

You can use this function to prevent the start of the drive when the damper is closed. If you activate an interlock during the operation of the drive, the drive stops.

P3.5.1.18 MOTOR PREHEAT ON (ID 1044)

Use this parameter to select the digital input signal that activates Motor Preheat function.
The Motor Preheat function feeds DC-current to the motor when the drive is in the stop state.

P3.5.1.19 RAMP 2 SELECTION (ID 408)

Use this parameter to select the digital input signal that selects the ramp time to be used.

P3.5.1.20 ACC/DEC PROHIBIT (ID 415)

Use this parameter to select the digital input signal that prevents the acceleration and the deceleration of the drive.
No acceleration or deceleration is possible until the contact is open.

P3.5.1.21 PRESET FREQUENCY SELECTION 0 (ID 419)

Use this parameter to set the digital input signal that selects the preset frequencies.

P3.5.1.22 PRESET FREQUENCY SELECTION 1 (ID 420)

Use this parameter to set the digital input signal that selects the preset frequencies.

P3.5.1.23 PRESET FREQUENCY SELECTION 2 (ID 421)

Use this parameter to set the digital input signal that selects the preset frequencies.

P3.5.1.24 MOTOR POTENTIOMETER UP (ID 418)

Use this parameter to increase the output frequency with a digital input signal.
The motor potentiometer reference INCREASES until the contact is open.

P3.5.1.25 MOTOR POTENTIOMETER DOWN (ID 417)

Use this parameter to decrease the output frequency with a digital input signal. The motor potentiometer reference DECREASES until the contact is open.

P3.5.1.26 QUICK STOP ACTIVATION (ID 1213)

Use this parameter to select the digital input signal that activates a Quick Stop function. The Quick Stop function stops the drive regardless of the control place or the state of the control signals.

P3.5.1.27 TIMER 1 (ID 447)

Use this parameter to select the digital input signal that starts the timer. The timer starts when this signal is deactivated (falling edge). The output is deactivated when the time defined in the duration parameter has elapsed.

P3.5.1.28 TIMER 2 (ID 448)

Use this parameter to select the digital input signal that starts the timer. The timer starts when this signal is deactivated (falling edge). The output is deactivated when the time defined in the duration parameter has elapsed.

P3.5.1.29 TIMER 3 (ID 449)

Use this parameter to select the digital input signal that starts the timer. The timer starts when this signal is deactivated (falling edge). The output is deactivated when the time defined in the duration parameter has elapsed.

P3.5.1.30 PID SETPOINT BOOST (ID 1046)

Use this parameter to select the digital input signal that activates the boost for the PID setpoint value. The timer starts when this signal is deactivated (falling edge). The output is deactivated when the time defined in the duration parameter has elapsed.

P3.5.1.31 PID SETPOINT SELECTION (ID 1047)

Use this parameter to set the digital input signal that selects the PID setpoint value to be used.

P3.5.1.32 EXTERNAL PID START SIGNAL (ID 1049)

Use this parameter to select the digital input signal that starts and stops the external PID controller.

**NOTE!**

This parameter has no effect if the external PID controller is not enabled in Group 3.14.

P3.5.1.33 EXTERNAL PID SETPOINT SELECTION (ID 1048)

Use this parameter to set the digital input signal that selects the PID setpoint value to be used.

P3.5.1.34 RESET MAINTENANCE COUNTER 1 (ID 490)

Use this parameter to select the digital input that reset the value of the Maintenance Counter.

P3.5.1.36 FLUSHING REFERENCE ACTIVATION (ID 530)

Use this parameter to select the digital input signal that activates the Flushing function. The flushing frequency reference is bidirectional and a reverse command does not have an effect on the direction of the flushing reference.

**NOTE!**

When you activate the digital input, the drive starts.

P3.5.1.38 FIRE MODE ACTIVATION OPEN (ID 1596)

Use this parameter to select the digital input signal that activates the Fire Mode function.

P3.5.1.39 FIRE MODE ACTIVATION CLOSE (ID 1619)

Use this parameter to select the digital input signal that activates the Fire Mode function.

P3.5.1.40 FIRE MODE REVERSE (ID 1618)

Use this parameter to select the digital input signal that gives a command for reverse rotation direction during the Fire Mode. This function has no effect in normal operation.

P3.5.1.41 AUTO-CLEANING ACTIVATION (ID 1715)

Use this parameter to select the digital input signal that starts the Auto-cleaning sequence. The Auto-cleaning stops if the activation signal is removed before the process is complete.

**NOTE!**

If the input is activated, the drive starts.

P3.5.1.42 PUMP 1 INTERLOCK (ID 426)

Use this parameter to select the digital input signal that is used as interlock signal for the Multi-pump system. The selection of the application with parameter P1.2 Application gives the default value.

P3.5.1.43 PUMP 2 INTERLOCK (ID 427)

Use this parameter to select the digital input signal that is used as interlock signal for the Multi-pump system.

The selection of the application with parameter P1.2 Application gives the default value.

P3.5.1.44 PUMP 3 INTERLOCK (ID 428)

Use this parameter to select the digital input signal that is used as interlock signal for the Multi-pump system.

The selection of the application with parameter P1.2 Application gives the default value.

P3.5.1.45 PUMP 4 INTERLOCK (ID 429)

Use this parameter to select the digital input signal that is used as interlock signal for the Multi-pump system.

P3.5.1.46 PUMP 5 INTERLOCK (ID 430)

Use this parameter to select the digital input signal that is used as interlock signal for the Multi-pump system.

P3.5.1.47 PUMP 6 INTERLOCK (ID 486)

Use this parameter to select the digital input signal that is used as interlock signal for the Multi-pump system.

P3.5.1.48 PUMP 7 INTERLOCK (ID 487)

Use this parameter to select the digital input signal that is used as interlock signal for the Multi-pump system.

P3.5.1.49 PUMP 8 INTERLOCK (ID 488)

Use this parameter to select the digital input signal that is used as interlock signal for the Multi-pump system.

P3.5.1.52 RESET KWH TRIP COUNTER (ID 1053)

Use this parameter to select the digital input signal that resets the kWh Trip Counter.

P3.5.1.53 PARAMETER SET 1/2 SELECTION (ID 496)

The parameter gives the digital input which is used to select Parameter Set 1 or Set 2. The function is enabled if other slots than *DigIN Slot0* are selected to this parameter. The selection of the parameter set can be made and the set changes only when the drive is stopped.

- Contact Open = Parameter Set 1 is set as the active set
- Contact Closed = Parameter Set 2 is set as the active set



NOTE!

Parameter values are stored to Set 1 and Set 2 with parameters B6.5.4 Save to Set 1 and B6.5.4 Save to Set 2. You can use these parameters with the keypad or the PC tool VACON® Live.

P3.5.1.54 MULTI-SETPOINT SELECTION 0 (ID 15576)

Use this parameter to select the digital input signal that is used as a selector for the PID Multi-setpoint function.

P3.5.1.55 MULTI-SETPOINT SELECTION 1 (ID 15577)

Use this parameter to select the digital input signal that is used as a selector for the PID Multi-setpoint function.

P3.5.1.56 MULTI-SETPOINT SELECTION 2 (ID 15578)

Use this parameter to select the digital input signal that is used as a selector for the PID Multi-setpoint function.

P3.5.1.57 MULTI-SETPOINT SELECTION 3 (ID 15579)

Use this parameter to select the digital input signal that is used as a selector for the PID Multi-setpoint function.

P3.5.1.58 FLOW SWITCH (ID 15590)

Use this parameter to select the digital input signal that is the feedback signal from the Flow Switch.

P3.5.1.59 AHF OVER TEMPERATURE (ID 15513)

Use this parameter to set the digital input signal that activates AHF Over Temperature (fault ID 1118).

10.6.4 ANALOGUE INPUTS**P3.5.2.1.1 AI1 SIGNAL SELECTION (ID 377)**

Use this parameter to connect the AI signal to the analogue input of your choice. This parameter is programmable. See *Table 120 Default functions of the programmable digital and analogue inputs*.

P3.5.2.1.2 AI1 SIGNAL FILTER TIME (ID 378)

Use this parameter to filter out disturbances in the analogue input signal. To activate this parameter, enter a value greater than 0.

**NOTE!**

A long filter time makes the regulation response slow.

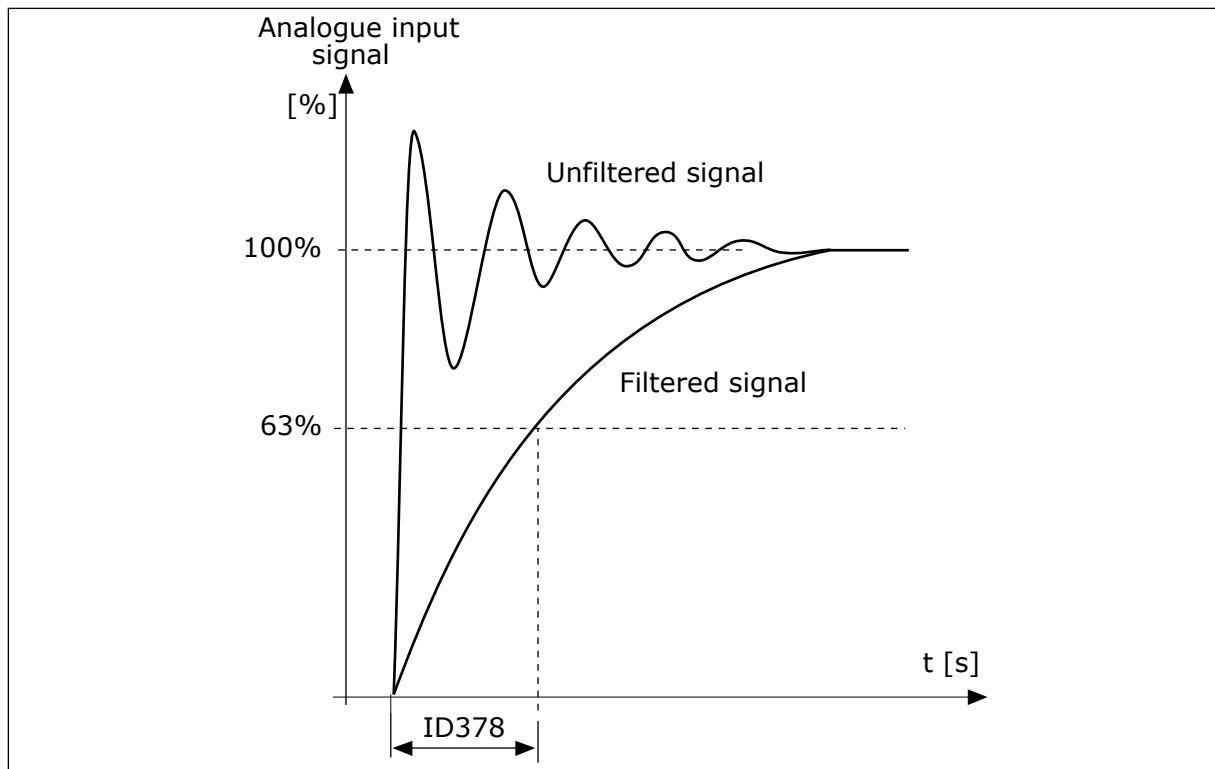

Fig. 57: The AI1 signal filtering

P3.5.2.1.3 AI1 SIGNAL RANGE (ID 379)

Use this parameter to change the range of the analogue signal. The value of this parameter is bypassed if the custom scaling parameters are used.

Use the dip switches on the control board to set the type of the analogue input signal (current or voltage). For more information, see the Installation manual.

It is also possible to use the analogue input signal as frequency reference. The selection of the value 0 or 1 change the scaling of the analogue input signal.

Selection number	Selection name	Description
0	0...10V / 0...20mA	The range of the analogue input signal is 0...10V or 0...20mA (the dip switch settings on the control board tell which one). The input signal is 0...100%.

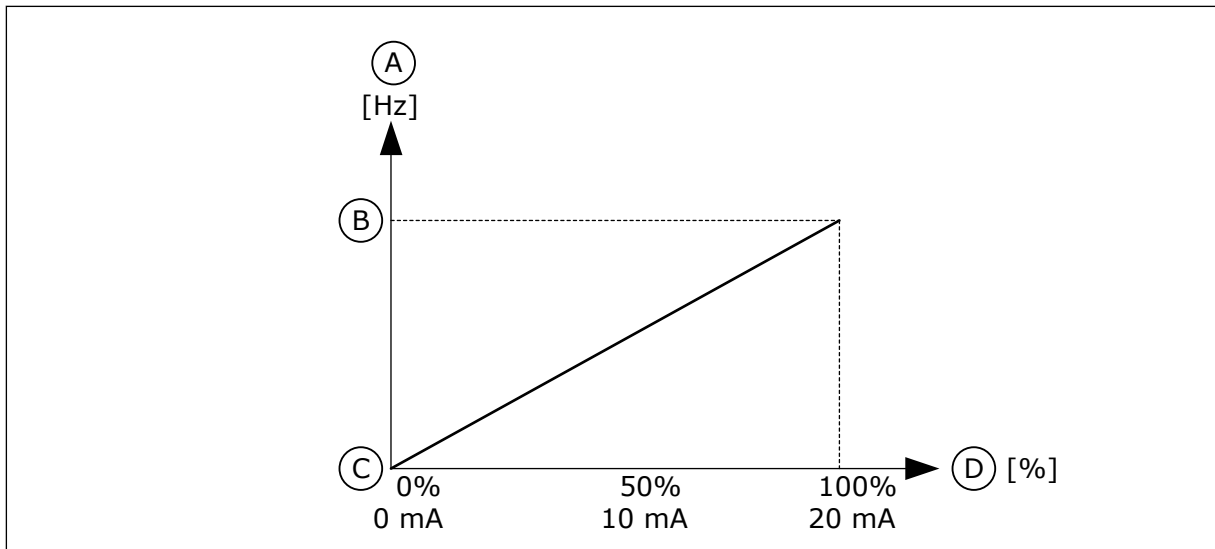

Fig. 58: The analogue input signal range, selection 0

- A. Frequency reference
- B. Max freq reference
- C. Min freq reference
- D. Analogue input signal

Selection number	Selection name	Description
1	2...10V / 4...20mA	The range of the analogue input signal is 2...10V or 4...20mA (the dip switch settings on the control board tell which one). The input signal is 20...100%.

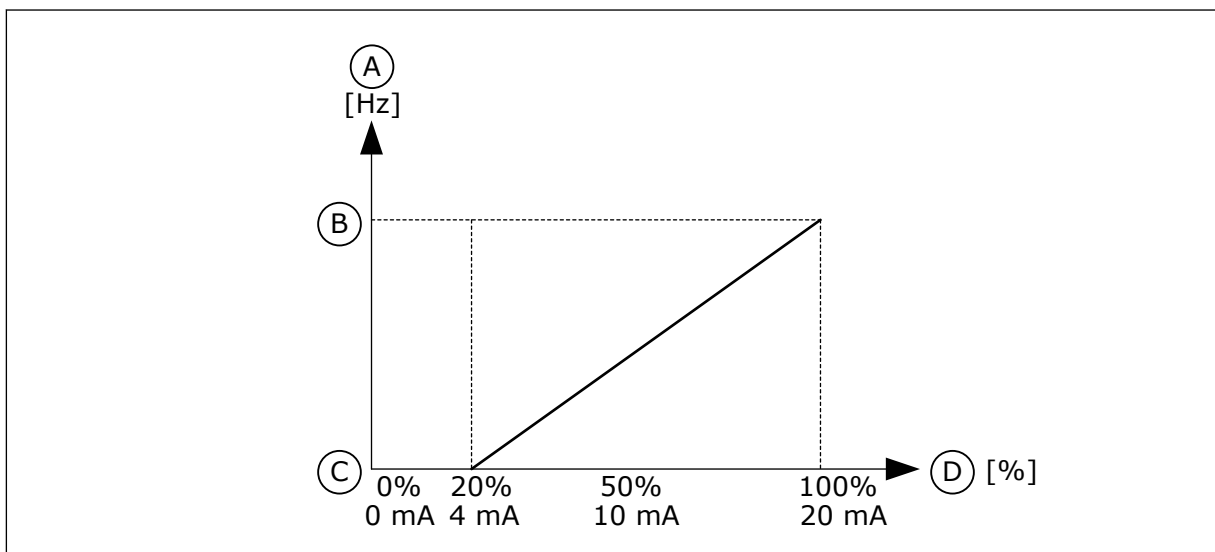

Fig. 59: The analogue input signal range, selection 1

- A. Frequency reference
- B. Max freq reference
- C. Min freq reference
- D. Analogue input signal

P3.5.2.1.4 AI1 CUSTOM. MIN (ID 380)

Use this parameter to adjust the range of the analogue input signal between -160% and 160%.

P3.5.2.1.5 AI1 CUSTOM. MAX (ID 381)

Use this parameter to adjust the range of the analogue input signal between -160% and 160%.

For example, you can use the analogue input signal as frequency reference, and set the parameters P3.5.2.1.4 and P3.5.2.1.5 between 40 and 80%. In these conditions, the frequency reference changes between the Minimum frequency reference and the Maximum frequency reference, and the analogue input signal changes between 8 and 16 mA.

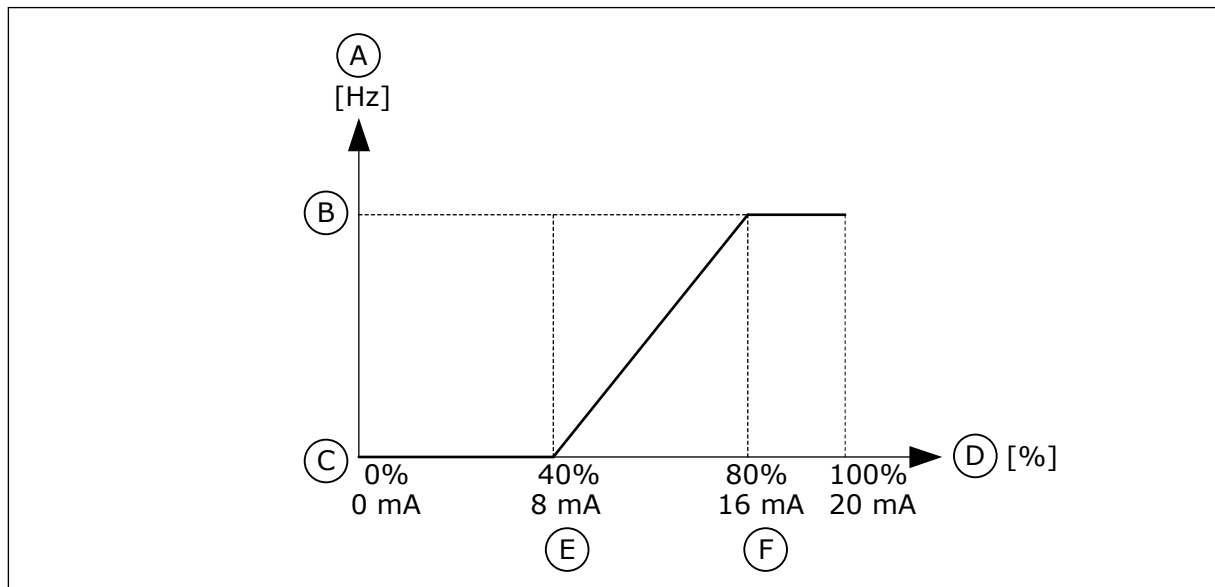

Fig. 60: AI1 signal custom. min/max

- A. Frequency reference
- B. Max freq reference
- C. Min freq reference
- D. Analogue input signal
- E. AI custom min
- F. AI custom max

P3.5.2.1.6 AI1 SIGNAL INVERSION (ID 387)

Use this parameter to invert the analogue input signal. When the analogue input signal is inverted, the curve of the signal becomes the opposite.

It is possible to use the analogue input signal as frequency reference. The selection of the value 0 or 1 change scaling of the analogue input signal.

Selection number	Selection name	Description
0	Normal	No inversion. The value 0% of the analogue input signal agrees to the Minimum Frequency Reference. The value 100% of the the analogue input signal agrees to the Maximum Frequency Reference.

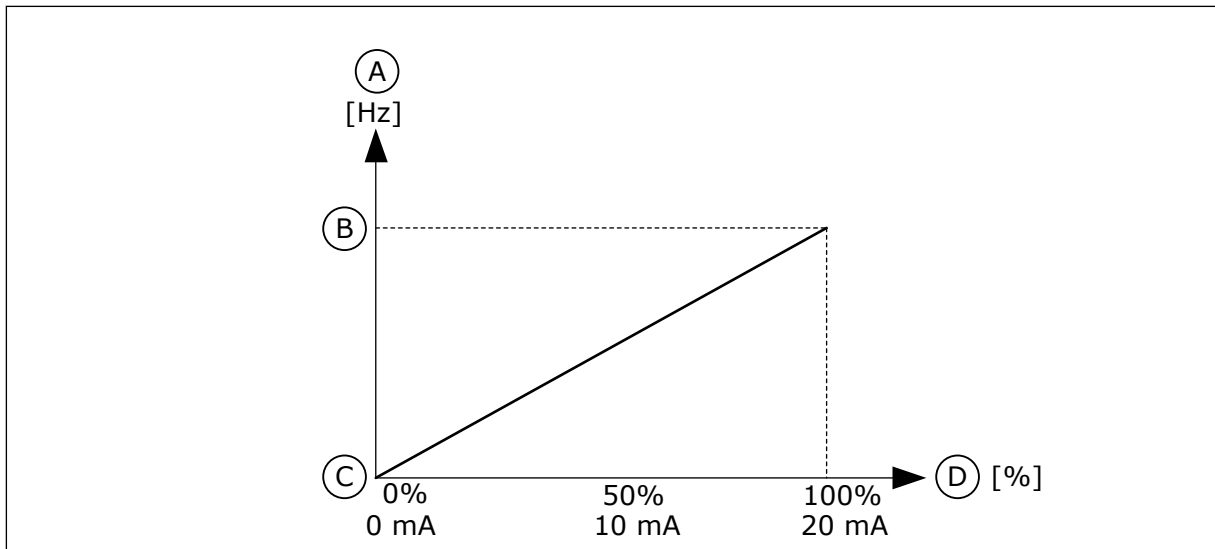

Fig. 61: AI1 signal inversion, selection 0

- A. Frequency reference
- B. Max freq reference
- C. Min freq reference
- D. Analogue input signal

Selection number	Selection name	Description
1	Inverted	Signal inversion. The value 0% of the analogue input signal agrees to the Maximum Frequency Reference. The value 100% of the analogue input signal agrees to the Minimum Frequency Reference.

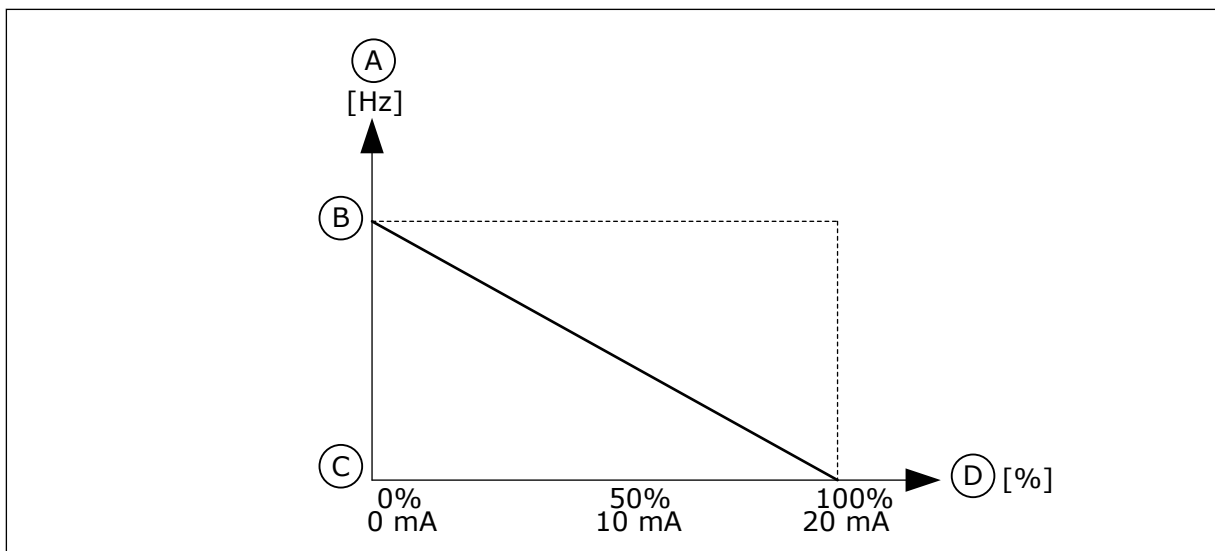

Fig. 62: AI1 signal inversion, selection 1

- A. Frequency reference
- B. Max freq reference
- C. Min freq reference
- D. Analogue input signal

10.6.5 DIGITAL OUTPUTS

P3.5.3.2.1 R01 FUNCTION (ID 11001)

Use this parameter to select a function or a signal that is connected to the relay output.

Table 121: The output signals through R01

Selection number	Selection name	Description
0	Not used	The output is not used.
1	Ready	The AC drive is ready to operate.
2	Run	The AC drive operates (the motor runs).
3	General fault	A fault trip occurred.
4	General fault inverted	A fault trip did not occur.
5	General alarm	An alarm occurred.
6	Reversed	The reverse command is given.
7	At speed	The output frequency becomes the same as the set frequency reference.
8	Thermistor fault	A thermistor fault occurred.
9	Motor regulator activated	One of the limit regulators (for example current limit or torque limit) is activated.
10	Start signal active	The start command of the drive is active.
11	Keypad control active	The selection is keypad control (the active control place is keypad).
12	I/O control B active	The selection is I/O control place B (the active control place is I/O B).
13	Limit supervision 1	The limit supervision becomes active, if the signal value goes below or above the set supervision limit (P3.8.3 or P3.8.7).
14	Limit supervision 2	
15	Fire mode active	The Fire mode function is active.
16	Flushing active	The Flushing function is active.
17	Preset Frequency active	The selection of preset frequency was made with digital input signals.
18	Quick Stop active	The Quick stop function is activated.
19	PID in Sleep mode	The PID controller is in the sleep mode.
20	PID Soft Fill activated	The Soft fill function of the PID controller is activated.
21	PID feedback supervision	The feedback value of the PID controller is not in the supervision limits.
22	ExtPID feedback supervision	The feedback value of the external PID controller is not in the supervision limits.

Table 121: The output signals through R01

Selection number	Selection name	Description
23	Input pressure alarm	The input pressure of the pump is below the value that was set with parameter P3.13.9.7.
24	Frost protection alarm	The measured temperature of the pump is below the level that was set with parameter P3.13.10.5.
25	Time channel 1	The status of Time channel 1.
26	Time channel 2	The status of Time channel 2.
27	Time channel 3	The status of Time channel 3.
28	Fieldbus Control Word bit 13	The digital (relay) output control from the Fieldbus control word bit 13.
29	Fieldbus Control Word bit 14	The digital (relay) output control from the Fieldbus control word bit 14.
30	Fieldbus Control Word bit 15	The digital (relay) output control from the Fieldbus control word bit 15.
31	Fieldbus Process Data In1 bit 0	The digital (relay) output control from the Fieldbus process data In1, bit 0.
32	Fieldbus Process Data In1 bit 1	The digital (relay) output control from the Fieldbus process data In1, bit 1.
33	Fieldbus Process Data In1 bit 2	The digital (relay) output control from the Fieldbus process data In1, bit 2.
34	Maintenance counter 1 alarm	The maintenance counter goes to the alarm limit that is set with parameter P3.16.2.
35	Maintenance counter 1 fault	The maintenance counter goes to the alarm limit that is set with parameter P3.16.3.
36	Block Out.1	The output of the programmable Block 1. See parameter menu M3.19 Block Programming.
37	Block Out.2	The output of the programmable Block 2. See parameter menu M3.19 Block Programming.
38	Block Out.3	The output of the programmable Block 3. See parameter menu M3.19 Block Programming.
39	Block Out.4	The output of the programmable Block 4. See parameter menu M3.19 Block Programming.
40	Block Out.5	The output of the programmable Block 5. See parameter menu M3.19 Block Programming.
41	Block Out.6	The output of the programmable Block 6. See parameter menu M3.19 Block Programming.

Table 121: The output signals through R01

Selection number	Selection name	Description
42	Block Out.7	The output of the programmable Block 7. See parameter menu M3.19 Block Programming.
43	Block Out.8	The output of the programmable Block 8. See parameter menu M3.19 Block Programming.
44	Block Out.9	The output of the programmable Block 9. See parameter menu M3.19 Block Programming.
45	Block Out.10	The output of the programmable Block 10. See parameter menu M3.19 Block Programming.
46	Jockey pump control	The control signal for the external jockey pump.
47	Priming pump control	The control signal for the external priming pump.
48	Auto-cleaning active	The Pump auto-cleaning function is activated.
49	Multi-pump K1 control	The contactor control for the Multi-pump function.
50	Multi-pump K2 control	The contactor control for the Multi-pump function.
51	Multi-pump K3 control	The contactor control for the Multi-pump function.
52	Multi-pump K4 control	The contactor control for the Multi-pump function.
53	Multi-pump K5 control	The contactor control for the Multi-pump function.
54	Multi-pump K6 control	The contactor control for the Multi-pump function.
55	Multi-pump K7 control	The contactor control for the Multi-pump function.
56	Multi-pump K8 control	The contactor control for the Multi-pump function.
69	Selected parameter set	Shows the active parameter set: OPEN = Parameter set 1 active CLOSED = Parameter set 2 active
72	AHF Capacitor Disconnection	
73	AHF Capacitor Disconnection Inverted	
74	Run indication	

P3.5.3.2.2 R01 ON DELAY (ID 11002)

Use this parameter to set the ON delay for the relay output.

P3.5.3.2.3 R01 OFF DELAY (ID 11003)

Use this parameter to set the OFF delay for the relay output.

10.6.6 ANALOGUE OUTPUTS***P3.5.4.1.1 A01 FUNCTION (ID 10050)***

Use this parameter to select a function or a signal that is connected to the analogue output. The contents of the analogue output signal 1 are specified in this parameter. The scaling of the analogue output signal depends on the signal.

Selection number	Selection name	Description
0	Test 0% (Not used)	The analogue output is set to 0% or 20% so that it agrees with parameter P3.5.4.1.3.
1	TEST 100%	The analogue output is set to 100% of the signal (10V / 20mA).
2	Output frequency	The actual output frequency from 0 to Maximum frequency reference.
3	Frequency reference	The actual frequency reference from 0 to Maximum frequency reference.
4	Motor speed	The actual motor speed from 0 to Motor nominal speed.
5	Output current	The output current of the drive from 0 to Motor nominal current.
6	Motor torque	The actual motor torque from 0 to motor nominal torque (100%).
7	Motor power	The actual motor power from 0 to Motor nominal power (100%).
8	Motor voltage	The actual motor voltage from 0 to Motor nominal voltage.
9	DC-link voltage	The actual DC-link voltage 0...1000V.
10	PID Setpoint	The actual setpoint value of the PID Controller (0...100%).
11	PID Feedback	The actual feedback value of the PID Controller (0...100%).
12	PID output	The output of the PID controller (0...100%).
13	ExtPID output	The External PID controller output (0...100%).
14	Fieldbus Process Data In 1	Fieldbus Process Data In 1: 0...10000 (this agrees with 0...100.00%).
15	Fieldbus Process Data In 2	Fieldbus Process Data In 2: 0...10000 (this agrees with 0...100.00%).
16	Fieldbus Process Data In 3	Fieldbus Process Data In 3: 0...10000 (this agrees with 0...100.00%).
17	Fieldbus Process Data In 4	Fieldbus Process Data In 4: 0...10000 (this agrees with 0...100.00%).
18	Fieldbus Process Data In 5	Fieldbus Process Data In 5: 0...10000 (this agrees with 0...100.00%).
19	Fieldbus Process Data In 6	Fieldbus Process Data In 6: 0...10000 (this agrees with 0...100.00%).
20	Fieldbus Process Data In 7	Fieldbus Process Data In 7: 0...10000 (this agrees with 0...100.00%).

Selection number	Selection name	Description
21	Fieldbus Process Data In 8	Fieldbus Process Data In 8: 0...10000 (this agrees with 0...100.00%).
22	Block Out.1	The output of the programmable Block 1: 0...10000 (this agrees with 0...100.00%). See parameter menu M3.19 Drive customizer.
23	Block Out.2	The output of the programmable Block 2: 0...10000 (this agrees with 0...100.00%). See parameter menu M3.19 Drive customizer.
24	Block Out.3	The output of the programmable Block 3: 0...10000 (this agrees with 0...100.00%). See parameter menu M3.19 Drive customizer.
25	Block Out.4	The output of the programmable Block 4: 0...10000 (this agrees with 0...100.00%). See parameter menu M3.19 Drive customizer.
26	Block Out.5	The output of the programmable Block 5: 0...10000 (this agrees with 0...100.00%). See parameter menu M3.19 Drive customizer.
27	Block Out.6	The output of the programmable Block 6: 0...10000 (this agrees with 0...100.00%). See parameter menu M3.19 Drive customizer.
28	Block Out.7	The output of the programmable Block 7: 0...10000 (this agrees with 0...100.00%). See parameter menu M3.19 Drive customizer.
29	Block Out.8	The output of the programmable Block 8: 0...10000 (this agrees with 0...100.00%). See parameter menu M3.19 Drive customizer.
30	Block Out.9	The output of the programmable Block 9: 0...10000 (this agrees with 0...100.00%). See parameter menu M3.19 Drive customizer.
31	Block Out.10	The output of the programmable Block 10: 0...10000 (this agrees with 0...100.00%). See parameter menu M3.19 Drive customizer.

P3.5.4.1.2 A01 FILTER TIME (ID 10051)

Use this parameter to set the filtering time for the analog signal.
The filtering function is disabled when the filtering time is 0. See P3.5.2.1.2.

P3.5.4.1.3 A01 MINIMUM (ID 10052)

Use this parameter to change the range of the analogue output signal.
For example, if '4mA' is selected, the range of analogue output signal is 4..20mA.
Select the signal type (current/voltage) with the dip switches. The analogue output scaling is different in P3.5.4.1.4. See also P3.5.2.1.3.

P3.5.4.1.4 A01 MINIMUM SCALE (ID 10053)

Use this parameter to scale the analogue output signal.
The scaling values (min and max) are given in the process unit that is specified by the selection of the AO function.

P3.5.4.1.5 A01 MAXIMUM SCALE (ID 10054)

Use this parameter to scale the analogue output signal.
The scaling values (min and max) are given in the process unit that is specified by the selection of the AO function.

For example, you can make a selection of the output frequency of the drive for the contents of the analogue output signal, and set parameters P3.5.4.1.4 and P3.5.4.1.5 between 10 and 40 Hz. Then the output frequency of the drive changes between 10 and 40 Hz, and the analogue output signal changes between 0 and 20 mA.

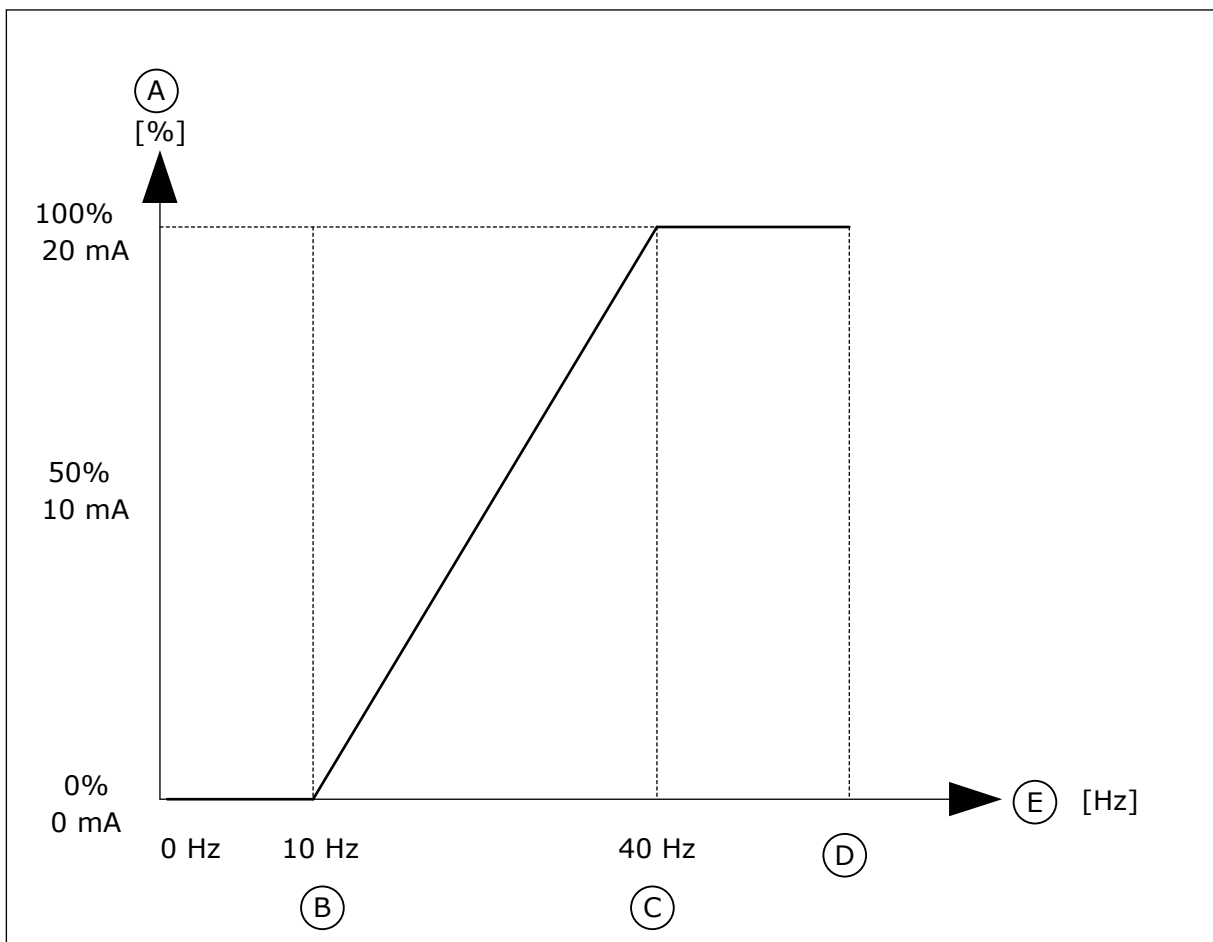

Fig. 63: The scaling of the A01 signal

- | | |
|---------------------------|-----------------------|
| A. Analogue output signal | D. Max freq reference |
| B. AO min scale | E. Output frequency |
| C. AO max scale | |

10.7 FIELD BUS DATA MAP

P3.6.1 FB DATAOUT 1 SELECTION (ID 852)

Use this parameter to select the data that is sent to the fieldbus with the ID number of the parameter or monitor value.

The data is scaled to an unsigned 16-bit format according to the format on the control panel. For example, value 25.5 on the display equals 255.

P3.6.2 FB DATAOUT 2 SELECTION (ID 853)

Use this parameter to select the data that is sent to the fieldbus with the ID number of the parameter or monitor value.

The data is scaled to an unsigned 16-bit format according to the format on the control panel. For example, value 25.5 on the display equals 255.

P3.6.3 FB DATAOUT 3 SELECTION (ID 854)

Use this parameter to select the data that is sent to the fieldbus with the ID number of the parameter or monitor value.

The data is scaled to an unsigned 16-bit format according to the format on the control panel. For example, value 25.5 on the display equals 255.

P3.6.4 FB DATAOUT 4 SELECTION (ID 855)

Use this parameter to select the data that is sent to the fieldbus with the ID number of the parameter or monitor value.

The data is scaled to an unsigned 16-bit format according to the format on the control panel. For example, value 25.5 on the display equals 255.

P3.6.5 FB DATAOUT 5 SELECTION (ID 856)

Use this parameter to select the data that is sent to the fieldbus with the ID number of the parameter or monitor value.

The data is scaled to an unsigned 16-bit format according to the format on the control panel. For example, value 25.5 on the display equals 255.

P3.6.6 FB DATAOUT 6 SELECTION (ID 857)

Use this parameter to select the data that is sent to the fieldbus with the ID number of the parameter or monitor value.

The data is scaled to an unsigned 16-bit format according to the format on the control panel. For example, value 25.5 on the display equals 255.

P3.6.7 FB DATAOUT 7 SELECTION (ID 858)

Use this parameter to select the data that is sent to the fieldbus with the ID number of the parameter or monitor value.

The data is scaled to an unsigned 16-bit format according to the format on the control panel. For example, value 25.5 on the display equals 255.

P3.6.8 FB DATAOUT 8 SELECTION (ID 859)

Use this parameter to select the data that is sent to the fieldbus with the ID number of the parameter or monitor value.

The data is scaled to an unsigned 16-bit format according to the format on the control panel. For example, value 25.5 on the display equals 255.

10.8 PROHIBIT FREQUENCIES

In some processes it can be necessary to avoid some frequencies because they make problems of mechanical resonance. With the Prohibit frequencies function, it is possible to prevent the usage of these frequencies. When the input frequency reference increases, the internal frequency reference stays at the low limit, until the input frequency reference is above the high limit.

P3.7.1 PROHIBIT FREQUENCY RANGE 1 LOW LIMIT (ID 509)

Use this parameter to prevent the drive operating on the prohibited frequencies. In some processes it can be necessary to avoid some frequencies because they cause mechanical resonance.

P3.7.2 PROHIBIT FREQUENCY RANGE 1 HIGH LIMIT (ID 510)

Use this parameter to prevent the drive operating on the prohibited frequencies. In some processes it can be necessary to avoid some frequencies because they cause mechanical resonance.

P3.7.3 PROHIBIT FREQUENCY RANGE 2 LOW LIMIT (ID 511)

Use this parameter to prevent the drive operating on the prohibited frequencies. In some processes it can be necessary to avoid some frequencies because they cause mechanical resonance.

P3.7.4 PROHIBIT FREQUENCY RANGE 2 HIGH LIMIT (ID 512)

Use this parameter to prevent the drive operating on the prohibited frequencies. In some processes it can be necessary to avoid some frequencies because they cause mechanical resonance.

P3.7.5 PROHIBIT FREQUENCY RANGE 3 LOW LIMIT (ID 513)

Use this parameter to prevent the drive operating on the prohibited frequencies. In some processes it can be necessary to avoid some frequencies because they cause mechanical resonance.

P3.7.6 PROHIBIT FREQUENCY RANGE 3 HIGH LIMIT (ID 514)

Use this parameter to prevent the drive operating on the prohibited frequencies. In some processes it can be necessary to avoid some frequencies because they cause mechanical resonance.

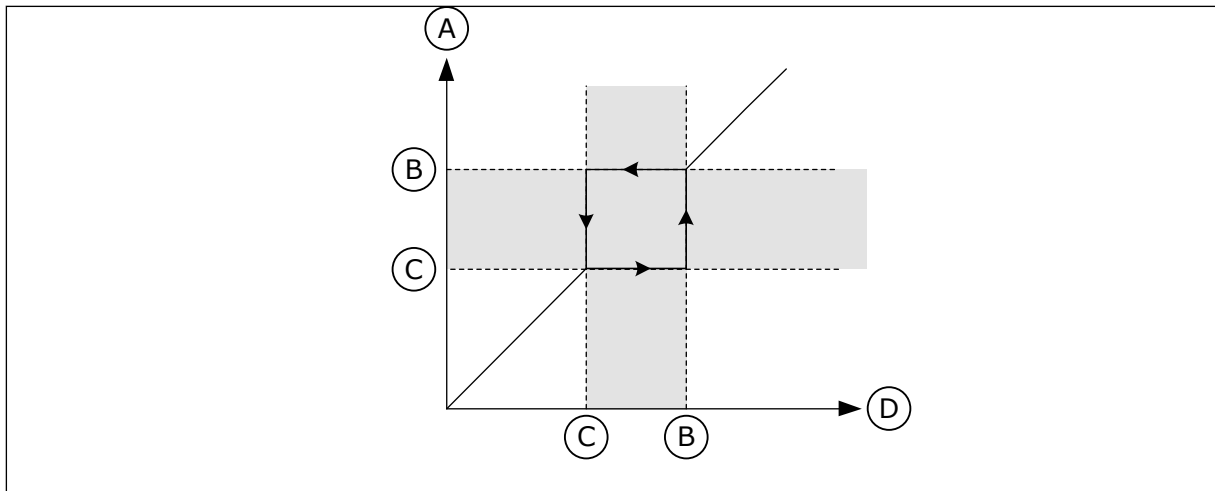

Fig. 64: The prohibited frequencies

- A. Actual Reference
- B. High Lim
- C. Low lim
- D. Requested Reference

P3.7.7 RAMP TIME FACTOR (ID 518)

Use this parameter to set the multiplier of the selected ramp times when the output frequency of the drive is between the prohibited frequency limits. The Ramp Time Factor sets the acceleration and the deceleration time when the output frequency is in a prohibited frequency range. The value of the Ramp Time Factor is multiplied with the value of P3.4.1.2 (Acceleration Time 1) or P3.4.1.3 (Deceleration Time 1). For example, the value 0.1 makes the acceleration/deceleration time ten times shorter.

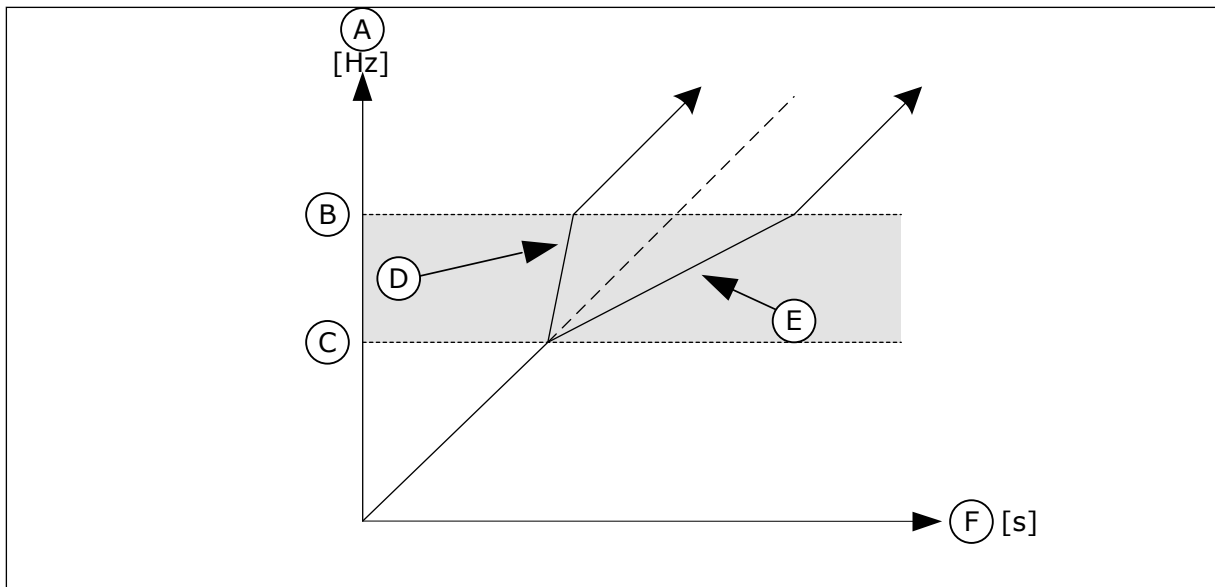

Fig. 65: The parameter Ramp Time Factor

- A. Output Frequency
- B. High Lim
- C. Low Lim
- D. Ramp Time Factor = 0.3
- E. Ramp Time Factor = 2.5
- F. Time

10.9 SUPERVISIONS

P3.8.1 SUPERVISION #1 ITEM SELECTION (ID 1431)

Use this parameter to select the supervision item.
The output of the supervision function can be selected to the relay output.

P3.8.2 SUPERVISION #1 MODE (ID 1432)

Use this parameter to set the supervision mode.
When the 'Low limit' mode is selected, the output of the supervision function is active when the signal is below the supervision limit.
When the 'High limit' mode is selected, the output of the supervision function is active when the signal is above the supervision limit.

P3.8.3 SUPERVISION #1 LIMIT (ID 1433)

Use this parameter to set the supervision limit for the selected item.
The unit shows automatically.

P3.8.4 SUPERVISION #1 LIMIT HYSTERESIS (ID 1434)

Use this parameter to set the supervision limit hysteresis for the selected item.
The unit shows automatically.

P3.8.5 SUPERVISION #2 ITEM SELECTION (ID 1435)

Use this parameter to select the supervision item.
The output of the supervision function can be selected to the relay output.

P3.8.6 SUPERVISION #2 MODE (ID 1436)

Use this parameter to set the supervision mode.

P3.8.7 SUPERVISION #2 LIMIT (ID 1437)

Use this parameter to set the supervision limit for the selected item.
The unit shows automatically.

P3.8.8 SUPERVISION #2 LIMIT HYSTERESIS (ID 1438)

Use this parameter to set the supervision limit hysteresis for the selected item.
The unit shows automatically.

10.10 PROTECTIONS

10.10.1 GENERAL

P3.9.1.2 RESPONSE TO EXTERNAL FAULT (ID 701)

Use this parameter to select the response of the drive to an 'External Fault'.

If a fault occurs, the drive can show a notification of it on the display of the drive. An external fault is activated with a digital input signal. The default digital input is DI3. You can also program the response data into a relay output.

P3.9.1.3 INPUT PHASE FAULT (ID 730)

Use this parameter to select the supply phase configuration of the drive.



NOTE!

If you use the 1-phase supply, the value of this parameter must be set to '1-phase support'.

P3.9.1.4 UNDERVOLTAGE FAULT (ID 727)

Use this parameter to select if undervoltage faults are saved to the fault history or not.

P3.9.1.5 RESPONSE TO OUTPUT PHASE FAULT (ID 702)

Use this parameter to select the response of the drive to an 'Output Phase' fault. If the measurement of the motor current detects that there is no current in 1 motor phase, an output phase fault occurs.
See P3.9.1.2.

P3.9.1.6 RESPONSE TO FIELD BUS COMMUNICATION FAULT (ID 733)

Use this parameter to select the response of the drive to a 'Fieldbus Timeout' fault. If the data connection between the master and the fieldbus board is defective, a fieldbus fault occurs.

P3.9.1.7 SLOT COMMUNICATION FAULT (ID 734)

Use this parameter to select the response of the drive to a 'Slot Communication' fault. If the drive detects a defective option board, a slot communication fault occurs.
See P3.9.1.2.

P3.9.1.8 THERMISTOR FAULT (ID 732)

Use this parameter to select the response of the drive to a 'Thermistor' fault. If the thermistor detects too high temperature, a thermistor fault occurs.
See P3.9.1.2.

P3.9.1.9 PID SOFT FILL FAULT (ID 748)

Use this parameter to select the response of the drive to a 'PID Soft Fill' fault. If the PIDFeedback value does not reach the set level within the time limit, a soft fill fault occurs.
See P3.9.1.2.

P3.9.1.10 RESPONSE TO PID SUPERVISION FAULT (ID 749)

Use this parameter to select the response of the drive to a 'PID Supervision' fault.

If the PID feedback value is not within the supervision limits for longer than the supervision delay, a PID supervision fault occurs.
See P3.9.1.2.

P3.9.1.11 RESPONSE TO EXTERNAL PID SUPERVISION FAULT (ID 757)

Use this parameter to select the response of the drive to a 'PID Supervision' fault.
If the PID feedback value is not within the supervision limits for longer than the supervision delay, a PID supervision fault occurs.
See P3.9.1.2.

P3.9.1.13 PRESET ALARM FREQUENCY (ID 183)

Use this parameter to set the frequency of the drive when a fault is active and the response to the fault is set to 'Alarm + Preset Frequency'.

P3.9.1.14 RESPONSE TO SAFE TORQUE OFF (STO) FAULT (ID 775)

Use this parameter to select the response of the drive to a 'STO Fault'.

This parameter defines drive operation when Safe Torque Off (STO) function is activated (e.g. emergency stop button has been pressed or some other STO operation has been activated).
See P3.9.1.2.

10.10.2 MOTOR THERMAL PROTECTIONS

The motor thermal protection prevents the motor from becoming too hot.

The AC drive can supply a current that is higher than the nominal current. The high current can be necessary to the load, and it must be used. In these conditions, there is a risk of a thermal overload. Low frequencies have a higher risk. At low frequencies, the cooling effect and the capacity of the motor decrease. If the motor has an external fan, the load reduction at low frequencies is small.

The motor thermal protection is based on calculations. The protection function uses the output current of the drive to know what is the load on the motor. If the control board is not energised, the calculations are reset.

To adjust the thermal protection of the motor, use the parameters from P3.9.2.1 to P3.9.2.5. You can monitor the thermal status of the motor on the display of the control panel. See Chapter 3 *User interfaces*.



NOTE!

If you use long motor cables (max. 100 m) with small drives (≤ 1.5 kW), the motor current that the drive measures can be much higher than the actual motor current. It is because there are capacitive currents in the motor cable.



CAUTION!

Make sure that the airflow to the motor is not blocked. If the airflow is blocked, the function does not protect the motor, and the motor can become too hot. This can cause damage to the motor.

P3.9.2.1 MOTOR THERMAL PROTECTION (ID 704)

Use this parameter to select the response of the drive to a 'Motor Overtemperature' fault. If the motor thermal protection function detects that the temperature of the motor is too high, a motor overtemperature fault occurs.



NOTE!

If you have a motor thermistor, use it to protect the motor. Set the value of this parameter to 0.

P3.9.2.2 AMBIENT TEMPERATURE (ID 705)

Use this parameter to set the ambient temperature where the motor is installed. The temperature value is given in celsius or fahrenheit degrees.

P3.9.2.3 ZERO SPEED COOLING FACTOR (ID 706)

Use this parameter to set the cooling factor at 0 speed in relation to the point where the motor operates at nominal speed without external cooling.

The default value is set for conditions where there is no external fan. If you use an external fan, you can set the value higher than without the fan, for example at 90%.

If you change parameter P3.1.1.4 (Motor Nominal Current), parameter P3.9.2.3 is automatically set to its default value.

Although you change this parameter, it does not have an effect on the maximum output current of the drive. Only parameter P3.1.3.1 Motor Current Limit can change the maximum output current.

The corner frequency for the thermal protection is 70% of the value of the parameter P3.1.1.2 Motor Nominal Frequency.

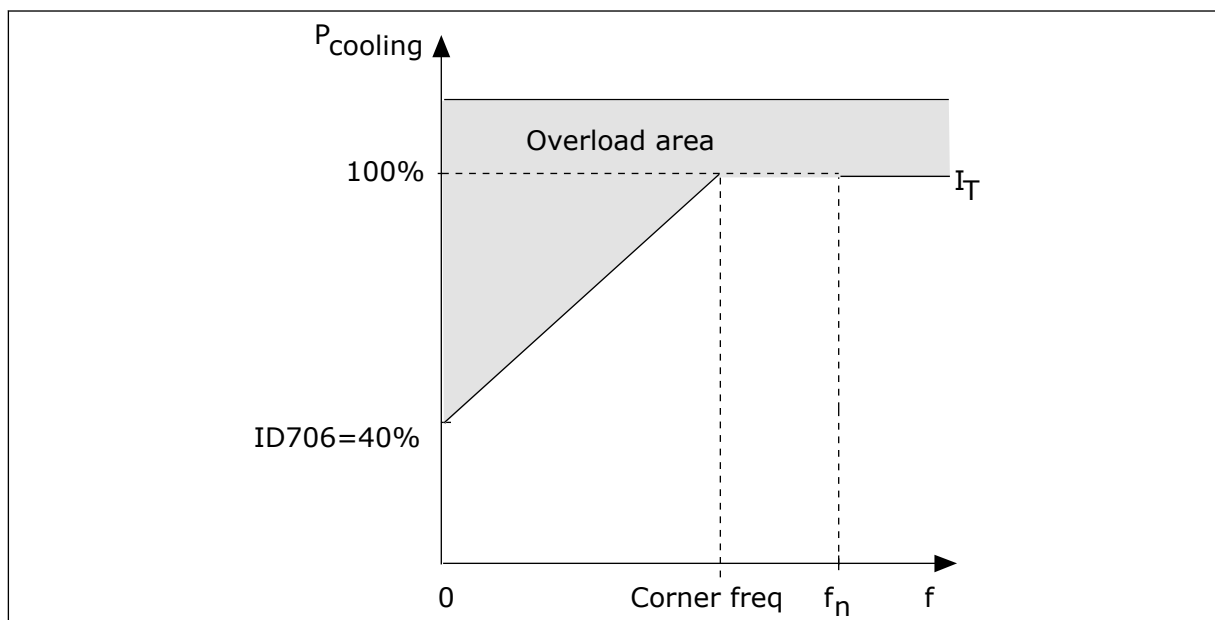

Fig. 66: The motor thermal current I_T curve

P3.9.2.4 MOTOR THERMAL TIME CONSTANT (ID 707)

Use this parameter to set the motor thermal time constant.

The time constant is the time within which the calculated thermal stage has reached 63% of its final value. The final thermal stage equals to running the motor continuously with nominal load at nominal speed. The length of the time constant is in relation with the dimension of the motor. The bigger the motor, the longer the time constant.

In different motors, the motor thermal time constant is different. It also changes between different motor manufacturers. The default value of the parameter changes from dimension to dimension.

The t_6 -time is the time in seconds that the motor can safely operate at 6 times the rated current. It is possible that the motor manufacturer gives the data with the motor. If you know the t_6 of the motor, you can set the time constant parameter with its help. Usually, the motor thermal time constant in minutes is $2 \cdot t_6$. When the drive is in the STOP state, the time constant is internally increased to 3 times the set parameter value, because the cooling operates based on convection.

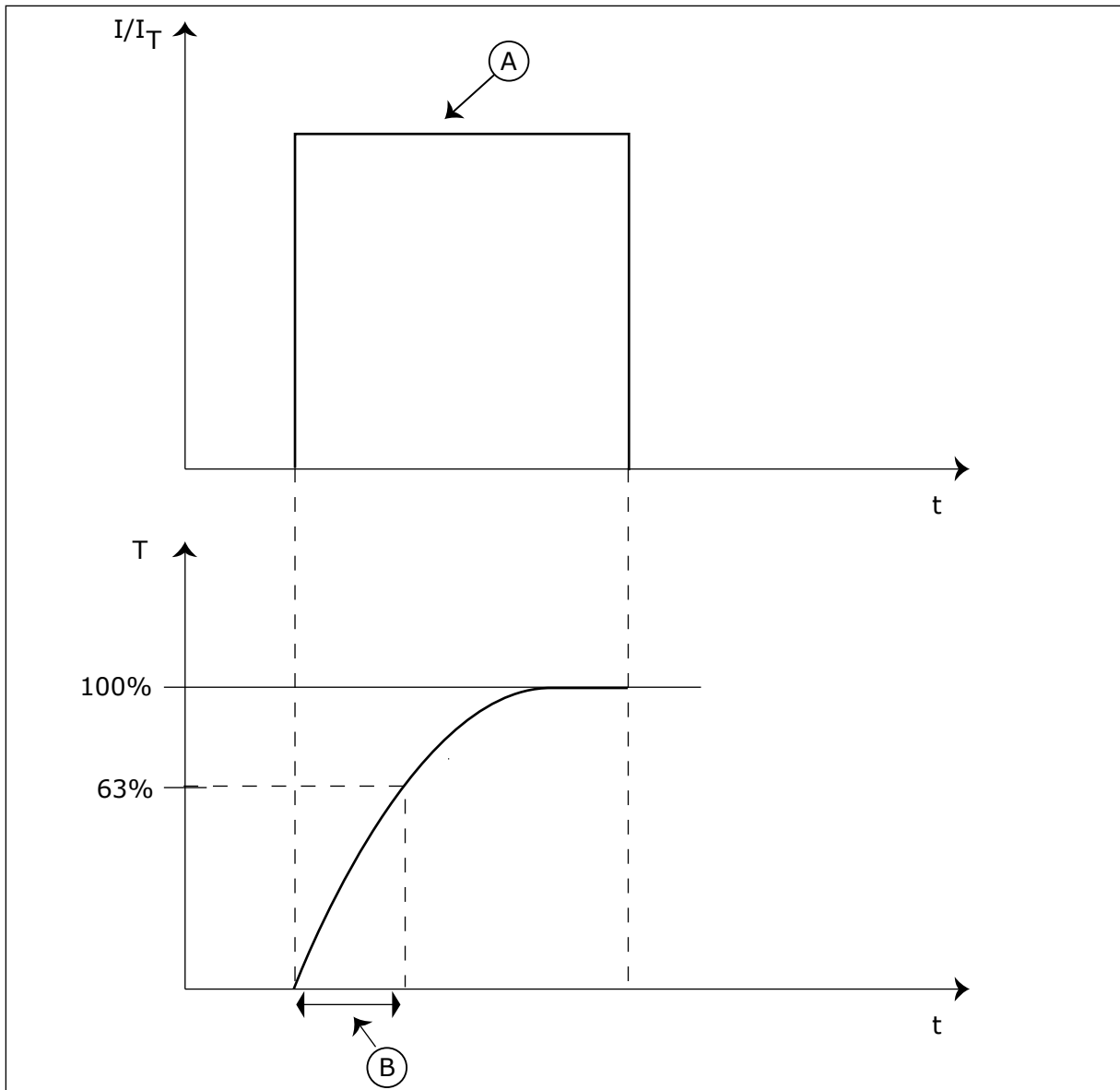

Fig. 67: The motor thermal time constant

A. Current

B. T = Motor thermal time constant

P3.9.2.5 MOTOR THERMAL LOADABILITY (ID 708)

Use this parameter to set the thermal loadability of the motor.
 For example, if you set the value to 130%, the motor goes to the nominal temperature with 130% of the motor nominal current.

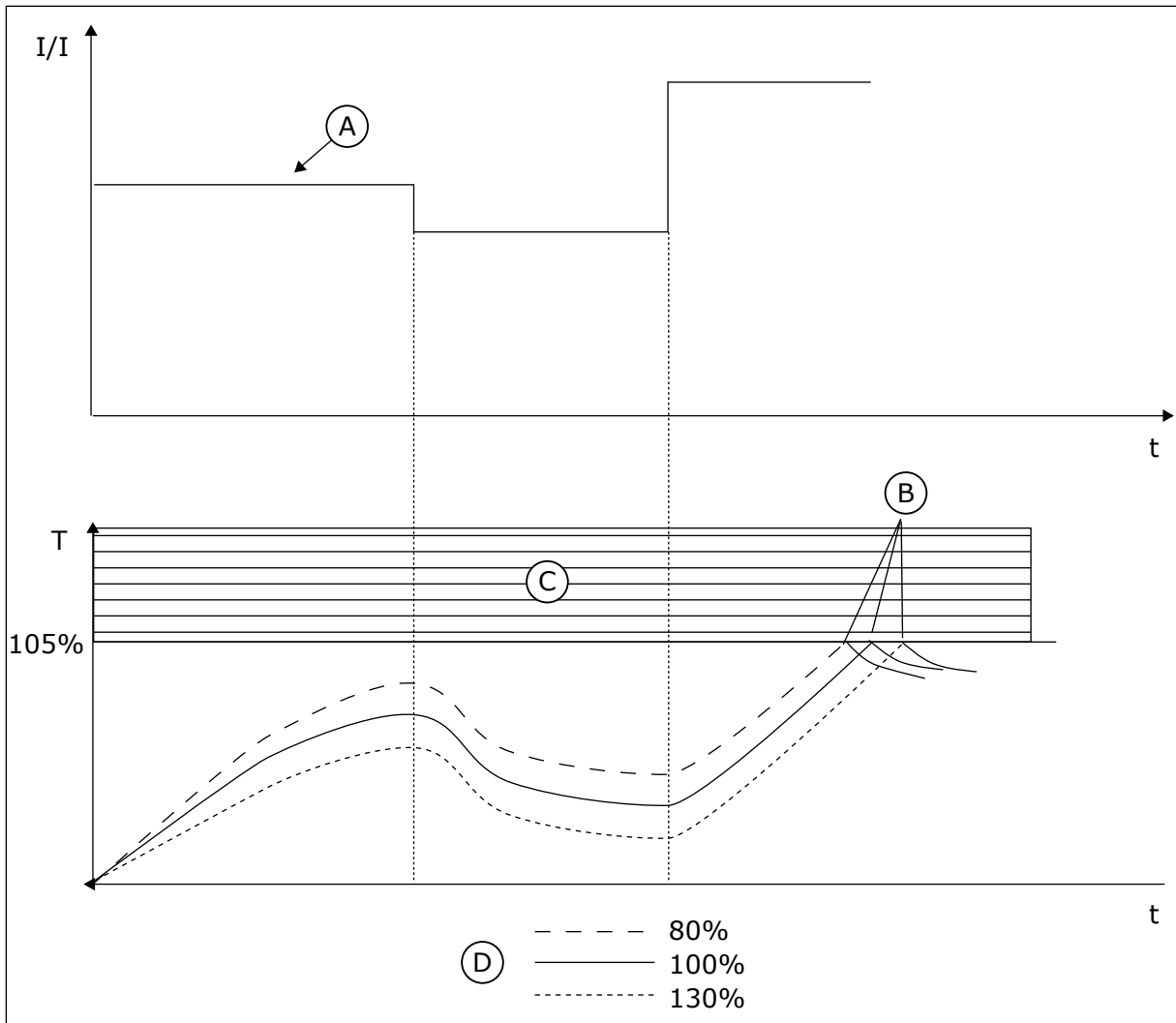

Fig. 68: The calculation of the motor temperature

- A. Current
- B. Fault/Alarm
- C. Trip area
- D. Loadability

10.10.3 MOTOR STALL PROTECTION

The motor stall protection function gives protection to the motor against short overloads. An overload can be caused, for example, by a stalled shaft. It is possible to set the reaction time of the stall protection shorter than that of the motor thermal protection.

The stall status of the motor is specified with parameters P3.9.3.2 Stall Current and P3.9.3.4 Stall Frequency Limit. If the current is higher than the limit, and the output frequency is lower than the limit, the motor is in a stall status.

The stall protection is a type of overcurrent protection.



NOTE!

If you use long motor cables (max. 100 m) with small drives (≤ 1.5 kW), the motor current that the drive measures can be much higher than the actual motor current. It is because there are capacitive currents in the motor cable.

P3.9.3.1 MOTOR STALL FAULT (ID 709)

Use this parameter to select the response of the drive to a 'Motor Stall' fault.
If the stall protection detects that the shaft of the motor is stalled, a motor stall fault occurs.

P3.9.3.2 STALL CURRENT (ID 710)

Use this parameter to set the limit above which the current of the motor must stay for a stall stage to occur.

If the value of the motor current limit parameter changes, this parameter is automatically set to 90 % of the current limit.

You can set the value of this parameter between 0.0 and $2 \cdot I_L$. For a stall status to occur, the current must be higher than this limit. If parameter P3.1.3.1 Motor Current Limit changes, this parameter is automatically calculated to 90% of the current limit.

**NOTE!**

The value of the Stall Current must be below the motor current limit.

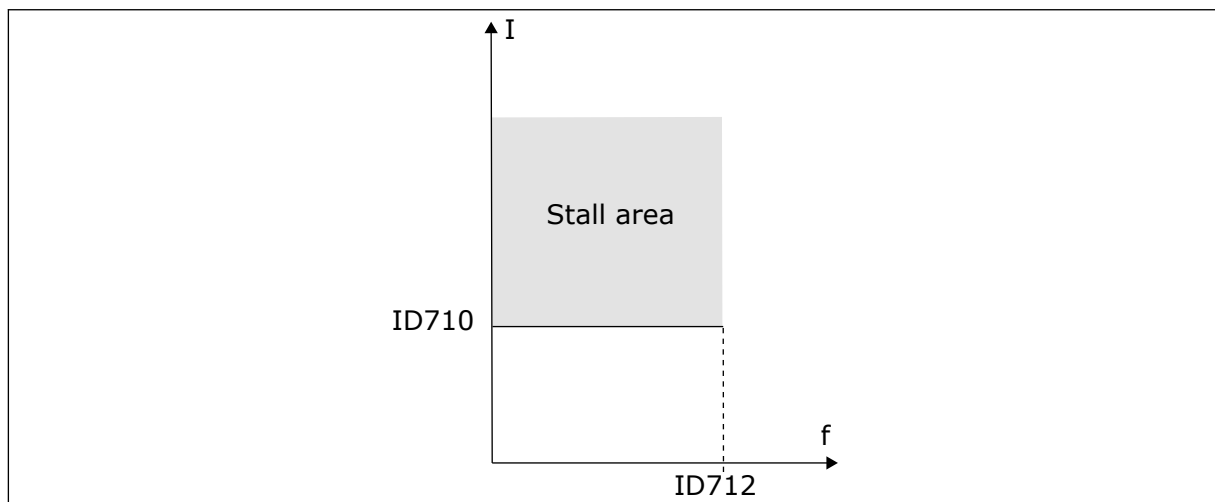

Fig. 69: The stall characteristics settings

P3.9.3.3 STALL TIME LIMIT (ID 711)

Use this parameter to set the maximum time for a stall stage.

This is the maximum time for the stall stage to be active before a motor stall fault occurs.

You can set the value of this parameter between 1.0 and 120.0 s. An internal counter counts the stall time.

If the stall time counter value goes above this limit, the protection causes the drive to trip.

P3.9.3.4 STALL FREQUENCY LIMIT (ID 712)

Use this parameter to set the limit below which the output frequency of the drive must stay for a stall stage to occur.

**NOTE!**

For a stall state to occur, the output frequency must be below this limit for a certain time.

10.10.4 UNDERLOAD (DRY PUMP) PROTECTION

The motor underload protection makes sure that there is a load on the motor when the drive operates. If the motor loses the load, a problem can occur in the process. For example, a belt can break or a pump become dry.

You can adjust the motor underload protection with parameters P3.9.4.2 (Underload Protection: Field Weakening Area Load) and P3.9.4.3 (Underload Protection: Zero Frequency Load). The underload curve is a squared curve between the zero frequency and the field weakening point. The protection is not active below 5 Hz. The underload time counter does not operate below 5 Hz.

The values of the underload protection parameters are set in percentage of the nominal torque of the motor. To find the scaling ratio for the internal torque value, use the data in the name plate data of the motor, the motor nominal current and the nominal current of the drive IH. If you use another current than the nominal motor current, the precision of the calculation decreases.

**NOTE!**

If you use long motor cables (max. 100 m) with small drives (≤ 1.5 kW), the motor current that the drive measures can be much higher than the actual motor current. It is because there are capacitive currents in the motor cable.

P3.9.4.1 UNDERLOAD FAULT (ID 713)

Use this parameter to select the response of the drive to an 'Underload' fault. If the underload protection function detects that there is not a sufficient load on the motor, an underload fault occurs.

P3.9.4.2 UNDERLOAD PROTECTION: FIELD WEAKENING AREA LOAD (ID 714)

Use this parameter to set the minimum torque that the motor needs when the output frequency of the drive is higher than the frequency of the weakening point. You can set the value of this parameter between 10.0 and 150.0% x T_{nMotor}. This value is the limit for the minimum torque when the output frequency is above the field weakening point.

If you change parameter P3.1.1.4 (Motor Nominal Current), this parameter goes automatically back to its default value. See *10.10.4 Underload (Dry pump) protection*.

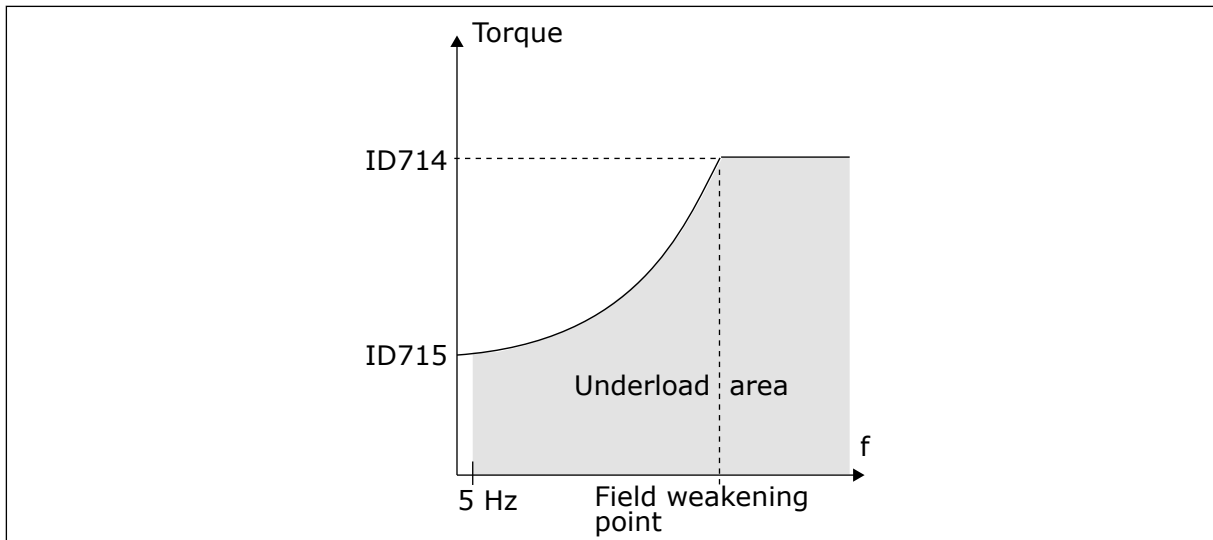

Fig. 70: Setting of the minimum load

P3.9.4.3 UNDERLOAD PROTECTION: ZERO FREQUENCY LOAD (ID 715)

Use this parameter to set the minimum torque that the motor needs when the output frequency of the drive is 0.

If you change the value of parameter P3.1.1.4, this parameter is automatically restored to the default value.

P3.9.4.4 UNDERLOAD PROTECTION: TIME LIMIT (ID 716)

Use this parameter to set the maximum time for an underload state.

This is the maximum time for the underload state to be active before an underload fault occurs.

You can set the time limit between 2.0 and 600.0 s.

An internal counter counts the underload time. If the value of the counter goes above this limit, the protection causes the drive to trip. The drive trips as is set in parameter P3.9.4.1 Underload Fault. If the drive stops, the underload counter goes back to 0.

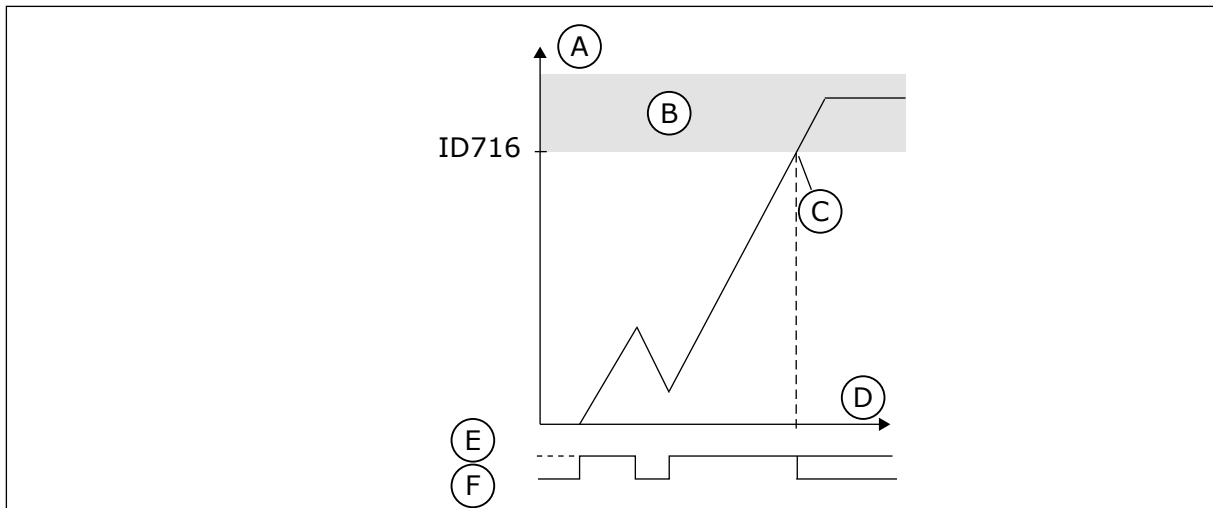

Fig. 71: The Underload time counter function

- | | |
|---------------------------|-----------------|
| A. Underload time counter | D. Time |
| B. Trip area | E. Underload |
| C. Trip/warning ID713 | F. No underload |

10.10.5 QUICK STOP

P3.9.5.1 QUICK STOP MODE (ID 1276)

Use this parameter to select how the drive stops when the quick stop command is given from DI or Fieldbus.

P3.9.5.2 QUICK STOP ACTIVATION (ID 1213)

Use this parameter to select the digital input signal that activates a Quick Stop function. The Quick Stop function stops the drive regardless of the control place or the state of the control signals.

P3.9.5.3 QUICK STOP DECELERATION TIME (ID 1256)

Use this parameter to set the time that is necessary for the output frequency to decrease from maximum frequency to 0 when a quick stop command is given. The value of this parameter is applied only when the quick stop mode parameter is set to 'Quick Stop Deceleration time'.

P3.9.5.4 RESPONSE TO QUICK STOP FAULT (ID 744)

Use this parameter to select the response of the drive to a 'Quick Stop' fault. If the quick stop command is given from DI or Fieldbus, a quick stop fault occurs.

With the quick stop function, you can stop the drive in an unusual procedure from I/O or Fieldbus in unusual conditions. When the quick stop function is active, you can make the drive decelerate and stop. It is possible to program an alarm or fault to put a mark in the fault history that there was a request for a quick stop.



CAUTION!

Do not use the quick stop function as an emergency stop. An emergency stop must stop the power supply to the motor. The quick stop function does not do this.

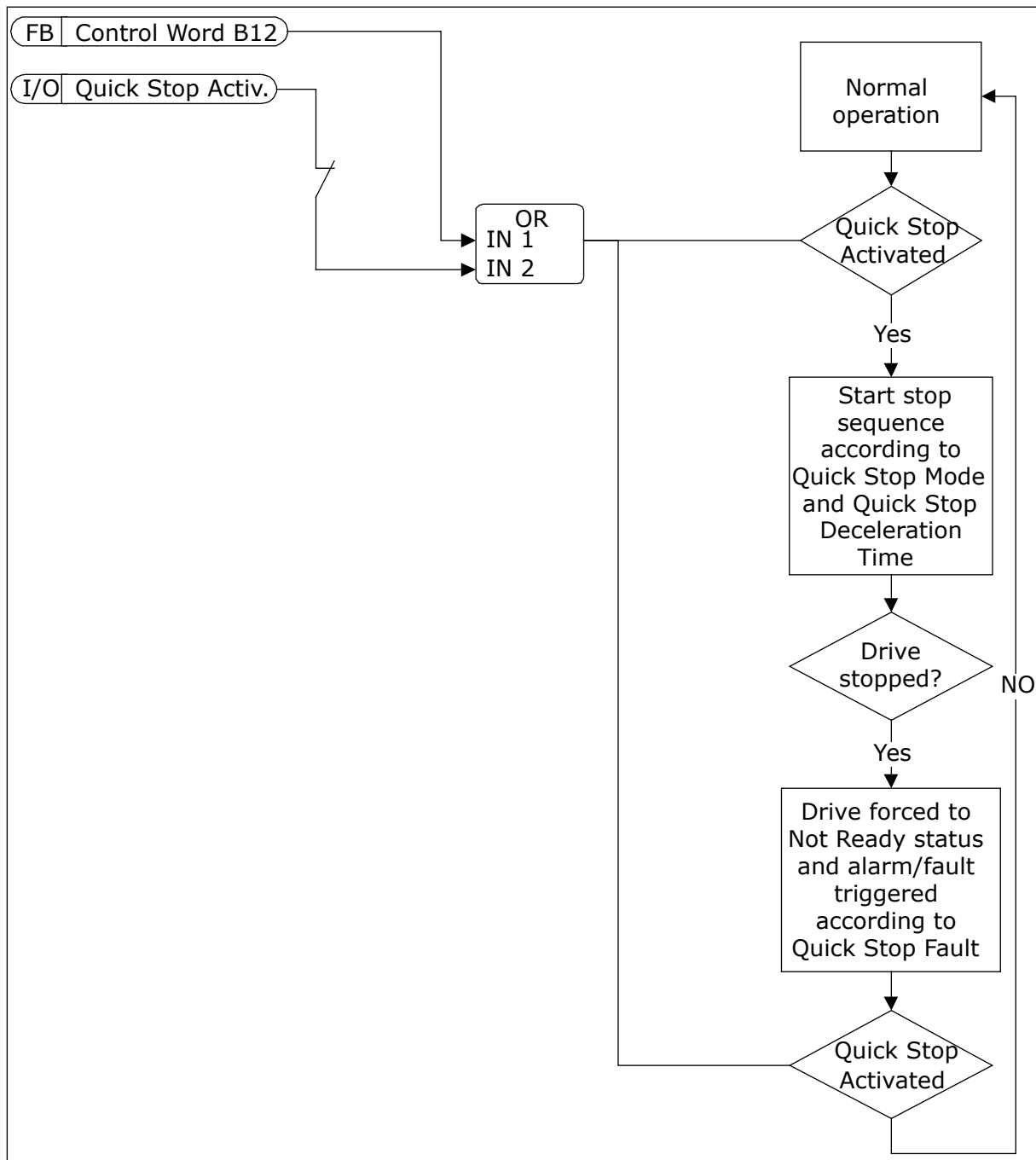

Fig. 72: The quick stop logic

10.10.6 AI LOW PROTECTION

P3.9.8.1 ANALOGUE INPUT LOW PROTECTION (ID 767)

Use this parameter to select when the AI Low supervision is enabled.

Use the AI Low Protection to find failures in the analogue input signals. This function gives protection only to the analogue inputs that are used as frequency reference or in the PID/ExtPID controllers.

You can have the protection on when the drive is in the RUN status, or in the RUN and STOP statuses.

Selection number	Selection name	Description
1	Protection disabled	
2	Protection enabled in RUN status	The protection is enabled only when the drive is in the RUN status.
3	Protection enabled in RUN and STOP status	The protection is enabled in the 2 statuses, RUN and STOP.

P3.9.8.2 ANALOGUE INPUT LOW FAULT (ID 700)

Use this parameter to select the response of the drive to an 'AI Low' fault.

If the analogue input signal becomes less than 50% of the minimum signal for 500ms, an AI Low fault occurs.

If AI Low Protection is enabled with parameter P3.9.8.1, this parameter gives a response for the fault code 50 (Fault ID 1050).

The AI low protection function monitors the signal level of the analogue inputs 1-6. If the analogue input signal becomes less than 50% of the minimum signal for 500 ms, an AI Low fault or alarm shows.



NOTE!

You can use the value *Alarm + Previous Freq* only when you use analogue input 1 or analogue input 2 as frequency reference.

Selection number	Selection name	Description
0	No Action	AI Low Protection is not used.
1	Alarm	
2	Alarm, preset frequency	The frequency reference is set as in P3.9.1.13 Preset Alarm Frequency.
3	Alarm, previous frequency	The last valid frequency is kept as frequency reference.
4	Fault	The drive stops as is set in P3.2.5 Stop Mode.
5	Fault, coasting	The drive stops by coasting.

10.11 AUTOMATIC RESET

P3.10.1 AUTOMATIC RESET (ID 731)

Use this parameter to enable the Automatic reset function.
To select the faults that are reset automatically, enter the value *0* or *1* to parameters from P3.10.6 to P3.10.13.



NOTE!

The automatic reset function is available only for some fault types.

P3.10.2 RESTART FUNCTION (ID 719)

Use this parameter to select the start mode for the Automatic reset function.

P3.10.3 WAIT TIME (ID 717)

Use this parameter to set the wait time before the first reset is done.

P3.10.4 TRIAL TIME (ID 718)

Use this parameter to set the trial time for the automatic reset function.
During the trial time, the automatic reset function tries to reset the faults that occur. The time count starts from the first automatic reset. The next fault starts the trial time count again.

P3.10.5 NUMBER OF TRIALS (ID 759)

Use this parameter to set the total number of autoreset trials.
If the number of trials during the trial time is more than the value of this parameter, a permanent fault shows. If not, the fault goes out of view after the trial time is completed.
The fault type does not have an effect on the maximum number of trials.

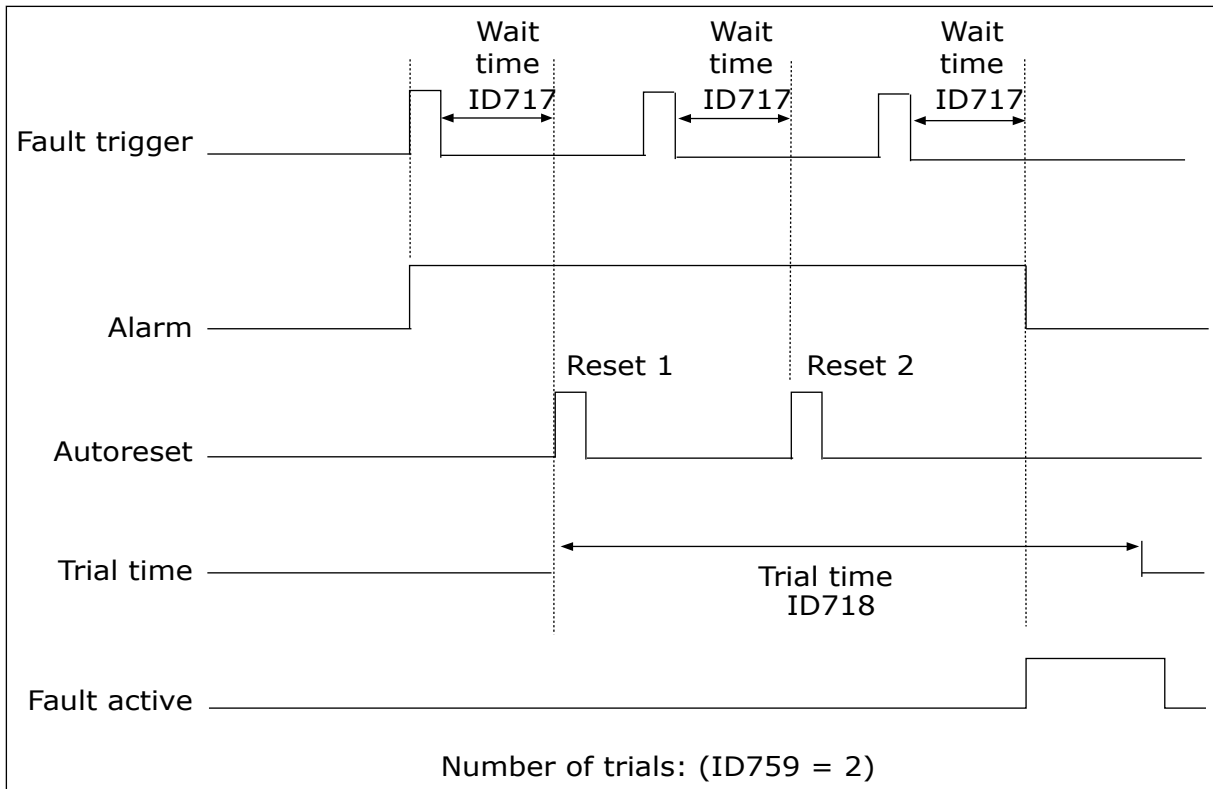

Fig. 73: The Automatic reset function

P3.10.6 AUTORESET: UNDERVOLTAGE (ID 720)

Use this parameter to enable the automatic reset after an undervoltage fault.

P3.10.7 AUTORESET: OVERVOLTAGE (ID 721)

Use this parameter to enable the automatic reset after an overvoltage fault.

P3.10.8 AUTORESET: OVERCURRENT (ID 722)

Use this parameter to enable the automatic reset after an overcurrent fault.

P3.10.9 AUTORESET: AI LOW (ID 723)

Use this parameter to enable the automatic reset after a fault caused by low AI signal.

P3.10.10 AUTORESET: UNIT OVERTEMPERATURE (ID 724)

Use this parameter to enable the automatic reset after a fault caused by unit overtemperature.

P3.10.11 AUTORESET: MOTOR OVERTEMPERATURE (ID 725)

Use this parameter to enable the automatic reset after a fault caused by motor overtemperature.

P3.10.12 AUTORESET: EXTERNAL FAULT (ID 726)

Use this parameter to enable the automatic reset after an external fault.

P3.10.13 AUTORESET: UNDERLOAD FAULT (ID 738)

Use this parameter to enable the automatic reset after an underload fault.

P3.10.14 AUTORESET: PID SUPERVISION FAULT (ID 776)

Use this parameter to enable the automatic reset after a PID supervision fault.

P3.10.15 AUTORESET: EXT PID SUPERVISION FAULT (ID 777)

Use this parameter to enable the automatic reset after an external PID supervision fault.

10.12 APPLICATION SETTINGS**P3.11.1 PASSWORD (ID 1806)**

Use this parameter to set the administrator password.

P3.11.2 C/F SELECTION (ID 1197)

Use this parameter to set the temperature measuring unit. The system shows all the temperature-related parameters and monitoring values in the set unit.

P3.11.3 KW/HP SELECTION (ID 1198)

Use this parameter to set the power measuring unit. The system shows all the power-related parameters and monitoring values in the set unit.

3.11.4 MULTIMONITOR VIEW (ID 1196)

Use this parameter to set the division of the display of the control panel into sections in the multimonitor view.

10.13 TIMER FUNCTIONS

The timer functions make it possible for the internal RTC (Real Time Clock) to control functions. All the functions that can be controlled with a digital input, can also be controlled with the RTC, with time channels 1-3. It is not necessary to have an external PLC to control a digital input. You can program the closed and opened intervals of the input internally.

To get the best results of the timer functions, install a battery, and make the settings of the Real Time Clock carefully in the Start-up wizard. The battery is available as an option.

**NOTE!**

We do not recommend that you use the timer functions without an auxiliary battery. The time and date settings of the drive are reset at each power down, if there is no battery for the RTC.

TIME CHANNELS

You can assign the output of the interval and/or timer functions to time channels 1-3. You can use the time channels to control on/off type functions, for example relay outputs or digital inputs. To configure the on/off logic of the time channels, assign intervals and/or timers to them. A time channel can be controlled by many different intervals or timers.

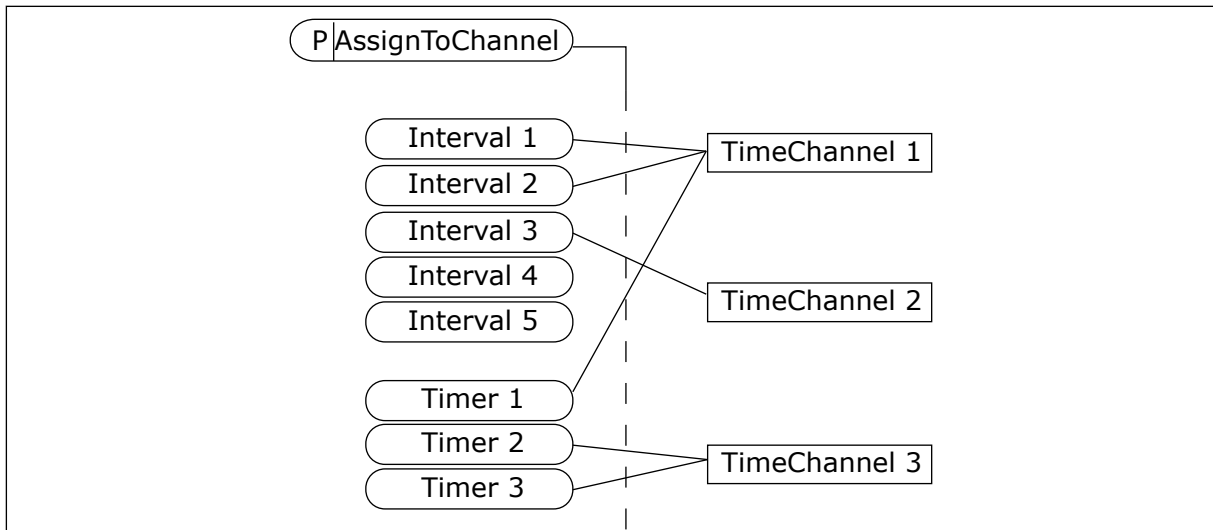

Fig. 74: Assigning intervals and timers to time channels is flexible. Every interval and timer has a parameter with which you can assign them to a time channel.

INTERVALS

Use parameters to give each interval an ON Time and OFF Time. It is the daily active time of the interval during the days set with parameters From Day and To Day. For example, with the parameter settings below, the interval is active from 7 am to 9 am from Monday to Friday. The time channel is like a digital input, but virtual.

ON Time: 07:00:00
 OFF Time: 09:00:00
 From Day: Monday
 To Day: Friday

TIMERS

Use the timers to set a time channel as active for a period with a command from a digital input or a time channel.

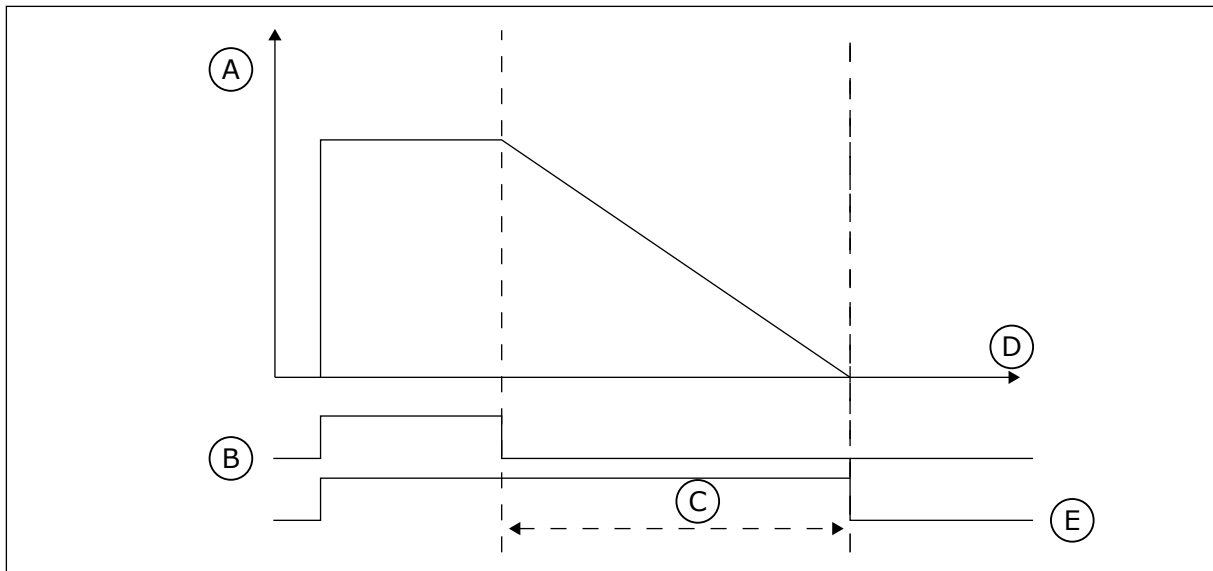

Fig. 75: The activation signal comes from a digital input or a virtual digital input, like a time channel. The timer counts down from the falling edge.

- | | |
|-------------------|---------|
| A. Remaining time | D. Time |
| B. Activation | E. OUT |
| C. Duration | |

The parameters below will set the timer active when the digital input 1 on the slot A is closed. They will also keep the timer active for 30 s after it is opened.

- Duration: 30 s
- Timer: DigIn SlotA.1

You can use a duration of 0 seconds to override a time channel that is activated from a digital input. There is no off delay after the falling edge.

Example:

Problem:

The AC drive is in a warehouse and controls air conditioning. It must operate between 7 am and 5 pm on weekdays and between 9 am and 1 pm on weekends. It is also necessary for the drive to operate outside these hours, if there are personnel in the building. The drive must continue to operate 30 minutes after the personnel has left.

Solution:

Set 2 intervals, 1 for weekdays and 1 for weekends. A timer is also necessary to activate the process outside the set hours. See the configuration below.

Interval 1

P3.12.1.1: ON Time: 07:00:00

P3.12.1.2: OFF Time: 17:00:00

P3.12.1.3: Days: Monday, Tuesday, Wednesday, Thursday, Friday

P3.12.1.4: Assign to channel: Time channel 1

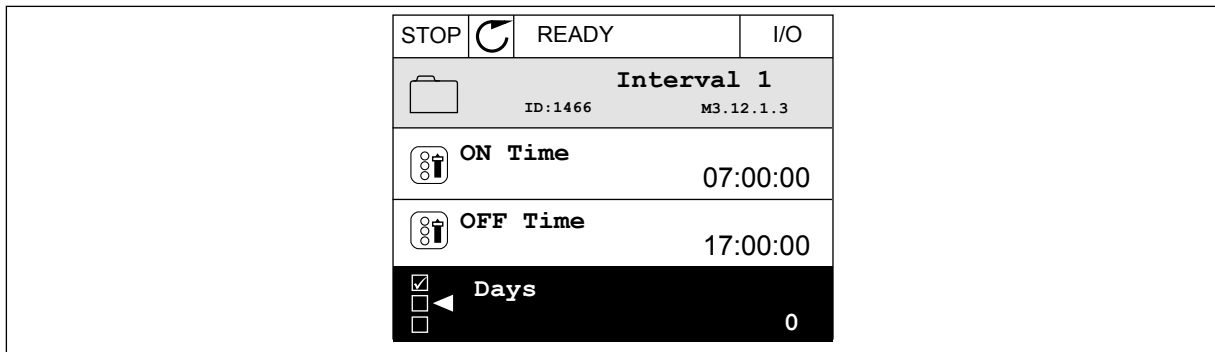

Fig. 76: Using timer functions to make an interval

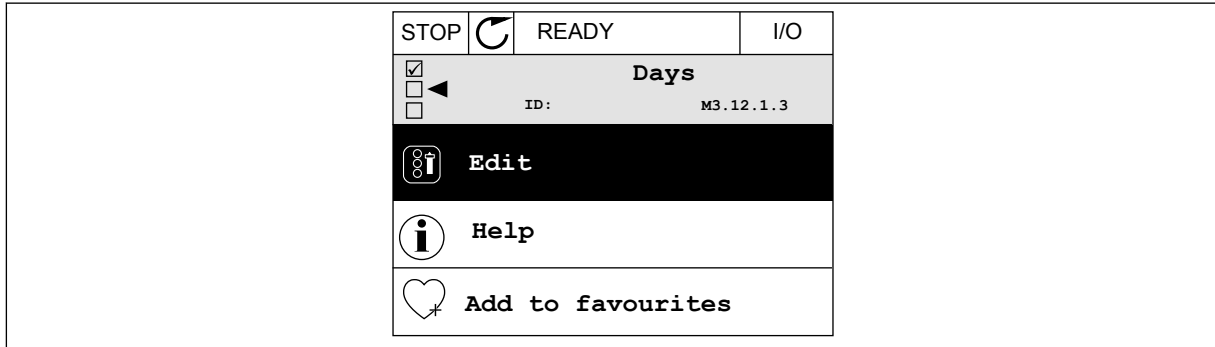

Fig. 77: Going into the Edit mode

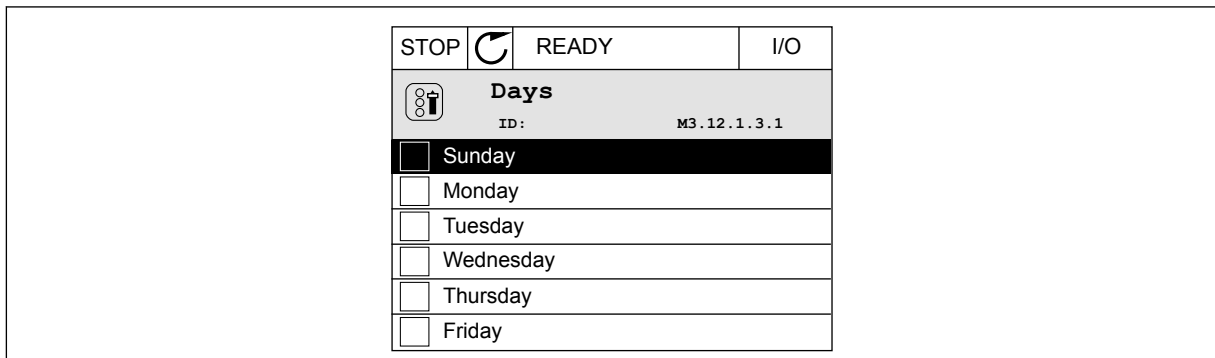

Fig. 78: The checkbox selection for the weekdays

Interval 2

- P3.12.2.1: ON Time: 09:00:00
- P3.12.2.2: OFF Time: 13:00:00
- P3.12.2.3: Days: Saturday, Sunday
- P3.12.2.4: Assign to channel: Time channel 1

Timer 1

- P3.12.6.1: Duration: 1800 s (30 min)
- P3.12.6.2: Timer 1: DigIn SlotA.1 (The parameter is located in the digital inputs menu.)
- P3.12.6.3: Assign to channel: Time channel 1
- P3.5.1.1: Control signal 1 A: Time Channel 1 for the I/O Run command

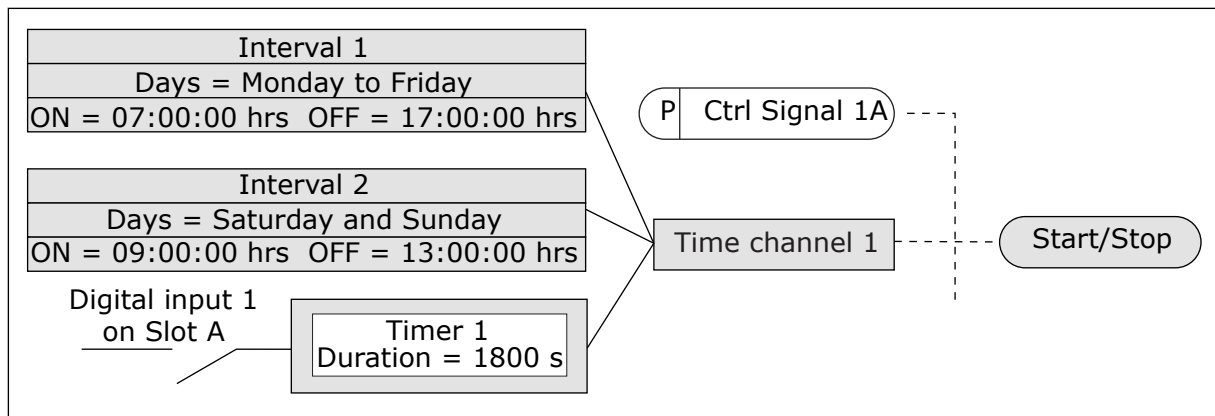

Fig. 79: Time channel 1 is used as the control signal for the start command instead of a digital input

P3.12.1.1 ON TIME (ID 1464)

Use this parameter to set the time of day when the output of the interval function is activated.

P3.12.1.2 OFF TIME (ID 1465)

Use this parameter to set the time of day when the output of the interval function is deactivated.

P3.12.1.3 DAYS (ID 1466)

Use this parameter to select the days of the week when the interval function is enabled.

P3.12.1.4 ASSIGN TO CHANNEL (ID 1468)

Use this parameter to select the time channel where the output of the interval function is assigned.

You can use the time channels to control the on/off type functions, for example relay outputs or any functions that can be controlled by a DI signal.

P3.12.6.1 DURATION (ID 1489)

Use this parameter to set the duration that the timer runs when the activation signal is removed (Off-delay).

P3.12.6.2 TIMER 1 (ID 447)

Use this parameter to select the digital input signal that starts the timer.

The output of the timer is activated when this signal is activated. The timer starts to count when this signal is deactivated (falling edge). The output is deactivated when the time that is set with the duration parameter has elapsed.

The rising edge starts Timer 1 that is programmed in Group 3.12.

P3.12.6.3 ASSIGN TO CHANNEL (ID 1490)

Use this parameter to select the time channel where the output of the timer function is assigned.

You can use the time channels to control the on/off type functions, for example relay outputs or any functions that can be controlled by a DI signal.

10.14 PID CONTROLLER

10.14.1 BASIC SETTINGS

P3.13.1.1 PID GAIN (ID 118)

Use this parameter to adjust the gain of the PID controller.
If this parameter is set to 100%, a change of 10% in the error value causes the controller output to change by 10%.

P3.13.1.2 PID INTEGRATION TIME (ID 119)

Use this parameter to adjust the integration time of the PID controller.
If this parameter is set to 1.00 s, a change of 10% in the error value causes the controller output to change by 10.00%/s.

P3.13.1.3 PID DERIVATION TIME (ID 132)

Use this parameter to adjust the derivation time of the PID controller.
If this parameter is set to 1.00 s, a change of 10% in the error value during 1.00 s causes the controller output to change by 10.00%.

P3.13.1.4 PROCESS UNIT SELECTION (ID 1036)

Use this parameter to select the unit for the feedback and the setpoint signals of the PID controller.
Make a selection of the unit for the actual value.

P3.13.1.5 PROCESS UNIT MIN (ID 1033)

Use this parameter to set the minimum value of the PID feedback signal.
For example, an analogue signal of 4...20 mA corresponds to the pressure of 0...10 bar. The value in process units at a 0% feedback or setpoint. This scaling is done for monitoring purposes only. The PID controller still uses the percentage internally for feedbacks and setpoints.

P3.13.1.6 PROCESS UNIT MAX (ID 1034)

Use this parameter to set the maximum value of the PID feedback signal.
For example, an analogue signal of 4...20 mA corresponds to the pressure of 0...10 bar. The value in process units at a 0% feedback or setpoint. This scaling is done for monitoring purposes only. The PID controller still uses the percentage internally for feedbacks and setpoints.

P3.13.1.7 PROCESS UNIT DECIMALS (ID 1035)

Use this parameter to set the number of decimals for the process unit values.
For example, an analogue signal of 4...20 mA corresponds to the pressure of 0...10 bar.

The value in process units at a 0% feedback or setpoint. This scaling is done for monitoring purposes only. The PID controller still uses the percentage internally for feedbacks and setpoints.

P3.13.1.8 ERROR INVERSION (ID 340)

Use this parameter to invert the error value of the PID controller.

P3.13.1.9 DEAD BAND (ID 1056)

Use this parameter to set the dead band area around the PID setpoint value.

The value of this parameter is given in the selected process unit. The output of the PID controller is locked if the feedback value stays in the dead band area for the set time.

P3.13.1.10 DEAD BAND DELAY (ID 1057)

Use this parameter to set the time that the feedback value must stay in the dead band area before the output of the PID controller is locked.

If the actual value stays in the dead band area for a time set in Dead Band Delay, the PID controller output is locked. This function prevents wear and unwanted movements of the actuators, for example valves.

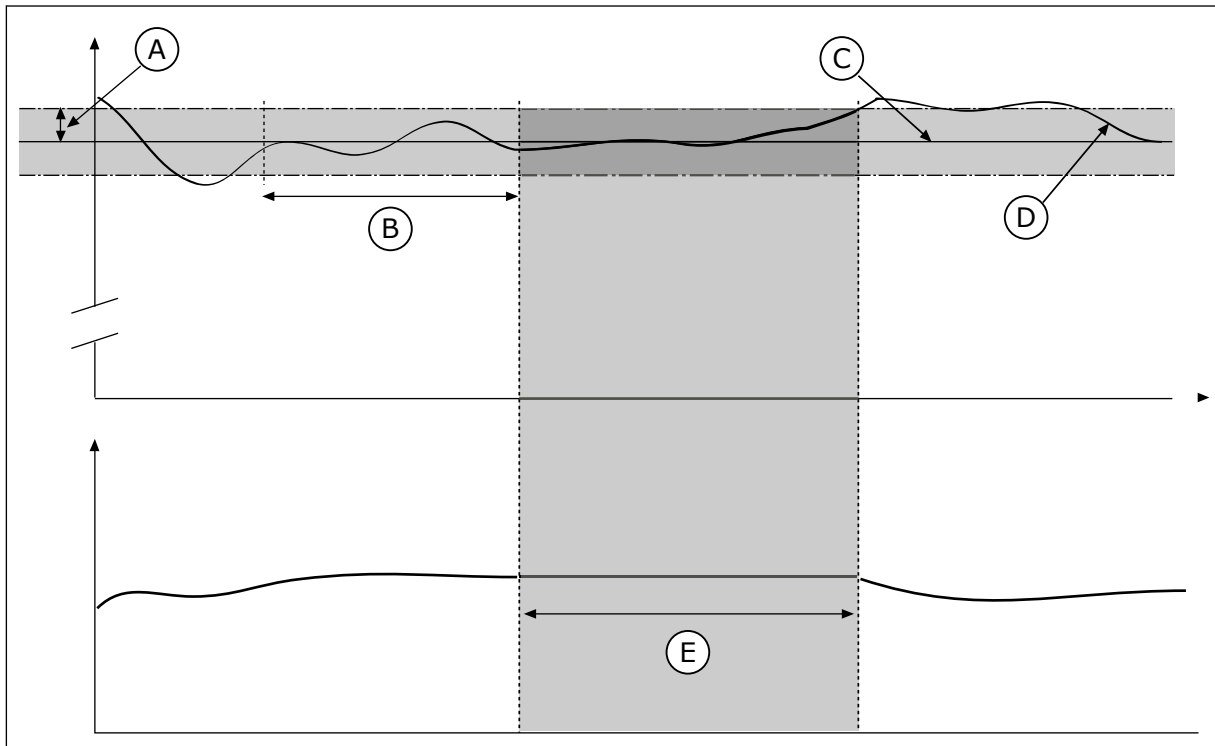

Fig. 80: The Dead band function

- | | |
|-----------------------------|------------------|
| A. Dead band (ID1056) | D. Actual value |
| B. Dead band delay (ID1057) | E. Output locked |
| C. Reference | |

10.14.2 SETPOINTS

P3.13.2.1 KEYPAD SETPOINT 1 (ID 167)

Use this parameter to set the setpoint value of the PID controller when the setpoint source is 'Keypad SP'.

The value of this parameter is given in the selected process unit.

P3.13.2.2 KEYPAD SETPOINT 2 (ID 168)

Use this parameter to set the setpoint value of the PID controller when the setpoint source is 'Keypad SP'.

The value of this parameter is given in the selected process unit.

P3.13.2.3 SETPOINT RAMP TIME (ID 1068)

Use this parameter to set the rising and falling ramp times for the setpoint changes.

Ramp time is the time that is necessary for the setpoint value to change from minimum to maximum. If the value of this parameter is set to 0, no ramps are used.

P3.13.2.4 PID SETPOINT BOOST ACTIVATION (ID 1046)

Use this parameter to select the digital input signal that activates the boost for the PID setpoint value.

P3.13.2.5 PID SETPOINT SELECTION (ID 1047)

Use this parameter to set the digital input signal that selects the PID setpoint value to be used.

P3.13.2.6 SETPOINT SOURCE 1 SELECTION (ID 332)

Use this parameter to select the source of the PID setpoint signal.

The AIs and the ProcessDataIn are handled as percentages (0.00-100.00%) and scaled according to the setpoint minimum and maximum.



NOTE!

The ProcessDataIn signals use 2 decimals.

If temperature inputs are selected, you must set the values of parameters P3.13.1.5 Process Unit Min and P3.13.1.6 Process Unit Max to correspond to the the scale of the temperature measurement board: ProcessUnitMin = -50 °C and ProcessUnitMax = 200 °C.

P3.13.2.7 SETPOINT 1 MINIMUM (ID 1069)

Use this parameter to set the minimum value of the setpoint signal.

P3.13.2.8 SETPOINT 1 MAXIMUM (ID 1070)

Use this parameter to set the maximum value of the setpoint signal.

P3.13.2.9 SETPOINT 1 BOOST (ID 1071)

Use this parameter to set the multiplier for the setpoint boost function. When the setpoint boost command is given, the setpoint value is multiplied with the factor that is set with this parameter.

10.14.3 FEEDBACK**P3.13.3.1 FEEDBACK FUNCTION (ID 333)**

Use this parameter to select if the feedback value is taken from a single signal or combined from two signals.

You can select the mathematical function that is used when the two feedback signals are combined.

P3.13.3.2 FEEDBACK FUNCTION GAIN (ID 1058)

Use this parameter to adjust the gain of the feedback signal. This parameter is used, for example, with the value 2 in Feedback Function.

P3.13.3.3 FEEDBACK 1 SOURCE SELECTION (ID 334)

Use this parameter to select the source of the PID feedback signal. The Als and the ProcessDataIn are handled as percentages (0.00-100.00%) and scaled according to the feedback minimum and maximum.

**NOTE!**

The ProcessDataIn signals use 2 decimals.

If temperature inputs are selected, you must set the values of parameters P3.13.1.5 Process Unit Min and P3.13.1.6 Process Unit Max to correspond to the the scale of the temperature measurement board: ProcessUnitMin = -50 °C and ProcessUnitMax = 200 °C.

P3.13.3.4 FEEDBACK 1 MINIMUM (ID 336)

Use this parameter to set the minimum value of the feedback signal.

P3.13.3.5 FEEDBACK 1 MAXIMUM (ID 337)

Use this parameter to set the maximum value of the feedback signal.

10.14.4 FEEDFORWARD**P3.13.4.1 FEEDFORWARD FUNCTION (ID 1059)**

Use this parameter to select if the feedforward value is taken from a single signal or combined from two signals.

You can select the mathematical function that is used when the two feedforward signals are combined.

Accurate process models are usually necessary for the Feedforward function. In some conditions, a gain and offset type of feedforward is sufficient. The feedforward part does not

use the feedback measurements of the actual controlled process value. The feedforward control uses other measurements that have an effect on the controlled process value.

EXAMPLE 1:

You can control the water level of a tank with flow control. The target water level is set as a setpoint, and the actual level as feedback. The control signal monitors the flow that comes in.

The outflow is like a disturbance that you can measure. With the measurements of the disturbance, you can try to adjust this disturbance with a feedforward control (gain and offset) that you add to the PID output. The PID controller reacts much faster to changes in the outflow than if you only measure the level.

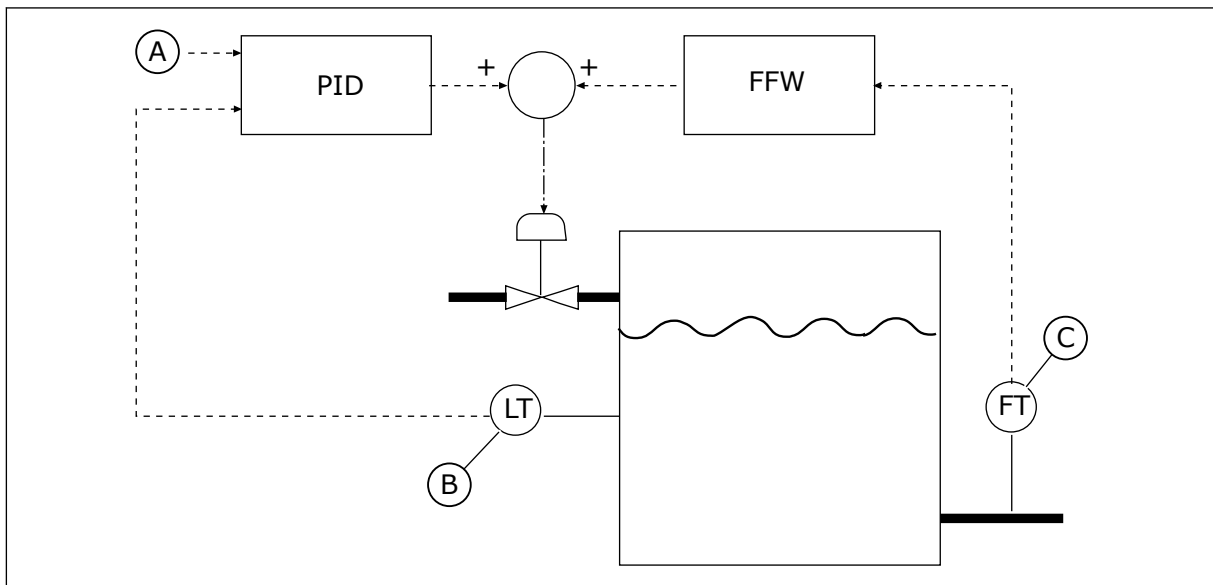

Fig. 81: The feedforward control

A. Level ref
B. Level control

C. Outflow control

P3.13.4.2 FEEDFORWARD GAIN (ID 1060)

Use this parameter to adjust the gain of the feedforward signal.

P3.13.4.3 FEEDFORWARD 1 SOURCE SELECTION (ID 1061)

Use this parameter to select the source of the PID feedforward signal.

P3.13.4.4 FEEDFORWARD 1 MINIMUM (ID 1062)

Use this parameter to set the minimum value of the feedforward signal.

P3.13.4.5 FEEDFORWARD 1 MAXIMUM (ID 1063)

Use this parameter to set the maximum value of the feedforward signal.

10.14.5 SLEEP FUNCTION

P3.13.5.1 SP1 SLEEP FREQUENCY (ID 1016)

Use this parameter to set the limit below which the output frequency of the drive must stay for a set time before the drive goes to the sleep state.

The value of this parameter is used when the signal of the PID controller setpoint is taken from the setpoint source 1.

Criteria for going to sleep mode

- Output frequency remains below sleep frequency for longer than defined sleep delay time
- PID feedback signal remains above defined wake up level

Criteria for waking from sleep

- PID feedback signal falls below defined wake up level



NOTE!

A wrong set wake up level might not allow the drive to go into sleep mode

P3.13.5.2 SP1 SLEEP DELAY (ID 1017)

Use this parameter to set the minimum duration that the output frequency of the drive must stay below the set limit before the drive goes to the sleep state.

The value of this parameter is used when the signal of the PID controller setpoint is taken from the setpoint source 1.

P3.13.5.3 SP1 WAKE-UP LEVEL (ID 1018)

Use this parameter to set the level at which the drive wakes up from the sleep state. When the PID feedback value goes below the level that is set with this parameter, drive wakes up from the sleep state. The operation of this parameter is selected with wake up mode parameter.

P3.13.5.4 SP1 WAKE-UP MODE (ID 1019)

Use this parameter to select the operation for the wake up level parameter.

The drive wakes up from the sleep mode when the value of PID Feedback goes below the Wake-up level.

This parameter defines if Wake-up level is used as a static absolute level or as a relative level which follows PID setpoint value.

Selection 0 = Absolute level (The wake-up level is a static level that does not follow the setpoint value.)

Selection 1 = Relative setpoint (The wake-up level is an offset below the actual setpoint value. The wake-up level follows the actual setpoint.)

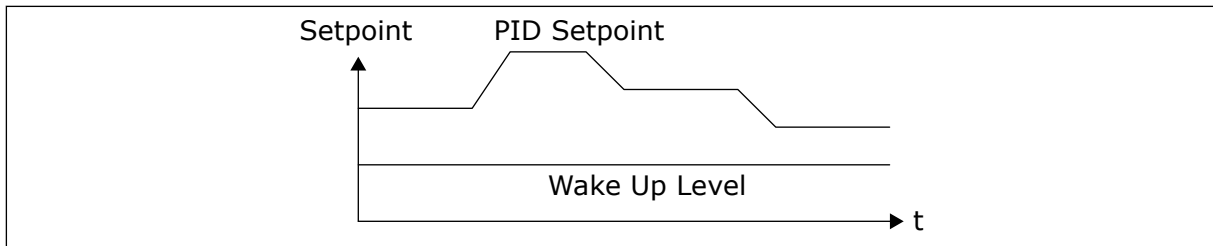

Fig. 82: Wake-up Mode: absolute level

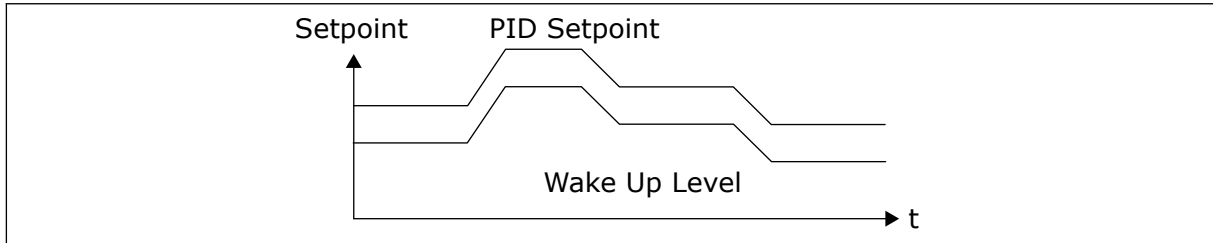

Fig. 83: Wake-up Mode: relative setpoint

P3.13.5.5 SP1 SLEEP BOOST (ID 1793)

Use this parameter to set the value that is added to the actual setpoint value when the sleep boost function is used.

Before the drive goes to the sleep state, the PID regulation setpoint increases automatically, which gives a higher process value. The sleep state is longer, also when there is some moderate leakage.

The boost level is used when there is a frequency threshold and delay, and the drive goes to the sleep state. After the increment in the setpoint by the actual value, the boost increment of the setpoint is erased and the drive goes to the sleep state and the motor stops. The boost increment is positive with the direct PID regulation (P3.13.1.8 = Normal) and negative with the reverse PID regulation (P3.13.1.8 = Inverted).

If the actual value does not go to the increment setpoint, the boost value is erased after the time set with P3.13.5.5. The drive goes to the normal regulation with the normal setpoint.

In a Multi-pump setup, if an auxiliary pump starts during the boost, the boost sequence stops and the normal regulation continues.

P3.13.5.6 SP1 SLEEP BOOST MAXIMUM TIME (ID 1795)

Use this parameter to set the timeout time for the sleep boost function.

P3.13.5.7 SP2 SLEEP FREQUENCY (ID 1075)

Use this parameter to set the limit below which the output frequency of the drive must stay for a set time before the drive goes to the sleep state.

P3.13.5.8 SP2 SLEEP DELAY (ID 1076)

Use this parameter to set the minimum duration that the output frequency of the drive must stay below the set limit before the drive goes to the sleep state.

P3.13.5.9 SP2 WAKE UP LEVEL (ID 1077)

Use this parameter to set the level at which the drive wakes up from the sleep state.

P3.13.5.10 SP2 WAKE UP MODE (ID 1020)

Use this parameter to select the operation for the wake up level parameter.

P3.13.5.11 SP2 SLEEP BOOST (ID 1794)

Use this parameter to set the value that is added to the actual setpoint value when the sleep boost function is used.

P3.13.5.12 SP2 SLEEP BOOST MAXIMUM TIME (ID 1796)

Use this parameter to set the timeout time for the sleep boost function.

10.14.6 FEEDBACK SUPERVISION

Use the feedback supervision to make sure that the PID Feedback value (the process value or the actual value) stays in the set limits. With this function you can, for example, find a pipe break and stop the flooding.

These parameters set the range in which the PID Feedback signal stays in correct conditions. If the PID Feedback signal does not stay in the range, and this continues longer than the delay, a Feedback supervision fault (the fault code 101) shows.

P3.13.6.1 ENABLE FEEDBACK SUPERVISION (ID 735)

Use this parameter to enable the feedback supervision function.

Use the feedback supervision to make sure that the PID feedback value stays in the set limits.

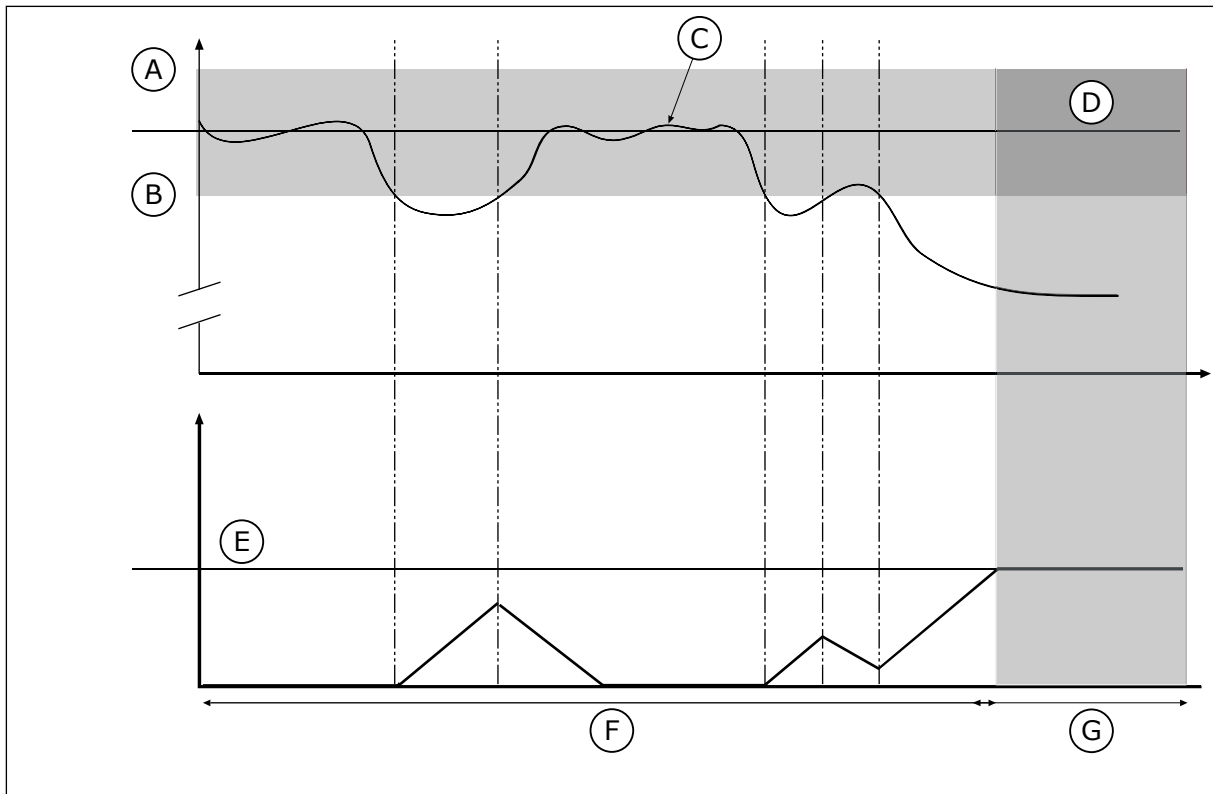

Fig. 84: The Feedback supervision function

- | | |
|------------------------|--------------------|
| A. Upper limit (ID736) | E. Delay (ID737) |
| B. Lower limit (ID758) | F. Regulating mode |
| C. Actual value | G. Alarm or fault |
| D. Reference | |

P3.13.6.2 UPPER LIMIT (ID 736)

Use this parameter to set the high limit for the PID feedback signal. If the value of the PID feedback signal goes above this limit for longer than the set time, a feedback supervision fault occurs.

P3.13.6.3 LOWER LIMIT (ID 758)

Use this parameter to set the low limit for the PID feedback signal. If the value of the PID feedback signal goes below this limit for longer than the set time, a feedback supervision fault occurs. Set the upper limit and the lower limit around the reference. When the actual value is less or more than the limits, a counter starts to count up. When the actual value is between the limits, the counter counts down. When the counter gets a value that is higher than the value of P3.13.6.4 Delay, an alarm or a fault shows. You can make a selection of the response with parameter P3.13.6.5 (Response to PID1 Supervision Fault).

P3.13.6.4 DELAY (ID 737)

Use this parameter to set the maximum time for the PID feedback signal to stay outside the supervision limits before the feedback supervision fault occurs. If the target value is not reached in this time, a fault or alarm shows.

P3.13.6.5 RESPONSE TO PID SUPERVISION FAULT (ID 749)

Use this parameter to select the response of the drive to a 'PID Supervision' fault. If the PID feedback value is not in the supervision limits for longer than the supervision delay, a PID supervision fault occurs.

10.14.7 PRESSURE LOSS COMPENSATION

When you pressurise a long pipe that has many outlets, the best position for the sensor is in the middle of the pipe (the position 2 in the figure). You can also put the sensor directly after the pump. This gives the right pressure directly after the pump, but farther in the pipe, the pressure drops with the flow.

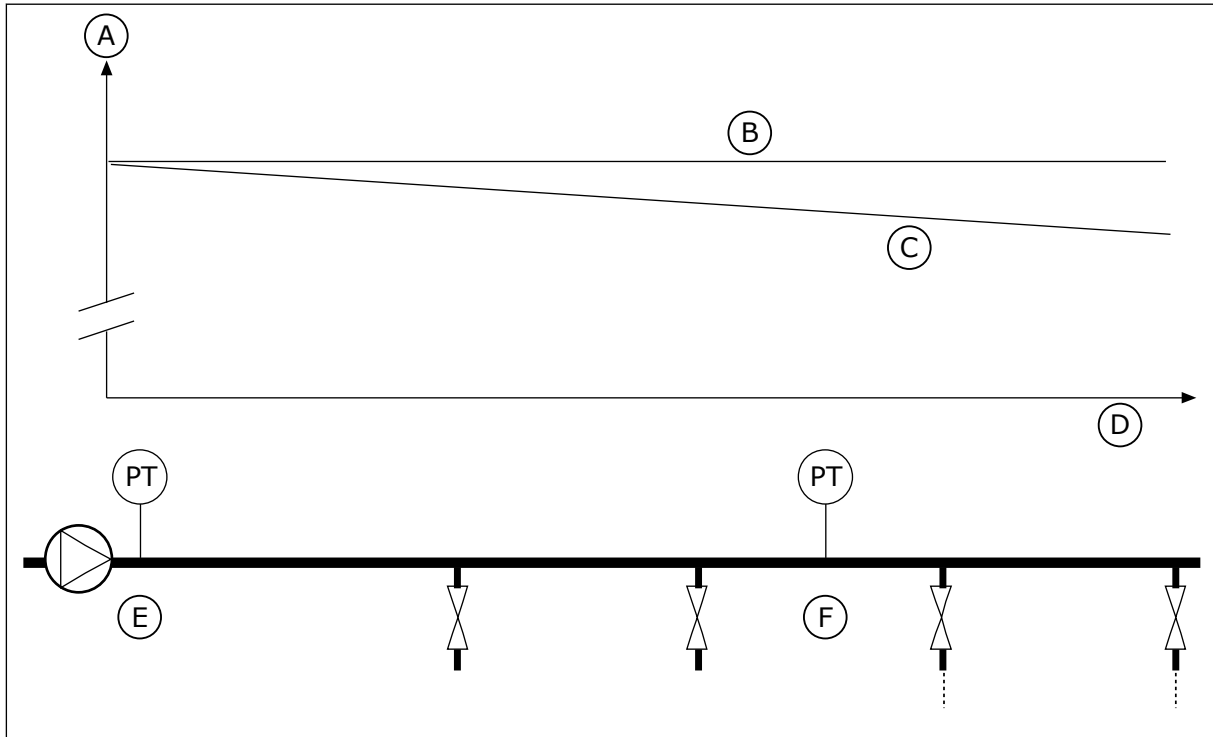

Fig. 85: The position of the pressure sensor

- | | |
|--------------|----------------|
| A. Pressure | D. Pipe length |
| B. No flow | E. Position 1 |
| C. With flow | F. Position 2 |

P3.13.7.1 ENABLE SETPOINT 1 (ID 1189)

Use this parameter to enable the pressure loss compensation in the pump system. In a pressure controlled system, this function compensates the pressure loss that occurs at the end of the pipe line due to the liquid flow.

P3.13.7.2 SETPOINT 1 MAX COMPENSATION (ID 1190)

Use this parameter to set the maximum compensation for PID setpoint value that is applied when the output frequency of the drive is at the maximum frequency.

The compensation value is added to the actual setpoint value as a function of the output frequency.

Setpoint compensation = max compensation * (FreqOut-MinFreq)/(MaxFreq-MinFreq).

The sensor is put in position 1. The pressure in the pipe stays constant when there is no flow. But with flow, the pressure decreases farther in the pipe. To compensate for this, lift the setpoint as the flow increases. Then the output frequency makes an estimate of the flow, and the setpoint increases linearly with the flow.

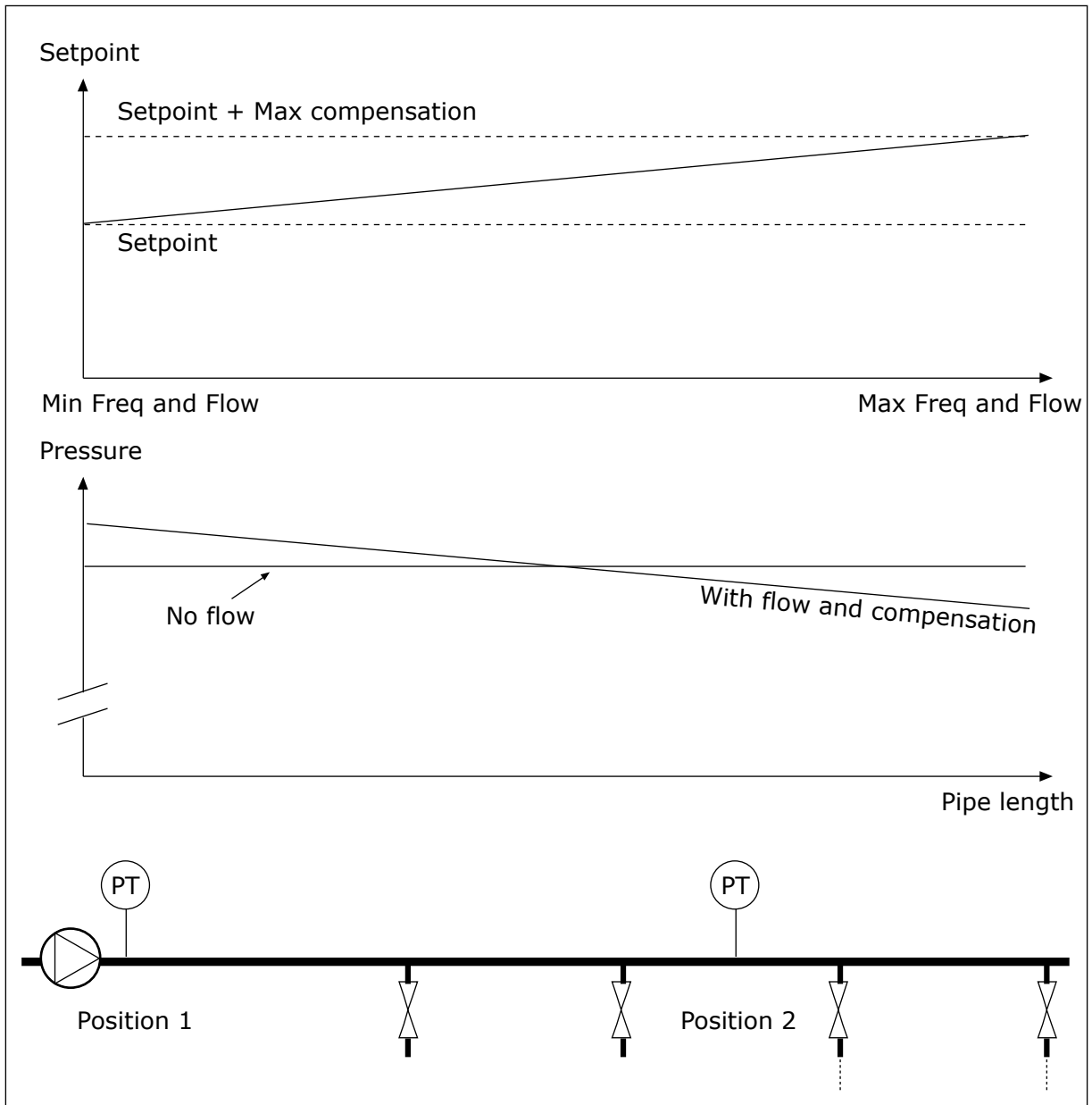

Fig. 86: Enable setpoint 1 for pressure loss compensation

10.14.8 SOFT FILL

The Soft fill function is used to move the process to a set level at a slow speed before the PID controller starts to control. If the process does not go to the set level during the timeout, a fault shows.

You can use the function to fill an empty pipe slowly and prevent strong currents of water that could break the pipe.

We recommend that you always use the Soft fill function when you use the Multi-pump function.

P3.13.8.1 SOFT FILL FUNCTION (ID 1094)

Use this parameter to enable the Soft Fill function. You can use the function to fill an empty pipe slowly and prevent strong currents of fluid that could break the pipe.

Table 122: Selection table

Selection number	Selection name	Description
0	Disabled	
1	Enabled (Level)	The drive operates at a constant frequency (P3.13.8.2 Soft Fill Frequency) until the PID feedback signal goes to the soft fill level (P3.13.8.3 Soft Fill Level). The PID controller starts the regulation. In addition, if the PID feedback signal does not go to the soft fill level in the soft fill timeout (P3.13.8.4 Soft Fill Timeout), a soft fill fault shows (P3.13.8.4 Soft Fill Timeout is set to greater than 0). The soft fill mode is used in vertical installations.
2	Enabled (Timeout)	The drive operates at a constant frequency (P3.13.8.2 Soft Fill Frequency) until the soft fill time (P3.13.8.4 Soft Fill Timeout) goes. After the soft fill time, the PID controller starts the regulation. In this mode, the soft fill fault is not available. The soft fill mode is used in horizontal installations.

P3.13.8.2 SOFT FILL FREQUENCY (ID 1055)

Use this parameter to set the frequency reference of the drive when the Soft Fill function is used.

P3.13.8.3 SOFT FILL LEVEL (ID 1095)

Use this parameter to set the level below which the soft fill control is enabled when starting the drive.

The drive operates at the PID start frequency until the feedback reaches the set value. Then the PID controller starts to control the drive.

This parameter is applied if the soft fill function is set to 'Enabled (Level)'.

P3.13.8.4 SOFT FILL TIMEOUT (ID 1096)

Use this parameter to set the timeout time for the Soft Fill function. When the soft fill function is set to *Enabled (Level)*, this parameter gives the timeout for the soft fill level, after which the soft fill fault occurs. When the soft fill function is set to 'Enabled, Timeout', the drive operates at the soft fill frequency until the time set by this parameter expires.

If you selected the option *Enabled (Timeout)* in parameter P3.13.8.1 Soft Fill Function, parameter Soft Fill Timeout gives the quantity of time that the drive operates at the constant

soft fill frequency (P3.13.8.2 Soft Fill Frequency) before the PID controller starts the regulation.

P3.13.8.5 SOFT FILL FAULT (ID 748)

Use this parameter to select the response of the drive to a PID Soft Fill fault. If the PIDFeedback value does not reach the set level in the time limit, a soft fill fault occurs.

- 0 = No action
- 1 = Alarm
- 2 = Fault (stop according to stop mode)
- 3 = Fault (stop by coasting)

10.14.9 INPUT PRESSURE SUPERVISION

Use the Input pressure supervision to make sure that there is enough water in the inlet of the pump. When there is enough water, the pump does not suck air and there is no suction cavitation. To use the function, install a pressure sensor on the pump inlet.

If the input pressure of the pump goes below the set alarm limit, an alarm shows. The setpoint value of the PID controller decreases and causes the output pressure of the pump to decrease. If the pressure goes below the fault limit, the pump is stops and a fault shows.

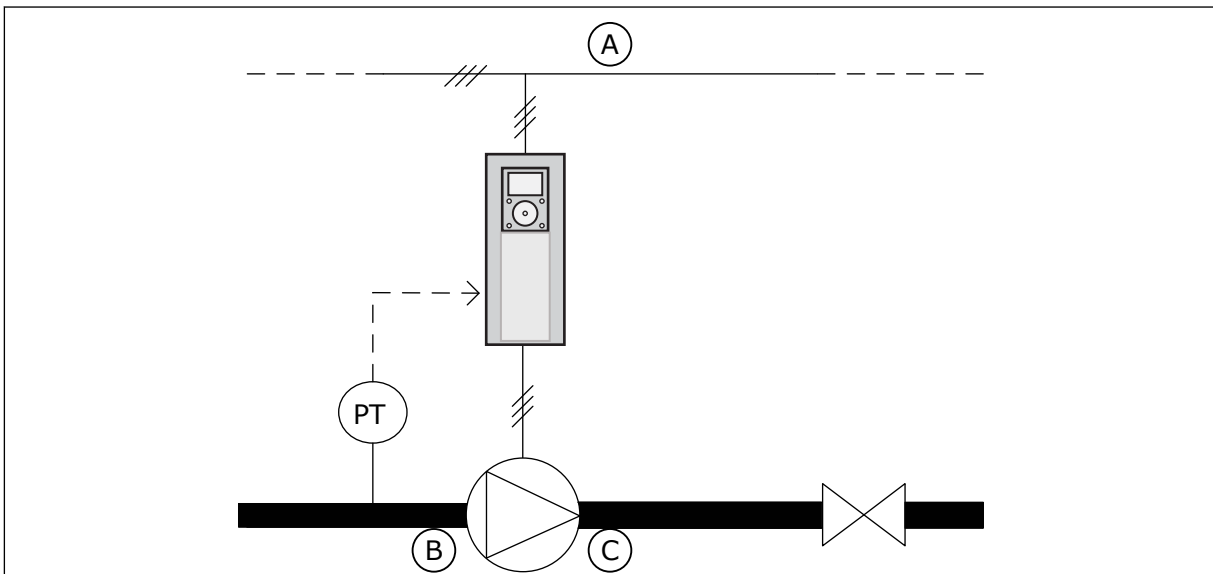

Fig. 87: The location of the pressure sensor

- A. Mains
- B. Inlet

C. Outlet

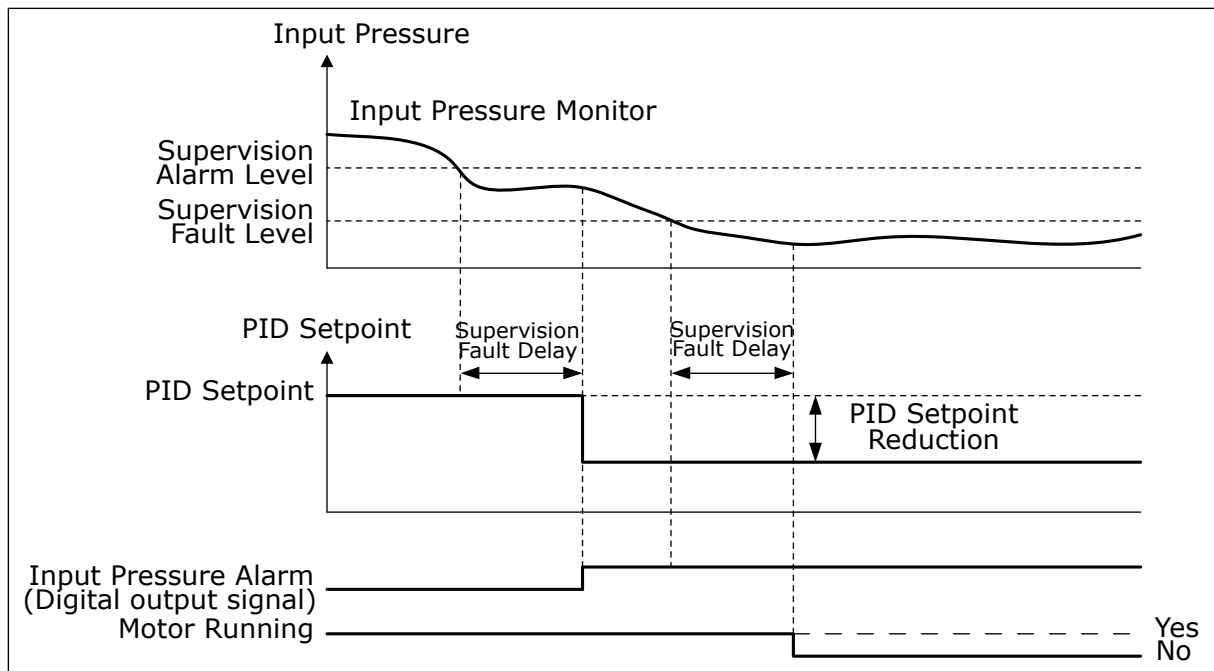

Fig. 88: The Input pressure supervision function

P3.13.9.1 ENABLE SUPERVISION (ID 1685)

Use this parameter to enable the Input Pressure Supervision function.
Use this function to make sure that there is enough fluid in the inlet of the pump.

P3.13.9.2 SUPERVISION SIGNAL (ID 1686)

Use this parameter to select the source of the input pressure signal.

P3.13.9.3 SUPERVISION UNIT SELECTION (ID 1687)

Use this parameter to select the unit for the input pressure signal.
You can scale the supervision signal (P3.13.9.2) to process units on the panel.

P3.13.9.4 SUPERVISION UNIT DECIMALS (ID 1688)

Use this parameter to set the number of decimals for the input pressure signal unit.
You can scale the supervision signal (P3.13.9.2) to process units on the panel.

P3.13.9.5 SUPERVISION UNIT MINIMUM VALUE (ID 1689)

Use this parameter to set the minimum value of the input pressure signal.
Enter the value in the selected process unit. For example, an analogue signal of 4...20 mA corresponds to the pressure of 0...10 bar.

P3.13.9.6 SUPERVISION UNIT MAXIMUM VALUE (ID 1690)

Use this parameter to set the maximum value of the input pressure signal.
Enter the value in the selected process unit. For example, an analogue signal of 4...20 mA corresponds to the pressure of 0...10 bar.

P3.13.9.7 SUPERVISION ALARM LEVEL (ID 1691)

Use this parameter to set the limit for the input pressure alarm.
If the measured input pressure goes below this limit, an input pressure alarm occurs.

P3.13.9.8 SUPERVISION FAULT LEVEL (ID 1692)

Use this parameter to set the limit for the input pressure fault.
If the measured input pressure stays below this level for longer than the set time, an input pressure fault occurs.

P3.13.9.9 SUPERVISION FAULT DELAY (ID 1693)

Use this parameter to set the maximum duration for the input pressure to stay below the fault limit before an input pressure fault occurs.

P3.13.9.10 PID SETPOINT REDUCTION (ID 1694)

Use this parameter to set the rate of the reduction of the PID setpoint value when the measured input pressure is below the alarm limit.

10.14.10 SLEEP FUNCTION WHEN NO DEMAND IS DETECTED

This function makes sure that the pump does not operate at a high speed when there is no demand in the system.

The function becomes active when the PID feedback signal and the output frequency of the drive stay in the specified hysteresis areas for longer than set with parameter P3.13.10.4 SNDD Supervision Time.

There are different hysteresis settings for the PID feedback signal and the output frequency. The hysteresis for the PID feedback (SNDD Error Hysteresis P3.13.10.2) is given in the selected process units around the PID setpoint value.

When the function is active, a short-time bias value (SNDD Actual Add) is added internally to the feedback value.

- If there is no demand in the system, the PID output and the output frequency of the drive decrease to the direction of 0. If the PID feedback value stays in the hysteresis area, the drive goes to the Sleep mode.
- If the PID feedback value does not stay in the hysteresis area, the function is deactivated and the drive continues to operate.

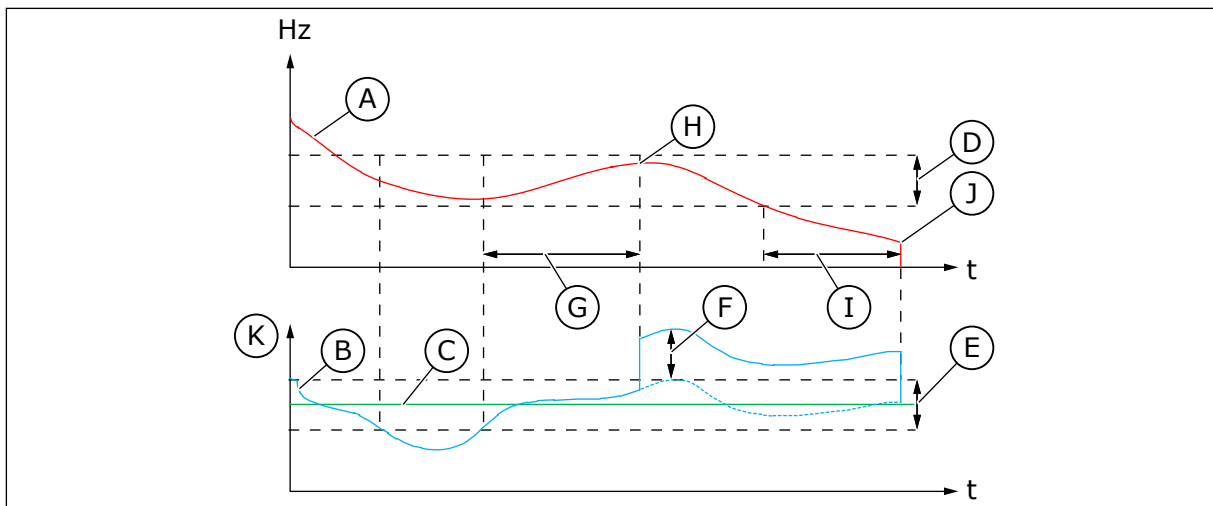

Fig. 89: Sleep, no demand detected

- | | |
|---|--|
| A. The output frequency of the drive | H. The PID feedback value and the output frequency of the drive are in the hysteresis areas for the set time (SNDD Supervision Time). A bias value (SNDD Actual Add) is added to the PID feedback value. |
| B. The PID feedback value | I. SP1 Sleep Delay Time (P3.13.5.2) |
| C. The PID setpoint value | J. The drive goes to the Sleep mode. |
| D. SNDD Frequency Hysteresis (P3.13.10.3) | K. Process Unit (P3.13.1.4) |
| E. SNDD Error Hysteresis (P3.13.10.2)
The hysteresis area around the PID setpoint value. | |
| F. SNDD Actual Add (P3.13.10.5) | |
| G. SNDD Supervision Time (P3.13.10.4) | |

P3.13.10.1 SLEEP NO DEMAND DETECTION ENABLE (ID 1649)

Use this parameter to activate the Sleep No Demand Detection (SNDD) function.

P3.13.10.2 SNDD ERROR HYSTERESIS (ID 1658)

Use this parameter to set the hysteresis for the error value of the PID controller.

P3.13.10.3 SNDD FREQUENCY HYSTERESIS (ID 1663)

Use this parameter to set the hysteresis for the output frequency of the drive.

P3.13.10.4 SNDD SUPERVISION TIME (ID 1668)

Use this parameter to set the time that the output frequency of the drive and the error value of the PID controller must stay in the hysteresis areas before the SNDD function becomes active.

P3.13.10.5 SNDD ACTUAL ADD (ID 1669)

Use this parameter to set the value that is added to the actual value of the PID feedback for a short time when the SNDD function is active.

10.14.11 MULTI-SETPOINT

P3.13.12.1 MULTI-SETPOINT 0 (ID 15560)

Use this parameter to set the preset PID setpoint value when the Multi-setpoint function is used. Make the selection of the multi-setpoint with the digital input signals.

P3.13.12.2 MULTI-SETPOINT 1 (ID 15561)

Use this parameter to set the preset PID setpoint value when the Multi-setpoint function is used. Make the selection of the multi-setpoint with the digital input signals.

P3.13.12.3 MULTI-SETPOINT 2 (ID 15562)

Use this parameter to set the preset PID setpoint value when the Multi-setpoint function is used. Make the selection of the multi-setpoint with the digital input signals.

P3.13.12.4 MULTI-SETPOINT 3 (ID 15563)

Use this parameter to set the preset PID setpoint value when the Multi-setpoint function is used. Make the selection of the multi-setpoint with the digital input signals.

P3.13.12.5 MULTI-SETPOINT 4 (ID 15564)

Use this parameter to set the preset PID setpoint value when the Multi-setpoint function is used. Make the selection of the multi-setpoint with the digital input signals.

P3.13.12.6 MULTI-SETPOINT 5 (ID 15565)

Use this parameter to set the preset PID setpoint value when the Multi-setpoint function is used. Make the selection of the multi-setpoint with the digital input signals.

P3.13.12.7 MULTI-SETPOINT 6 (ID 15566)

Use this parameter to set the preset PID setpoint value when the Multi-setpoint function is used. Make the selection of the multi-setpoint with the digital input signals.

P3.13.12.8 MULTI-SETPOINT 7 (ID 15567)

Use this parameter to set the preset PID setpoint value when the Multi-setpoint function is used. Make the selection of the multi-setpoint with the digital input signals.

P3.13.12.9 MULTI-SETPOINT 8 (ID 15568)

Use this parameter to set the preset PID setpoint value when the Multi-setpoint function is used. Make the selection of the multi-setpoint with the digital input signals.

P3.13.12.10 MULTI-SETPOINT 9 (ID 15569)

Use this parameter to set the preset PID setpoint value when the Multi-setpoint function is used. Make the selection of the multi-setpoint with the digital input signals.

P3.13.12.11 MULTI-SETPOINT 10 (ID 15570)

Use this parameter to set the preset PID setpoint value when the Multi-setpoint function is used. Make the selection of the multi-setpoint with the digital input signals.

P3.13.12.12 MULTI-SETPOINT 11 (ID 15571)

Use this parameter to set the preset PID setpoint value when the Multi-setpoint function is used. Make the selection of the multi-setpoint with the digital input signals.

P3.13.12.13 MULTI-SETPOINT 12 (ID 15572)

Use this parameter to set the preset PID setpoint value when the Multi-setpoint function is used. Make the selection of the multi-setpoint with the digital input signals.

P3.13.12.14 MULTI-SETPOINT 13 (ID 15573)

Use this parameter to set the preset PID setpoint value when the Multi-setpoint function is used. Make the selection of the multi-setpoint with the digital input signals.

P3.13.12.15 MULTI-SETPOINT 14 (ID 15574)

Use this parameter to set the preset PID setpoint value when the Multi-setpoint function is used. Make the selection of the multi-setpoint with the digital input signals.

P3.13.12.16 MULTI-SETPOINT 15 (ID 15575)

Use this parameter to set the preset PID setpoint value when the Multi-setpoint function is used. Make the selection of the multi-setpoint with the digital input signals.

P3.13.12.17 MULTI-SETPOINT SELECTION 0 (ID 15576)

Use this parameter to select the digital input signal that is used as a selector for the PID Multi-setpoint function.

P3.13.12.18 MULTI-SETPOINT SELECTION 1 (ID 15577)

Use this parameter to select the digital input signal that is used as a selector for the PID Multi-setpoint function.

P3.13.12.19 MULTI-SETPOINT SELECTION 2 (ID 15578)

Use this parameter to select the digital input signal that is used as a selector for the PID Multi-setpoint function.

P3.13.12.20 MULTI-SETPOINT SELECTION 3 (ID 15579)

Use this parameter to select the digital input signal that is used as a selector for the PID Multi-setpoint function.

10.15 EXTERNAL PID CONTROLLER

P3.14.1.1 ENABLE EXTERNAL PID (ID 1630)

Use this parameter to enable the PID controller.



NOTE!

This controller is for external use only. It can be used with an analogue output.

P3.14.1.2 START SIGNAL (ID 1049)

Use this parameter to set the signal for starting and stopping the PID controller 2 for external usage.



NOTE!

If the PID2 controller is not enabled in the Basic menu for PID2, this parameter has no effect.

P3.14.1.3 OUTPUT IN STOP (ID 1100)

Use this parameter to set the output value of the PID controller as a percentage of its maximum output value when it is stopped from a digital output.

If the value of this parameter is set to 100%, a 10% change in the error value causes a 10% change in the controller output.

10.16 MULTI-PUMP FUNCTION

The Multi-pump function lets you control a system where the maximum of 8 motors, for example, pumps, fans or compressors operate in parallel. The internal PID controller of the drive operates the necessary quantity of motors and controls the speed of the motors, when there is demand.

10.16.1 MULTI-PUMP (MULTIDRIVE) COMMISSIONING CHECKLIST

The check list helps you in the configuration of the basic settings of the Multi-pump (multidrive) system. If you use the keypad for parametrisation, the application wizard helps you to make the basic settings.

Start the commissioning with the drives that have the PID feedback signal (pressure sensor, for example) connected to an analogue input (default: AI2). Go through all the drives in the system.

Step	Action
1	<p>Examine the wiring.</p> <ul style="list-style-type: none"> • See the correct power cabling (mains cable, motor cable) of the drive in <i>Installation Manual</i>. • See the correct control cabling (I/O, PID feedback sensor, communication) in <i>Fig. 18 Electric wiring diagramme of the Multi-pump (multidrive) system, example 1A</i> and in <i>Fig. 16 The default control connections of Multi-pump (multidrive) application</i>. • If redundancy is necessary, make sure that the PID feedback signal (by default: AI2) is connected to a minimum of 2 drives. See the wiring instructions in <i>Fig. 18 Electric wiring diagramme of the Multi-pump (multidrive) system, example 1A</i>.
2	<p>Do a power-up of the drive and start the parametrisation.</p> <ul style="list-style-type: none"> • Start the parametrisation with the drives that have the PID feedback signal connected. These drives can operate as the master of the Multi-pump system. • You can do the parametrisation with the keypad or PC the tool.
3	<p>Select the Multi-pump (multidrive) application configuration with parameter P1.2.</p> <ul style="list-style-type: none"> • Most of the Multi-pump-related settings and configurations are made automatically, when the Multi-pump (multidrive) application is selected with parameter P1.2 Application (ID 212). See <i>2.5 Multi-pump (multidrive) application wizard</i>. • If you use the keypad for the parametrisation, the Application wizard starts when parameter P1.2 Application (ID 212) is changed. The Application wizard helps you with Multi-pump-related questions.
4	<p>Set the motor parameters.</p> <ul style="list-style-type: none"> • Set the motor nameplate parameters specified by the rating plate of the motor.
5	<p>Set the total number of drives used in the Multi-pump system.</p> <ul style="list-style-type: none"> • This value is set with parameter P1.35.14 Quick Setup Parameter Menu. • The same parameter is in the menu Parameters -> Group 3.15 -> P3.15.2 • By default, the Multi-pump system has 3 pumps (drives).
6	<p>Select the signals that are connected to the drive.</p> <ul style="list-style-type: none"> • Go to parameter P1.35.16 (Quick Setup Parameter Menu). • The same parameter is in the menu Parameters -> Group 3.15 -> P3.15.4. • If the PID feedback signal is connected, the drive can operate as the master of the Multi-pump system. If the signal is not connected, the drive operates as a slave unit. • Select <i>Signals connected</i>, if the start and the PID feedback signals (the pressure sensor, for example) are connected to the drive. • Select <i>Start signal only</i>, if only the start signal is connected to the drive (the PID feedback signal is not connected). • Select <i>Not connected</i>, if the start or the PID feedback signals are not connected to the drive.

Step	Action
7	<p>Set the ID number of the pump.</p> <ul style="list-style-type: none"> Go to parameter P1.35.15 (Quick Setup Parameter Menu). The same parameter is in the menu Parameters -> Group 3.15 -> P3.15.3. Each drive in the Multi-pump system must have an ID number that no other drive has for the correct communication between drives. The ID numbers must be in a numerical order and start from number 1. The drives, which have a PID feedback signal connected, have the smallest ID numbers (for example, ID 1 and ID 2). This gives the shortest possible start-up delay when you do a power-up of the system.
8	<p>Configure the Interlock function.</p> <ul style="list-style-type: none"> Go to parameter P1.35.17 (Quick Setup Parameter Menu). The same parameter is in menu Parameters -> Group 3.15 -> P3.15.5. By default, the interlock function is disabled. Select <i>Enabled</i>, if the interlock signal is connected to the digital input DI5 of the drive. The interlock signal is the digital input signal that tells if this pump is available in the Multi-pump system. Select <i>Not Used</i>, if the interlock signal is not connected to the digital input DI5 of the drive. The system sees that all the pumps in the Multi-pump system are available.
9	<p>Examine the source of the PID setpoint signal.</p> <ul style="list-style-type: none"> By default, the PID setpoint value comes from parameter P1.35.9 Keypad Setpoint 1. If it is necessary, you can change the source of the PID setpoint signal with parameter P1.35.8. You can select the analogue input or Fieldbus Process Data In 1-8, for example.

The basic settings of the Multi-pump system are completed. You can use the check list also when you configure the next drives in the system.

10.16.2 SYSTEM CONFIGURATION

The Multi-pump function has 2 different configurations. The configuration is specified by the quantity of drives in the system.

SINGLE DRIVE CONFIGURATION

The Single drive mode controls a system of 1 variable speed pump and the maximum of 7 auxiliary pumps. The internal PID controller of the drive controls the speed of 1 pump and gives control signals with relay outputs to start or stop the auxiliary pumps. External contactors are necessary for the switch of the auxiliary pumps to the mains.

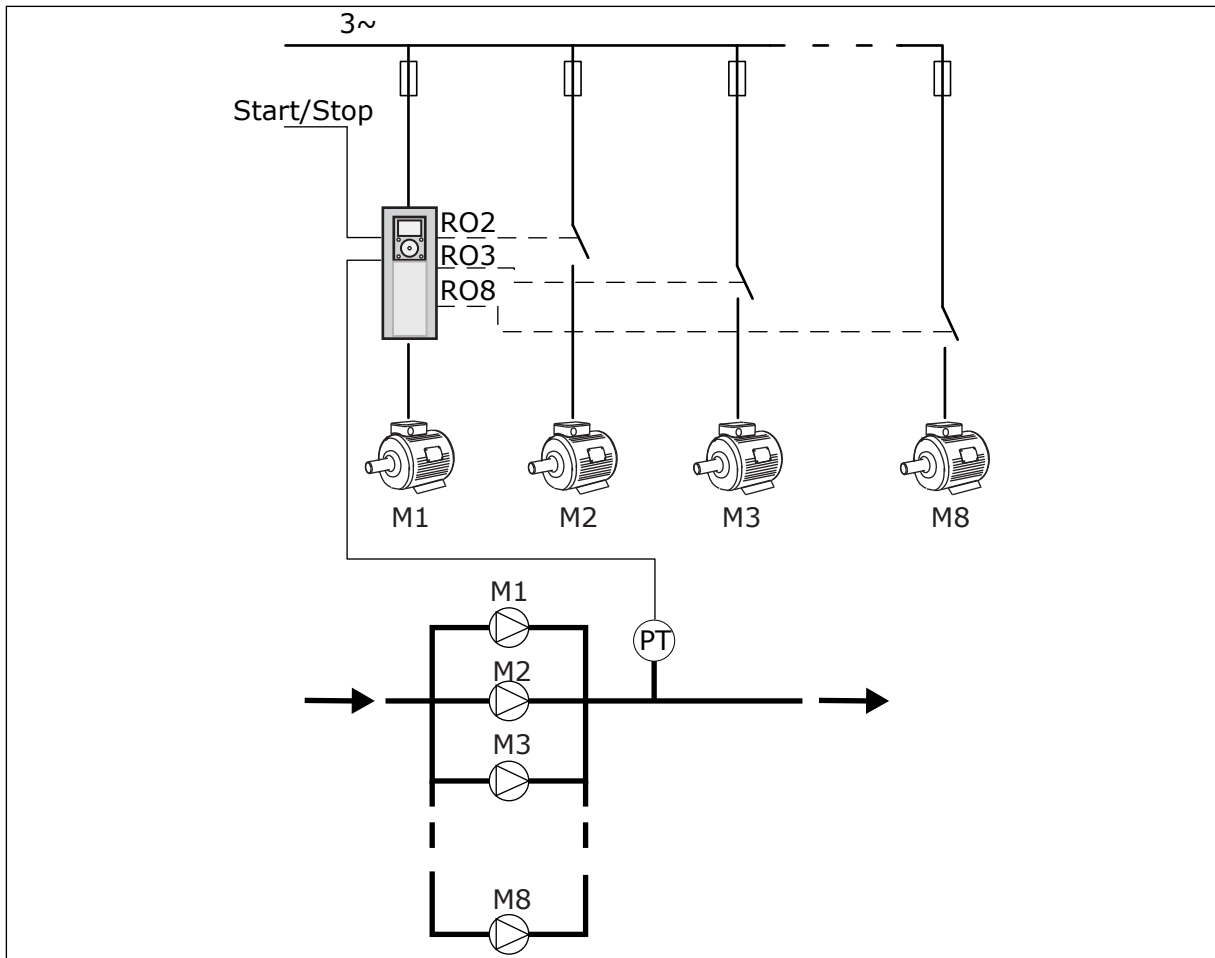

Fig. 90: Single drive configuration (PT = pressure sensor)

MULTIDRIVE CONFIGURATION

The Multidrive modes (Multimaster and Multifollower) control a system that has the maximum 8 variable speed pumps. Each pump is controlled by a drive. The internal PID controller of the drive controls all pumps. The drives use a communication bus (Modbus RTU) for communication.

The figure below shows the Multidrive configuration principle. See also the general electric diagram of a Multi-pump system in Fig. 18 *Electric wiring diagramme of the Multi-pump (multidrive) system, example 1A*.

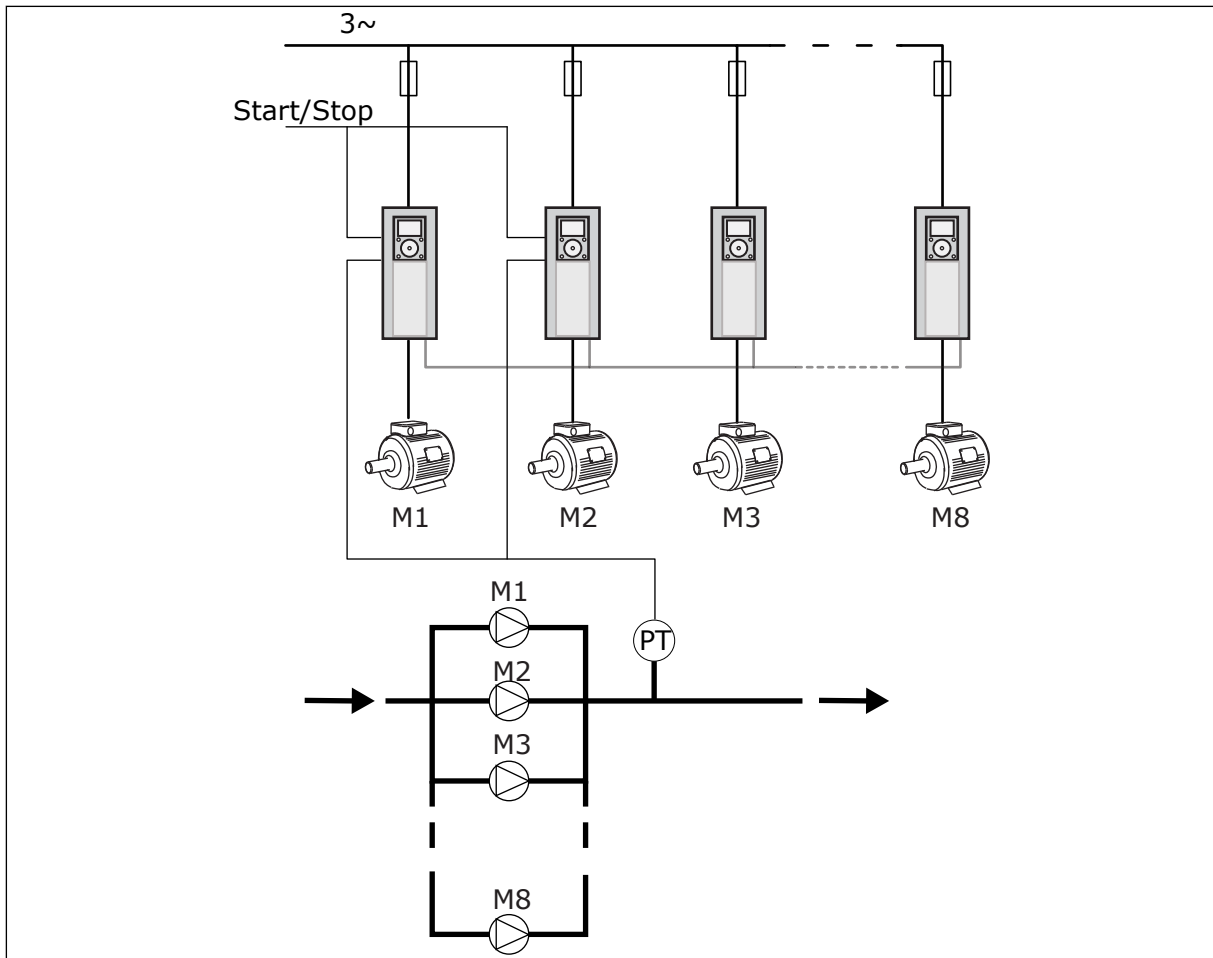

Fig. 91: Multidrive configuration (PT = pressure sensor)

P3.15.1 MULTI-PUMP MODE (ID 1785)

Use this parameter to select the configuration and the control mode of the Multi-pump system. The Multi-pump function lets you control a maximum of 8 motors (that is, pumps, fans, compressors) with the PID control.

0 = SINGLE DRIVE

The Single drive mode controls a system that has 1 pump that can change speed and the maximum of 7 auxiliary pumps. The internal PID controller of the drive controls the speed of 1 pump and gives control signals with relay outputs to start or stop the auxiliary pumps. External contactors are necessary for the switch of the auxiliary pumps to the mains. 1 of the pumps is connected to the drive and controls the system. When the pump in control sees that it is necessary to have more capacity (operates at the maximum frequency), the drive gives the control signal with the relay output to start the next auxiliary pump. When the auxiliary pump starts, the pump in control continues to control and starts from the minimum frequency.

When the pump that controls the system sees that there is too much capacity (operates at the minimum frequency), the pump makes the started auxiliary pump to stop. If no auxiliary pumps operate when the pump in control sees the overcapacity, the pump goes to the Sleep mode (if the Sleep function is enabled).

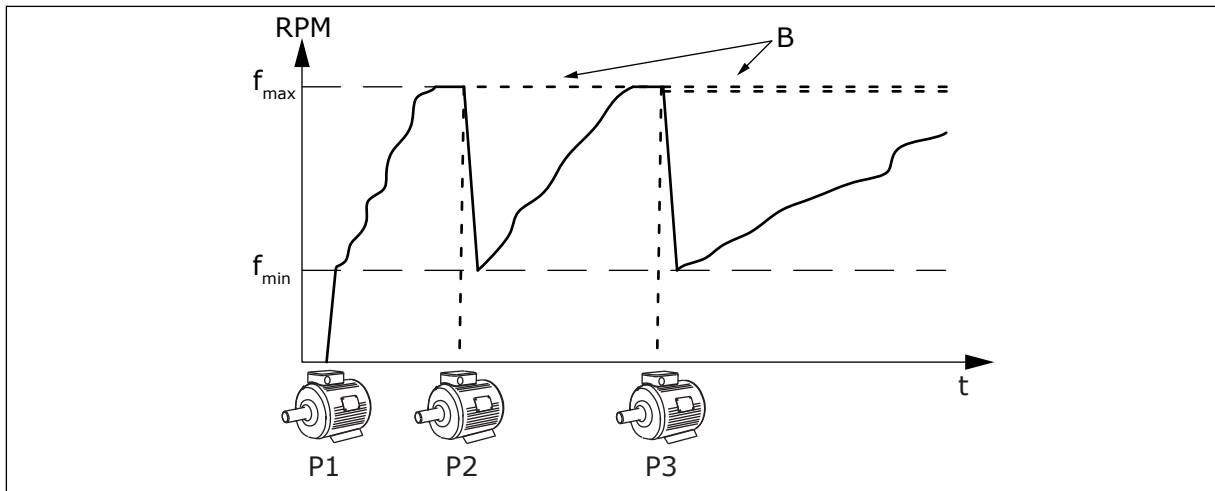

Fig. 92: Control in the Single drive mode

P1 The pump that controls the system

B The auxiliary pumps connected to the mains (direct on-line)

1 = MULTIFOLLOWER

The Multifollower mode controls a system that has the maximum 8 pumps that can change speed. Each pump is controlled by a drive. The internal PID controller of the drive controls all the pumps.

1 of the pumps always controls the system. When the pump in control sees that it is necessary to have more capacity (operates at the maximum frequency), the pump uses the communication bus to make the next pump to start. The next pump increases speed and starts to operate at the speed of the pump in control. Auxiliary pumps operate at the speed of the pump that controls the system.

When the pump that controls the system sees that there is too much capacity (operates at the minimum frequency), it makes the started pump to stop. If no auxiliary pumps operate when the pump in control sees overcapacity, the pump goes to the Sleep mode (if the Sleep function is enabled).

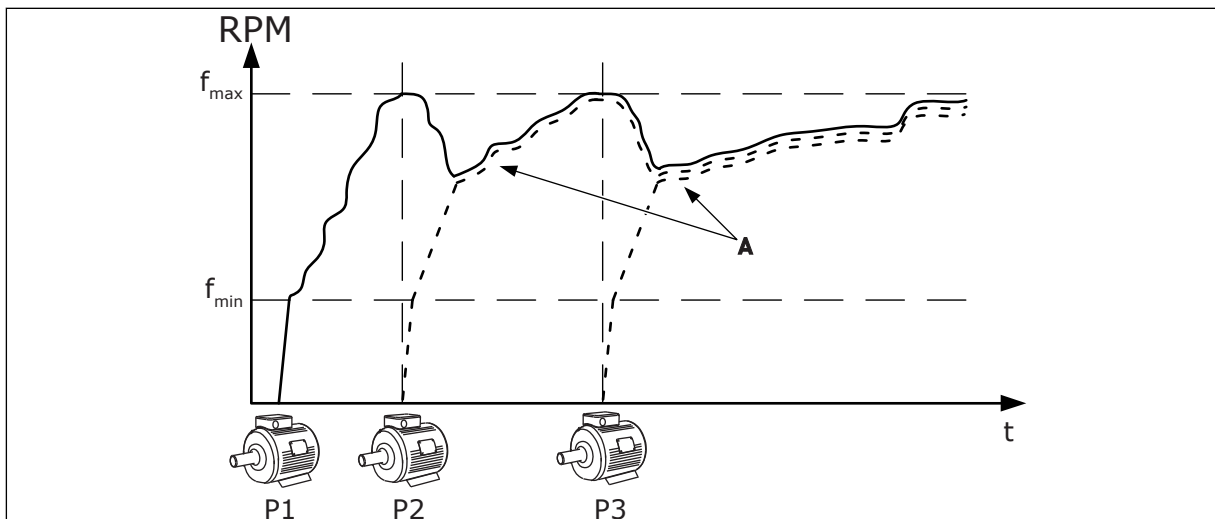

Fig. 93: Control in the Multifollower mode

P1 The pump controls the system.

P2 The pump follows the speed of P1.

P3 The pump follows the speed of P1.

A Curve A shows the auxiliary pumps that follow the speed of pump 1.

2 = MULTIMASTER

The Multimaster mode controls a system that has the maximum 8 pumps that can change speed. Each pump is controlled by a drive. The internal PID controller of the drive controls all the pumps.

1 of the pumps always controls the system. When the pump in control sees that it is necessary to have more capacity (operates at the maximum frequency), it locks to a constant production speed and makes the next pump to start and to control the system.

When the pump that controls the system sees that there is too much capacity (operates at the minimum frequency), it stops. The pump that operates at a constant production speed starts to control the system. If there are many pumps that operate at a constant production speed, the started pump starts to control the system. If no pumps operate at a constant production speed when the pump in control sees the overcapacity, the pump goes to the Sleep mode (if the Sleep function is enabled).

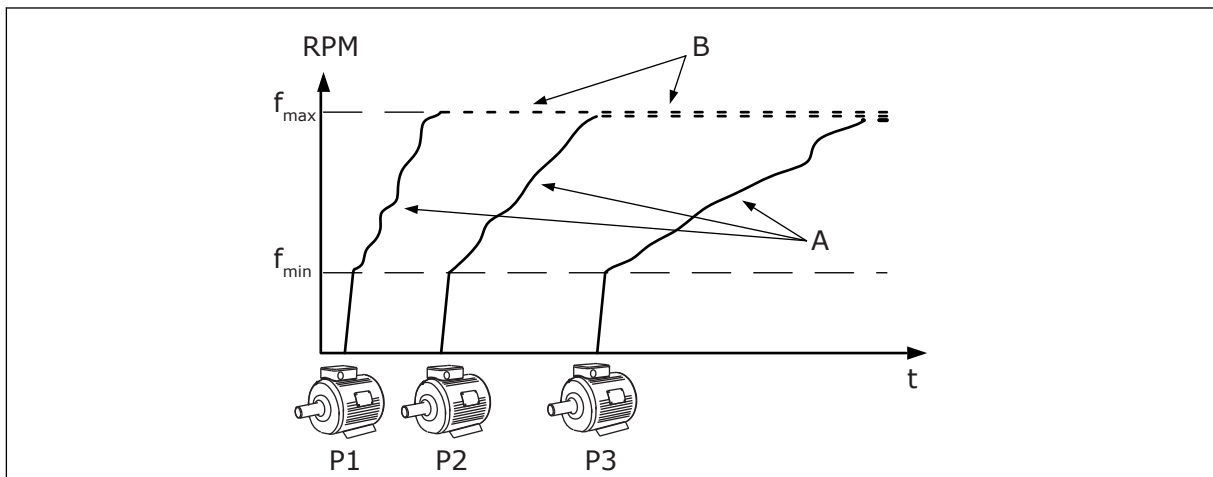

Fig. 94: Control in the Multimaster mode

A. Curves A shows the control of the pumps B. The pumps are locked to the constant production frequency

P3.15.2 NUMBER OF PUMPS (ID 1001)

Use this parameter to set the total number of motors/pumps used in the Multi-pump system. The maximum number of pumps in the Multi-pump system is 8.

Set this parameter in the installation. If you remove 1 drive to do the servicing of the pump, for example, it is not necessary to change this parameter.



NOTE!

In the Multifollower and Multimaster modes, all drives must have the same value in this parameter for the correct communication between the drives.

P3.15.3 PUMP ID NUMBER (ID 1500)

Use this parameter to set the ID number of the drive. This parameter is used only in the Multifollower and Multimaster modes.

Each drive in the Multi-pump system must have a unique sequence (ID) number, always start from 1.

Pump number 1 is always the primary master of the Multi-pump system. Drive number 1 controls the process and the PID controller. The PID feedback and the PID setpoint signals must be connected to the drive number 1.

If the drive number 1 is not available in the system, there is a power-down of the drive, for example, the next drive starts to operate as a secondary master of the Multi-pump system.

**NOTE!**

The communication between the drives is not correct, if:

- the Pump ID numbers are not in a numerical order (start from 1), or
- 2 drives have the same ID number.

P3.15.4 START AND FEEDBACK SIGNALS (ID 1782)

Use this parameter to select the signals that are connected to the drive.

0 = The start and the PID feedback signals not connected to the drive in question

1 = Only the start signals connected to the drive in question

2 = The start and the PID feedback signals connected to the drive in question

**NOTE!**

The operation mode (master or slave) in the Multi-pump system is specified by this parameter. The drives that have the start command and the PID feedback signals connected, can operate as the master drive in the Multi-pump system. If there are many drives in the Multi-pump system that have all the signals connected, the drive with the lowest Pump ID Number (P3.15.3) starts to operate as the master.

10.16.3 INTERLOCKS

The interlocks tell the Multi-pump system that a motor is not available. This can occur when the motor is removed from the system for maintenance or bypassed for manual control.

P3.15.5 PUMP INTERLOCKING (ID 1032)

Use this parameter to enable or disable the interlocks. Interlock signal tells to the Multi-pump system if the motor is available or not. Interlock signals are given with DI signals. To use the interlocks, enable the parameter P3.15.2. Select the status for each motor with a digital input (the parameters from P3.5.1.34 to P3.5.1.39). If the value of the input is CLOSED, that is, active, the Multi-pump logic connects the motor to the Multi-pump system.

10.16.4 FEEDBACK SENSOR CONNECTION IN A MULTI-PUMP SYSTEM

You get the best precision and redundancy in the Multi-pump system when you use feedback sensors for each drive.

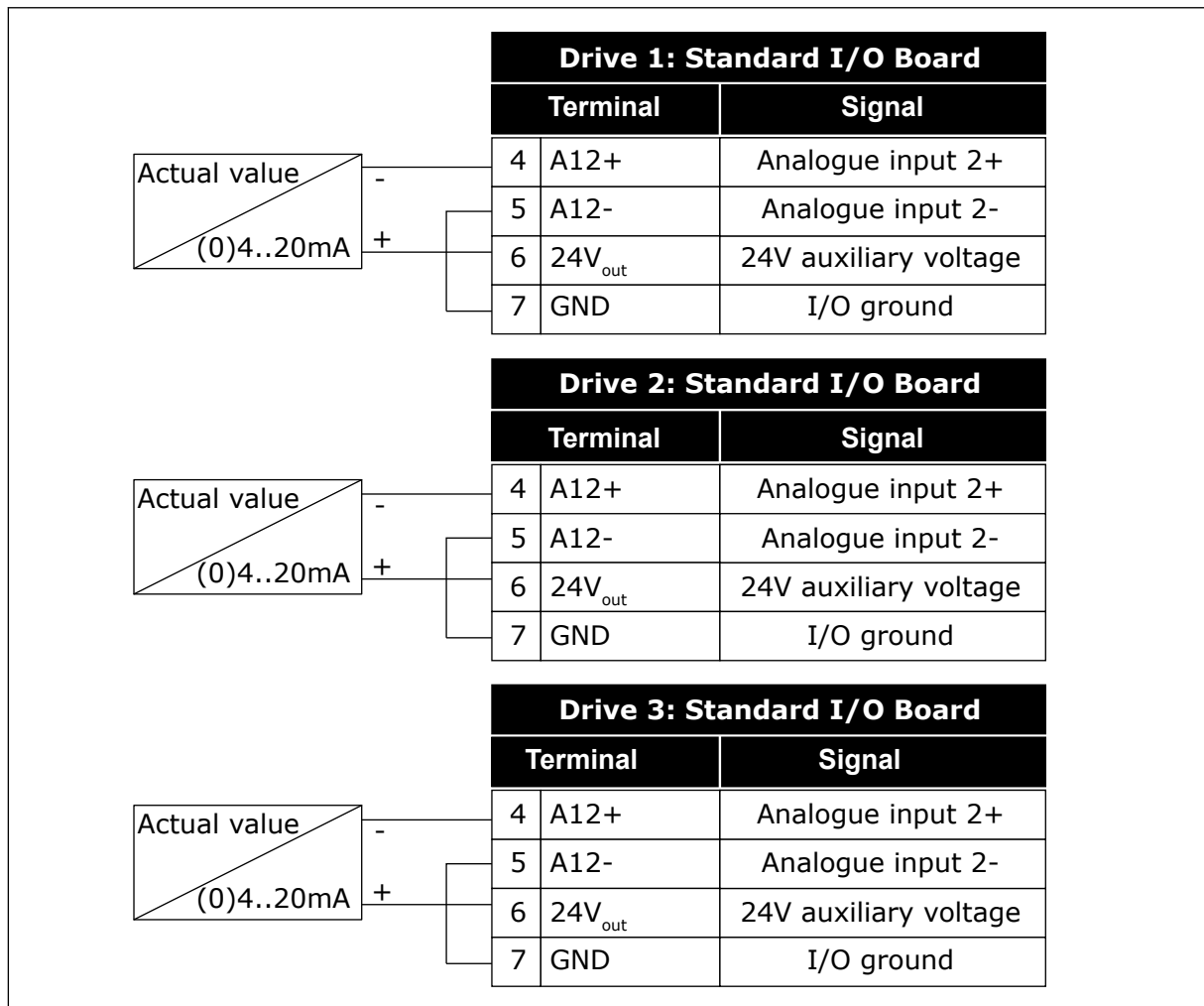

Fig. 95: Wiring of the feedback sensors for each drive

You can also use the same sensor for all the drives. The sensor (transducer) can be supplied by an external 24V power supply or from the control board the drive.

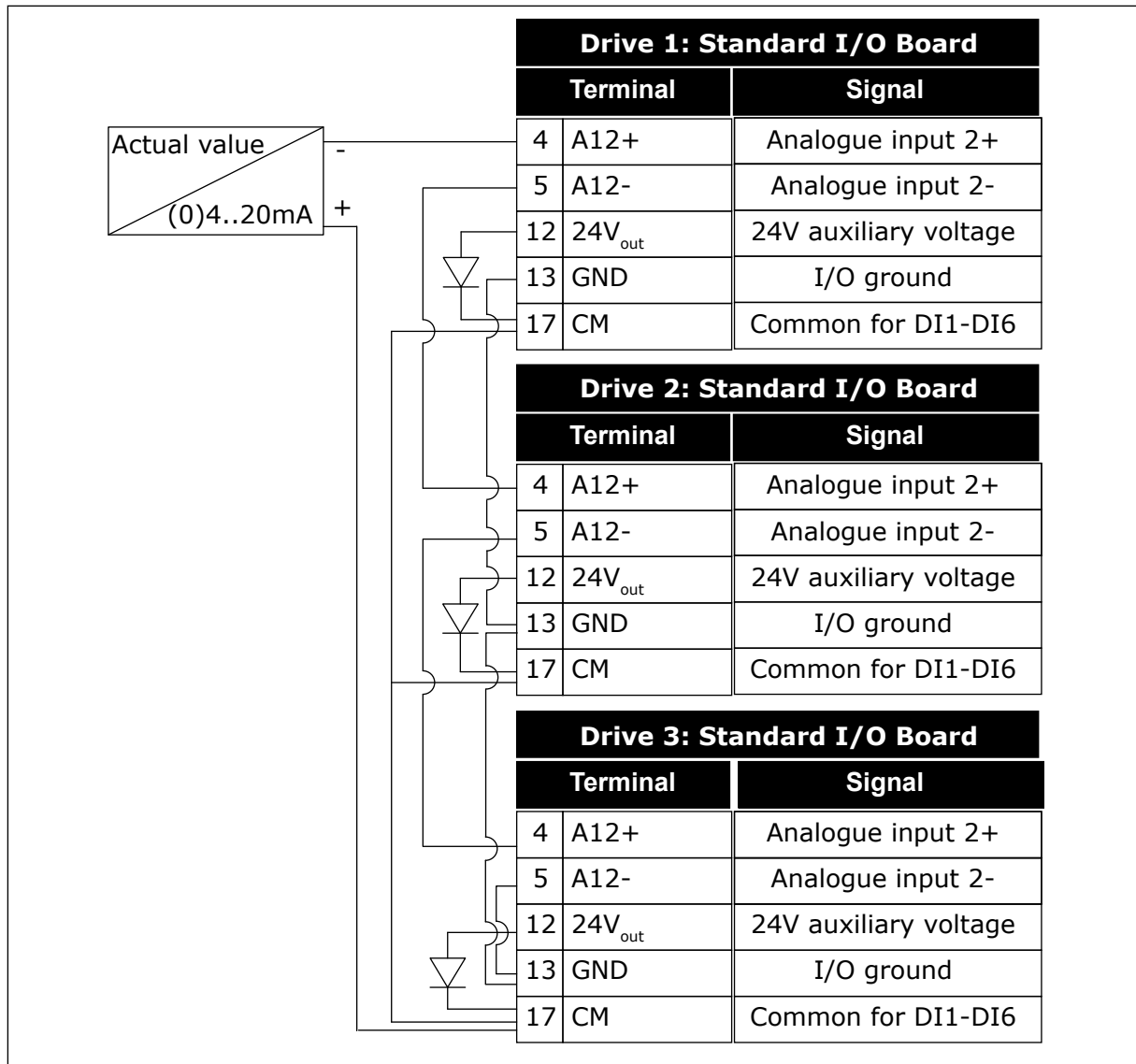

Fig. 96: Wiring of the same sensor for all drives (supplied from the I/O board of the drive)

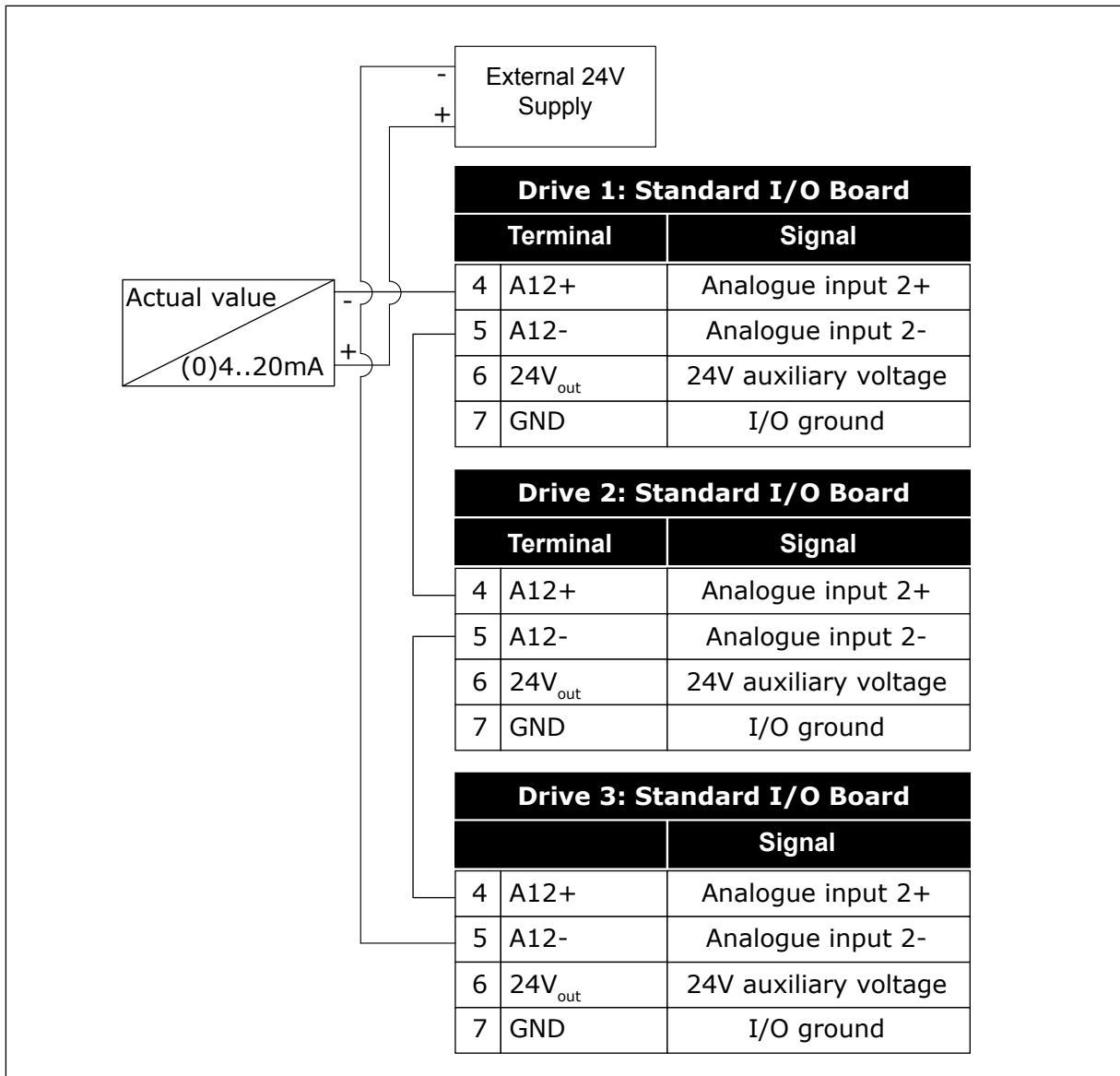

Fig. 97: Wiring of the same sensor for all drives (supplied from an external 24V)

If a sensor is supplied from the I/O board of the drive and the diodes are connected between terminals 12 and 17, the digital inputs must be isolated from the ground. Set the isolation DIP switch to *Float*.

The digital inputs are active when they are connected to *GND*, which is the default condition.

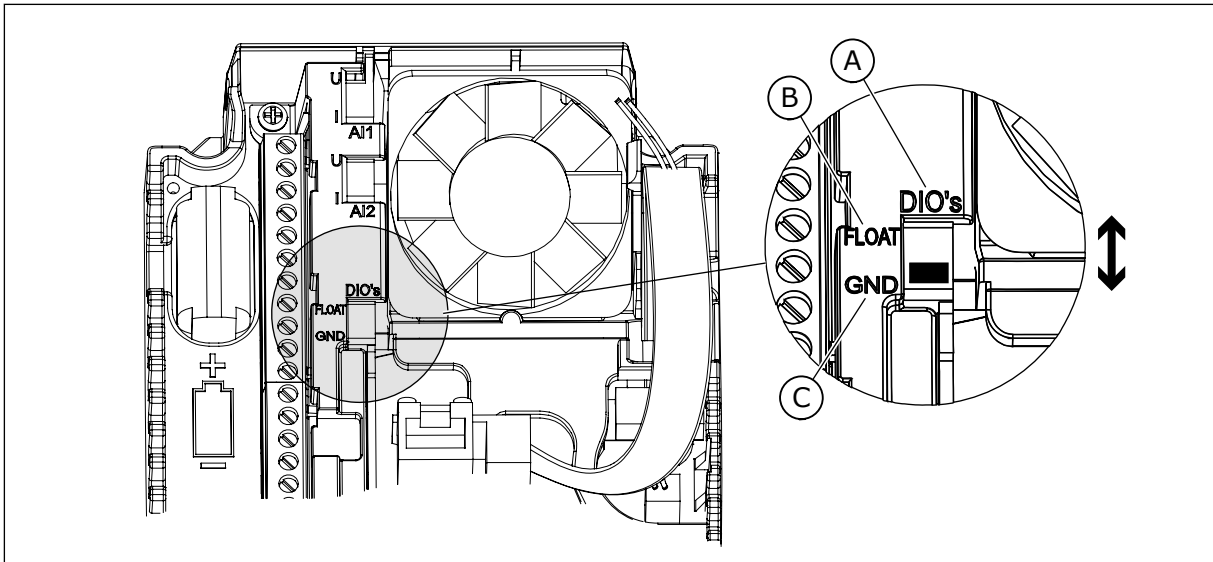

Fig. 98: Isolation DIP switch

- A. Digital inputs
- B. Float
- C. Connected to GND (default)

P3.15.6 AUTOCHANGE (ID 1027)

Use this parameter to enable or disable the rotation of the start sequence and the priority of motors. The autochange changes the sequence in which the motors start to wear the motors equally.

The monitoring values V2.10.7 Pump 1 Running Time – V2.10.14 Pump 8 Running Time count the run time of the motors. The autochange function sets the start sequence in according to the run times. The motor that has the lowest running hours starts first and the motor that has the highest running hours starts last.

Selection number	Selection name	Description
0	Disabled	In normal operation, the sequence of the motors is always 1, 2, 3, 4, 5 . The sequence can change during the operation if you add or remove interlocks. After the drive stops, the sequence always changes back.
1	Enabled (interval)	The system changes the sequence at intervals to wear the motors equally. You can adjust the intervals of the autochange with parameter P3.15.8. The timer of the autochange interval operates only when the Multi-pump system operates.
2	Enabled (weekdays)	The start sequence changes at the selected weekday and time of day. Make the selection with parameters P3.15.9 and P3.15.10. To use this mode, an RTC battery must be installed in the drive.

Example

After an autochange, the first motor is put last. The other motors move up 1 position.

The start sequence of the motors: 1, 2, 3, 4, 5

--> Autochange -->

The start sequence of the motors: 2, 3, 4, 5, 1

--> Autochange -->

The start sequence of the motors: 3, 4, 5, 1, 2

P3.15.7 AUTOCHANGED PUMPS (ID 1028)

Use this parameter to include the controlled motor/pump in the autochange and interlock system.

Selection number	Selection name	Description
0	Auxiliary pumps	The drive is always connected to Motor 1. The interlocks do not have an effect on Motor 1. Motor 1 is not included in the autochange logic.
1	All pumps	It is possible to connect the drive to any of the motors in the system. The interlocks have an effect on all the motors. All the motors are included in the autochange logic.

WIRING

The connections are different for the parameter values *0* and *1*.

SELECTION 0, AUXILIARY PUMPS

The drive is directly connected to Motor 1. The other motors are auxiliary motors. They are connected to the mains by contactors, and controlled by relays of the drive. The autochange or the interlock logic do not have an effect on Motor 1.

SELECTION 1, ALL PUMPS

To include the regulating motor in the autochange or in the interlock logic, obey the instructions in the figure below. 1 relay controls each motor. The contactor logic always connects the first motor to the drive, and the next motors to the mains.

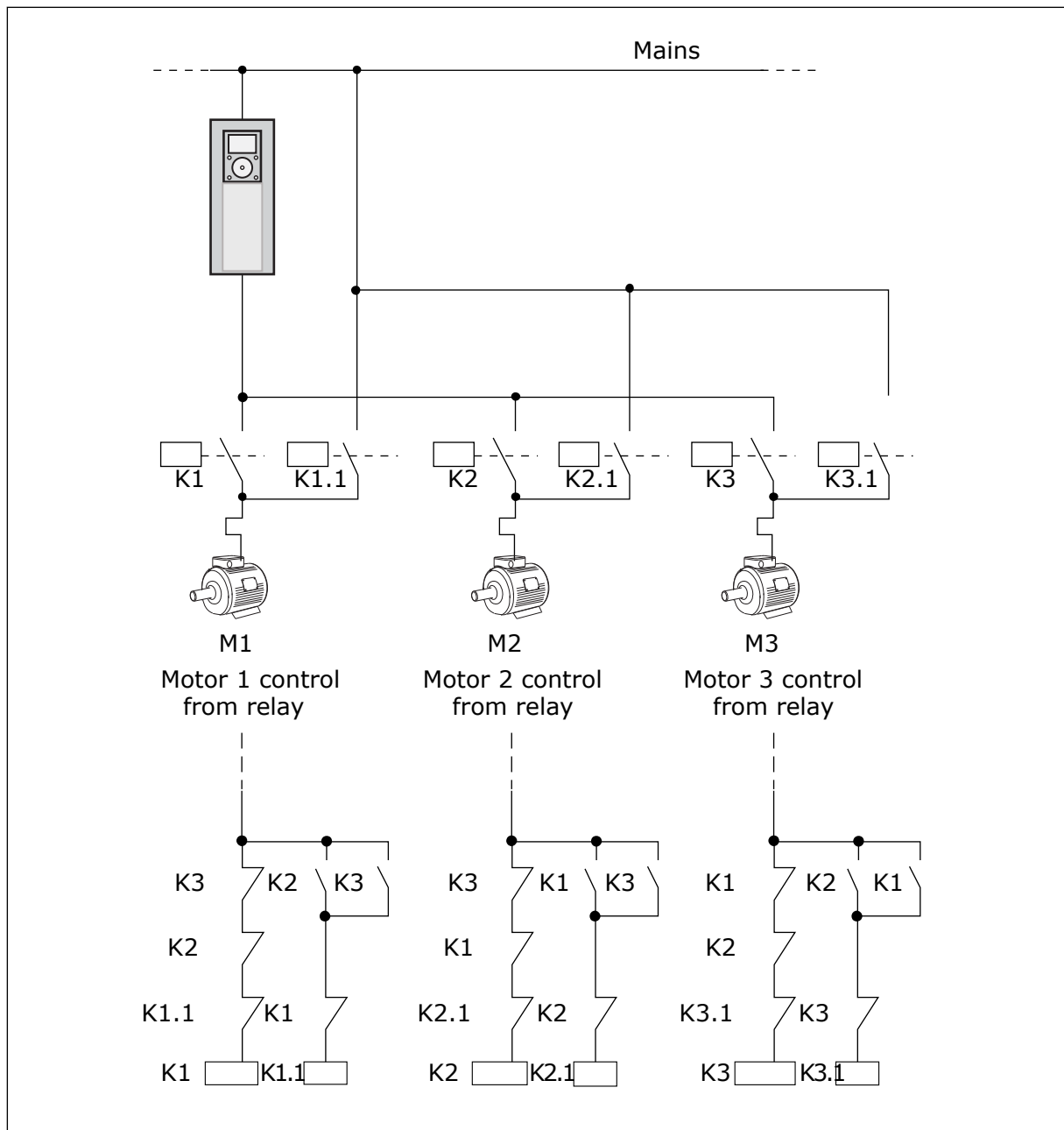

Fig. 99: Selection 1

P3.15.8 AUTOCHANGE INTERVAL (ID 1029)

Use this parameter to adjust the autochange intervals. The Autochange interval is the time after which the autochange function starts if the used capacity is below the set level. The value of this timer does not run when the Multi-pump system is stopped or in the sleep mode. To use the parameter, select *Enabled (interval)* with parameter P3.15.6 Autochange Mode.

The autochange occurs, if:

- the Multi-pump system operates (the start command is active),
- the autochange interval time goes,
- the pump that controls the system operates below the frequency specified by parameter P3.15.11 Autochange Frequency Limit,
- the number of pumps that operate is less or equal to the limit specified by parameter P3.15.12 Autochange Pump Limit.

P3.15.9 AUTOCHANGE DAYS (ID 1786)

Use this parameter to set the days of the week when the autochange function starts. The value of this parameter is applied if the autochange mode is 'Enabled (Weekdays)'.

P3.15.10 AUTOCHANGE TIME OF DAY (ID 1787)

Use this parameter to set the time of the day when the autochange function starts. The value of this parameter is applied if the autochange mode is *Enabled (Weekdays)*.

To use the parameters, select *Enabled (Weekdays)* with parameter P3.15.6 Autochange.

The autochange occurs, if:

- the Multi-pump system operates (the start command is active),
- it is the autochange weekday and the time of day,
- the pump that controls the system operates below the frequency specified by parameter P3.15.11 Autochange Frequency Limit,
- the number of pumps that operate is less or equal to the limit specified by parameter P3.15.12 Autochange Pump Limit.

P3.15.11 AUTOCHANGE FREQUENCY LIMIT (ID 1031)

Use this parameter to set the autochange frequency limit.

The autochange frequency limit is the limit below which the output frequency of the regulating drive must stay for the autochange to start.

P3.15.12 AUTOCHANGE PUMP LIMIT (ID 1030)

Use this parameter to set the amount of pumps used in the Multi-pump function.

The Autochange Pump Limit is the limit below which the number of the running motors must stay for the autochange to start.

If the number of pumps that operate in the Multi-pump system is less or equal to the limit specified by parameter P3.15.12 and the pump that controls the system operates below the frequency specified by parameter P3.15.11, the autochange can occur.



NOTE!

These parameters are used in the Single drive mode, because the autochange can restart the system (depending on the quantity of motors that operate).

In the Multifollower and Multimaster modes, set these parameters to the maximum values to make it possible for the autochange to occur immediately at the autochange time. In the Multifollower and Multimaster modes, the quantity of pumps that operate does not have an effect on the autochange.

P3.15.13 BANDWIDTH (ID 1097)

Use this parameter to set the bandwidth area around the PID setpoint for starting and stopping of the auxiliary motors.

When the PID feedback value stays in the bandwidth area, the auxiliary motors do not start or stop. The value of this parameter is given as a percentage of the setpoint.

P3.15.14 BANDWIDTH DELAY (ID 1098)

Use this parameter to set the duration before the auxiliary motors start or stop.

When the PID feedback is not in the bandwidth area, the time that is set with this parameter must go before the auxiliary motors start or stop. The number of pumps that operate increases or decreases, if the PID controller cannot keep the process value (feedback) in the specified bandwidth around the setpoint.

The bandwidth area is specified as a percentage of the PID setpoint. When the PID feedback value stays in the bandwidth area, it is not necessary to increase or decrease the number of pumps that operate.

When the feedback value goes out of the bandwidth area, the quantity of time specified by parameter P3.15.14 must go before the number of pumps that operate increases or decreases. More pumps must be available.

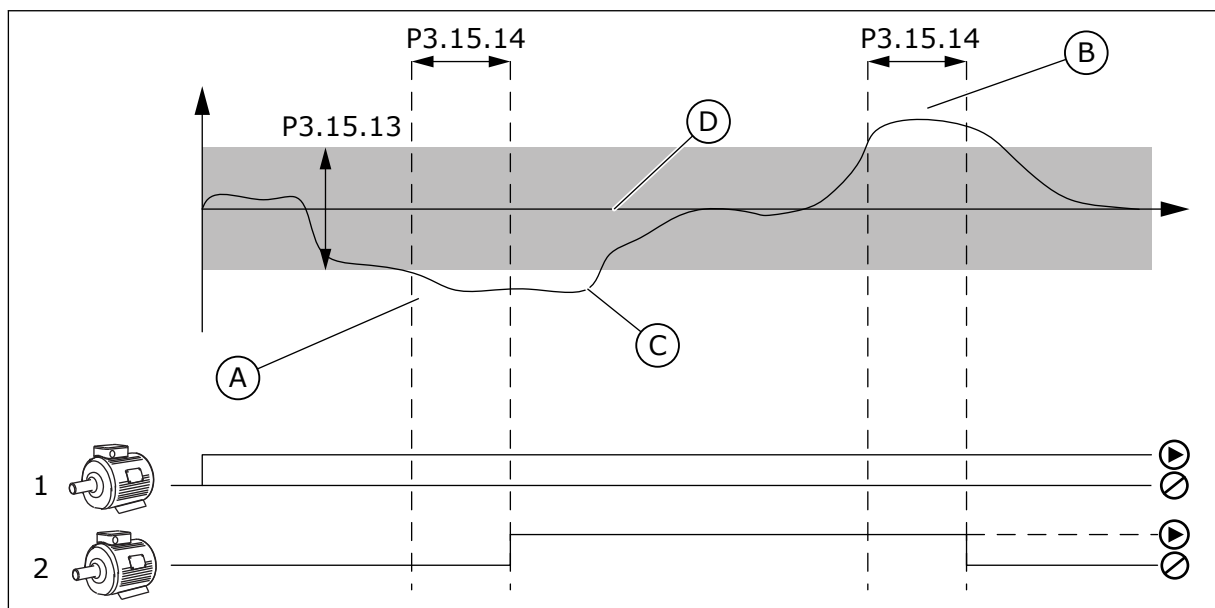

Fig. 100: The start or stop of the auxiliary pumps (P3.15.13 = Bandwidth, P3.15.14 = Bandwidth delay)

- | | |
|---|---|
| <p>A. The pump that controls the system operates at a frequency that is near the maximum (-2Hz). This increases the number of pumps that operate.</p> <p>B. The pump that controls the system operates at a frequency that is near the minimum (+2Hz). This decreases the number of pumps that operate.</p> | <p>C. The number pumps that operate increases or decreases, if the PID controller cannot keep the process value feedback in the specified bandwidth around the setpoint.</p> <p>D. The specified bandwidth around the setpoint.</p> |
|---|---|

P3.15.15 CONSTANT PRODUCTION SPEED (ID 1513)

Use this parameter to set the constant speed at which the motor locks when the next motor starts in the Multimaster system.

The value of this parameter is given as a percentage of the minimum frequency to the maximum frequency.

P3.15.16 RUNNING PUMPS LIMIT (ID 1187)

Use this parameter to set the maximum number of motors that run at the same time in the Multi-pump system.



NOTE!

If the value of parameter P3.15.2 Number of Pumps changes, the same value changes automatically to this parameter.

Example:

The Multi-pump system has 3 pumps, but only 2 pumps can operate at the same time. The third pump is installed in the system for redundancy. The number of pumps that can operate at the same time:

- Running Pump Limit = 2

P3.15.17.1 PUMP 1 INTERLOCK (ID 426)

Use this parameter to select the digital input signal that is used as interlock signal for the Multi-pump system.

When the Pump interlocking function (P3.15.5) is enabled, the drive reads the statuses of the digital inputs of the pump interlock (feedback). When the input is CLOSED, the motor is available for the Multi-pump system.

When the Pump interlocking function (P3.15.5) is disabled, the drive does not read the statuses of the digital inputs of the pump interlock (feedback). The Multi-pump system sees all pumps in the system as available.

- In the Single drive mode, the digital input signal that is selected with this parameter shows the interlock status of pump 1 in the Multi-pump system.
- In the Multifollower and Multimaster modes, the digital input signal that is selected with this parameter shows the interlock status of the pump that is connected to this drive.

P3.15.17.2 PUMP 2 INTERLOCK (ID 427)

Use this parameter to select the digital input signal that is used as interlock signal for the Multi-pump system.

P3.15.17.3 PUMP 3 INTERLOCK (ID 428)

Use this parameter to select the digital input signal that is used as interlock signal for the Multi-pump system.

P3.15.17.4 PUMP 4 INTERLOCK (ID 429)

Use this parameter to select the digital input signal that is used as interlock signal for the Multi-pump system.

P3.15.17.5 PUMP 5 INTERLOCK (ID 430)

Use this parameter to select the digital input signal that is used as interlock signal for the Multi-pump system.

P3.15.17.6 PUMP 6 INTERLOCK (ID 486)

Use this parameter to select the digital input signal that is used as interlock signal for the Multi-pump system.

P3.15.17.7 PUMP 7 INTERLOCK (ID 487)

Use this parameter to select the digital input signal that is used as interlock signal for the Multi-pump system.

P3.15.17.8 PUMP 8 INTERLOCK (ID 488)

Use this parameter to select the digital input signal that is used as interlock signal for the Multi-pump system.

**NOTE!**

These parameters are used in the Single drive mode only.

When the Pump interlocking function (P3.15.5) is enabled, the drive reads the statuses of the digital inputs of the pump interlock. When the input is CLOSED, the motor is available for the Multi-pump system.

When the Pump interlocking function (P3.15.5) is disabled, the drive does not read the statuses of the digital inputs of the pump interlock. The Multi-pump system sees all pumps in the system as available.

10.16.5 OVERPRESSURE SUPERVISION

You can use the Overpressure supervision function in a Multi-pump system. For example, when you close the primary valve of the pump system quickly, the pressure in the pipe lines increases. The pressure can increase too quickly for the PID controller. To prevent that the pipes break, the overpressure supervision stops the auxiliary motors in the Multi-pump system.

P3.15.18.1 ENABLE OVERPRESSURE SUPERVISION (ID 1698)

Use this parameter to enable the Overpressure supervision.

The overpressure supervision monitors the feedback signal of the PID controller, that is, the pressure. If the signal becomes higher than the overpressure level, it stops all the auxiliary pumps immediately. Only the regulating motor continues to operate. When the pressure decreases, the system continues to operate, and connects the auxiliary motors again one at a time.

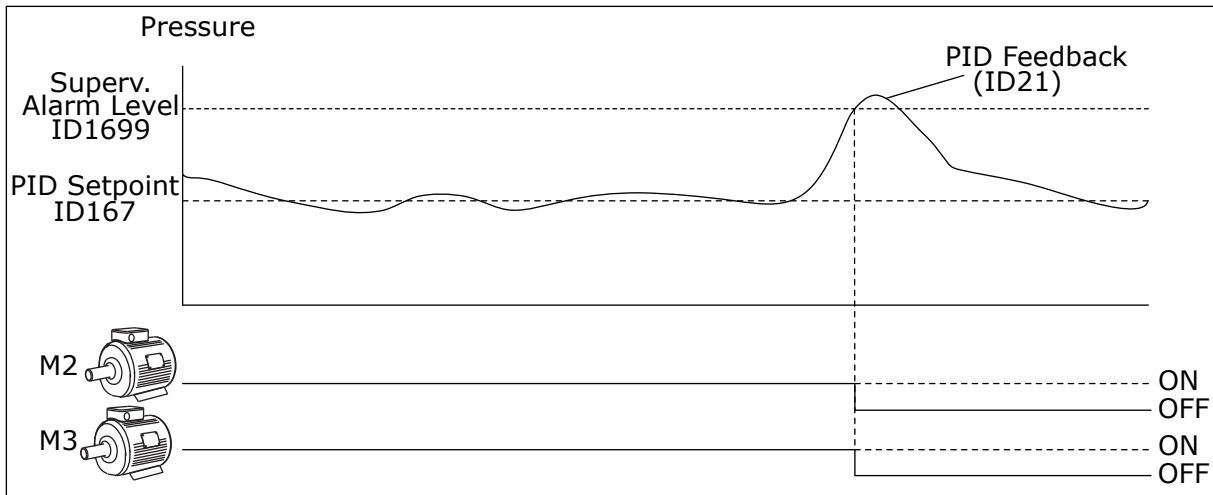

Fig. 101: The Overpressure supervision function

P3.15.18.2 SUPERVISION ALARM LEVEL (ID 1699)

Use this parameter to set the overpressure limit for the Overpressure supervision.

If the PID feedback becomes higher than the set overpressure limit, all auxiliary motors stop immediately. Only the regulating motor continues to operate.

10.16.6 PUMP RUNTIME COUNTERS

In the Multi-pump system, the time that each pump operates is monitored by a runtime counter. For example, the order that the pumps start is specified by the runtime counter values to make the wear of the pumps in the system more equal.

The pump runtime counters also tell the operator to do a maintenance on a pump (parameters P3.15.19.4 - P3.15.19.5 below).

The Pump runtime counters are in the monitoring menu, see *Table 23 Multi-pump monitoring*.

P3.15.19.1 SET RUNTIME COUNTER (ID 1673)

Use this parameter to set the value that is specified by 'Set RunTime: Value' parameter to the runtime counter of the selected pump.

P3.15.19.2 SET RUNTIME COUNTER: VALUE (ID 1087)

Use this parameter to set the value of the runtime counter of the selected pump when 'Set RunTime Counter' parameter is selected.

**NOTE!**

In the Multimaster and Multifollower modes, it is possible to reset or set the necessary value only to the counter Pump (1) Running Time. In the Multimaster and Multifollower modes, the monitoring value Pump (1) Running Time shows the hours of the pump that is connected to this drive, the ID number of the pump has no effect.

EXAMPLE

In the Multi-pump (single drive) system, pump number 4 is replaced with a new pump. The counter value of Pump 4 Running Time must be reset.

1. Select *Pump 4* with parameter P3.15.19.3.
2. Set parameter P3.15.19.2 value to *0 h*.
3. Push the button-type parameter P3.15.19.1.
4. Pump 4 Running Time is reset.

P3.15.19.3 SET RUNTIME COUNTER: PUMP SELECTION (ID 1088)

Use this parameter to select the pumps for which the runtime counter value is specified by 'Set RunTime: Value' parameter.

If the Multi-pump (single drive) mode is selected, the next selections are available:

- 0 = All Pumps
- 1 = Pump (1)
- 2 = Pump 2
- 3 = Pump 3
- 4 = Pump 4
- 5 = Pump 5
- 6 = Pump 6
- 7 = Pump 7
- 8 = Pump 8

If the Multifollower or Multimaster mode is selected, only the next selection is available:

- 1 = Pump (1)

**NOTE!**

In the Multimaster and Multifollower modes, it is possible to reset or to set a necessary value only for the the Pump (1) Running Time. In the Multimaster and Multifollower modes, the monitoring value Pump (1) Running Time shows the hours of the pump that is connected to this drive, the ID number of the pump has no effect.

EXAMPLE

In the Multi-pump (single drive) system, pump number 4 is replaced with a new pump. The counter value of Pump 4 Running Time must be reset.

1. Select *Pump 4* with parameter P3.15.19.3.
2. Set parameter P3.15.19.2 value to *0 h*.
3. Push the button-type parameter P3.15.19.1.
4. Pump 4 Running Time is reset.

P3.15.19.4 PUMP RUNTIME ALARM LIMIT (ID 1109)

Use this parameter to set the alarm limit for the runtime counter of the pump.

When the value of the pump runtime counter goes above this limit, a runtime counter alarm occurs.

P3.15.19.5 PUMP RUNTIME FAULT LIMIT (ID 1110)

Use this parameter to set the fault limit for the runtime counter of the pump.

When the value of the pump runtime counter goes above this limit, a runtime counter fault occurs.

10.16.7 ADVANCED SETTINGS

P3.15.22.1 STAGING FREQUENCY (ID 15545)

Use this parameter to adjust the output frequency level at which the auxiliary motor starts in the Multi-pump system.



NOTE!

The parameter has no effect, if its value is set above Max Frequency Reference (P3.3.1.2).

By default, an auxiliary pump starts (is staged), if the PID feedback signal goes below the specified bandwidth area and the pump that controls the system operates at the maximum frequency.

The auxiliary pump can start at a lower frequency to get better process values or to use less energy. Then, use the parameter to set the start frequency of the auxiliary pump below the maximum frequency.

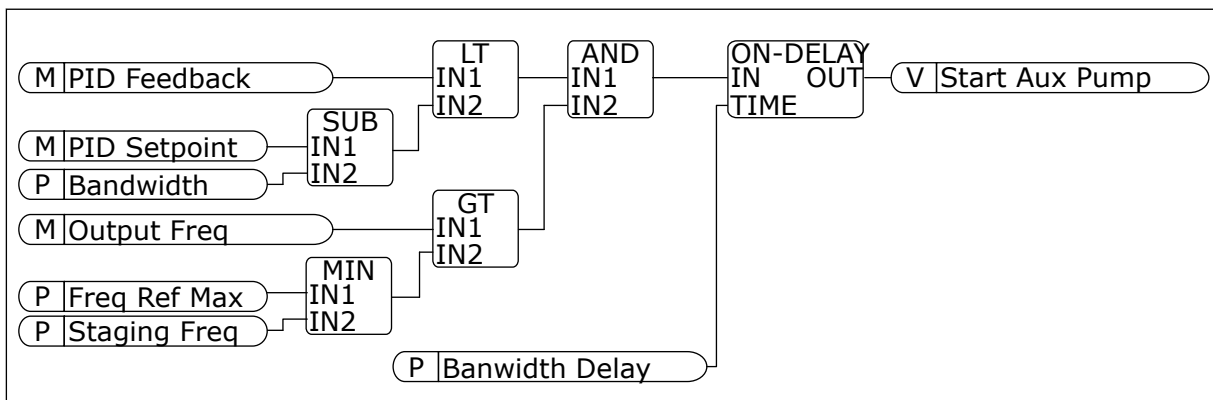

Fig. 102: Staging frequency

P3.15.22.2 DE-STAGING FREQUENCY (ID 15546)

Use this parameter to adjust the output frequency level at which the auxiliary motor stops in the Multi-pump system.



NOTE!

The parameter has no effect, if its value is set below Min Frequency Reference (P3.3.1.1).

By default, an auxiliary pump stops (is de-staged), if the PID feedback signal goes above the specified bandwidth area and the pump that controls the system operates at the minimum frequency.

The auxiliary pump can stop at a higher frequency to get better process values or to use less energy. Then, use the parameter to set the start frequency of the auxiliary pump above the minimum frequency.

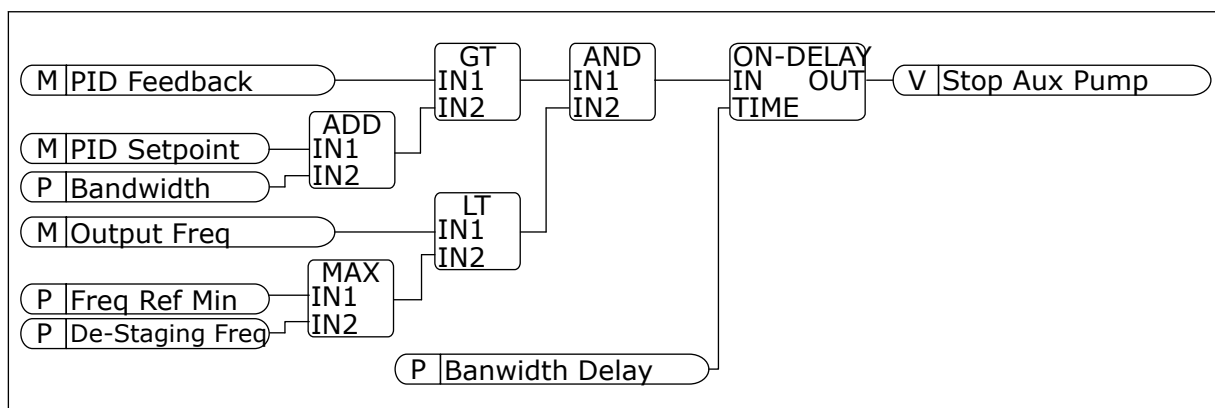

Fig. 103: De-staging frequency

10.17 MAINTENANCE COUNTERS

A maintenance counter tells you that maintenance must be done. For example, it is necessary to replace a belt or to replace the oil in a gearbox. There are 2 different modes for the maintenance counters, hours or revolutions*1000. The value of the counters increases only during the RUN status of the drive.



WARNING!

Do not do maintenance if you are not approved to do it. Only an approved electrician can do maintenance. There is a risk of injury.



NOTE!

The revolutions mode uses motor speed, which is only an estimate. The drive measures the speed every second.

When the value of a counter is more than its limit, an alarm or a fault shows. You can connect the alarm and fault signals to a digital output or a relay output.

When the maintenance is completed, reset the counter with a digital input or parameter P3.16.4 Counter 1 Reset.

P3.16.1 COUNTER 1 MODE (ID 1104)

Use this parameter to enable the maintenance counter.
A maintenance counter tells you that the maintenance must be done when the counter value goes above the set limit.

P3.16.2 COUNTER 1 ALARM LIMIT (ID 1105)

Use this parameter to set the alarm limit for the maintenance counter.
When the value of the counter goes above this limit, a maintenance alarm occurs.

P3.16.3 COUNTER 1 FAULT LIMIT (ID 1106)

Use this parameter to set the fault limit for the maintenance counter.
When the value of the counter goes above this limit, a maintenance fault occurs.

P3.16.4 COUNTER 1 RESET (ID 1107)

Use this parameter to reset the maintenance counter.

P3.16.5 COUNTER 1 DI RESET (ID 490)

Use this parameter to select the digital input that resets the value of the Maintenance Counter.

10.18 FIRE MODE

When Fire mode is active, the drive resets all faults that occur and continues to operate at the same speed until it is not possible. The drive ignores all commands from the keypad, fieldbuses, and the PC tool. It only obeys the signals Fire Mode Activation, Fire Mode Reverse, Run Enable, Run Interlock 1, and Run Interlock 2 from I/O.

The Fire mode function has 2 modes, the Test mode and the Enabled mode. To make a selection of a mode, write a password in parameter P3.17.1 (Fire Mode Password). In the Test mode, the drive does not automatically reset the faults, and the drive stops when a fault occurs.

It is also possible to configure Fire mode with the Fire mode wizard, which you can activate in the Quick Setup menu with parameter B1.1.4.

When you activate the Fire mode function, an alarm shows on the display.

**CAUTION!**

The warranty is void if the Fire mode function is activated! You can use Test mode to test the Fire mode function and the warranty stays valid.

P3.17.1 FIRE MODE PASSWORD (ID 1599)

Use this parameter to enable the Fire Mode function.

**NOTE!**

All other Fire Mode parameters will be locked when the Fire Mode is enabled and correct password is set in this parameter.

Selection number	Selection name	Description
1002	Enabled mode	The drive resets all the faults and continues to operate at the same speed until it is not possible
1234	Test mode	The drive does not automatically reset the faults, and the drive stops when a fault occurs.

P3.17.2 FIRE MODE FREQUENCY SOURCE (ID 1617)

Use this parameter to select the frequency reference source when the Fire mode is active. This parameter enables the selection of, for example, the AI1 or the PID controller as the reference source when you operate the Fire mode.

P3.17.3 FIRE MODE FREQUENCY (ID 1598)

Use this parameter to set the frequency that is used when Fire mode is active. The drive uses this frequency when the value of parameter P3.17.2 Fire Mode Frequency Source is *Fire Mode Frequency*.

P3.17.4 FIRE MODE ACTIVATION ON OPEN (ID 1596)

Use this parameter to select the digital input signal that activates the Fire Mode function. If this digital input signal is activated, an alarm shows on the display, and the warranty becomes void. The type of this digital input signal is NC (normally closed).

It is possible to try the Fire mode with the password that activates the Test mode. Then the warranty stays valid.

**NOTE!**

If Fire mode is enabled, and you give the correct password to the parameter Fire Mode Password, all the Fire mode parameters become locked. To change the Fire mode parameters, change the value of P3.17.1 Fire Mode Password to 0 first.

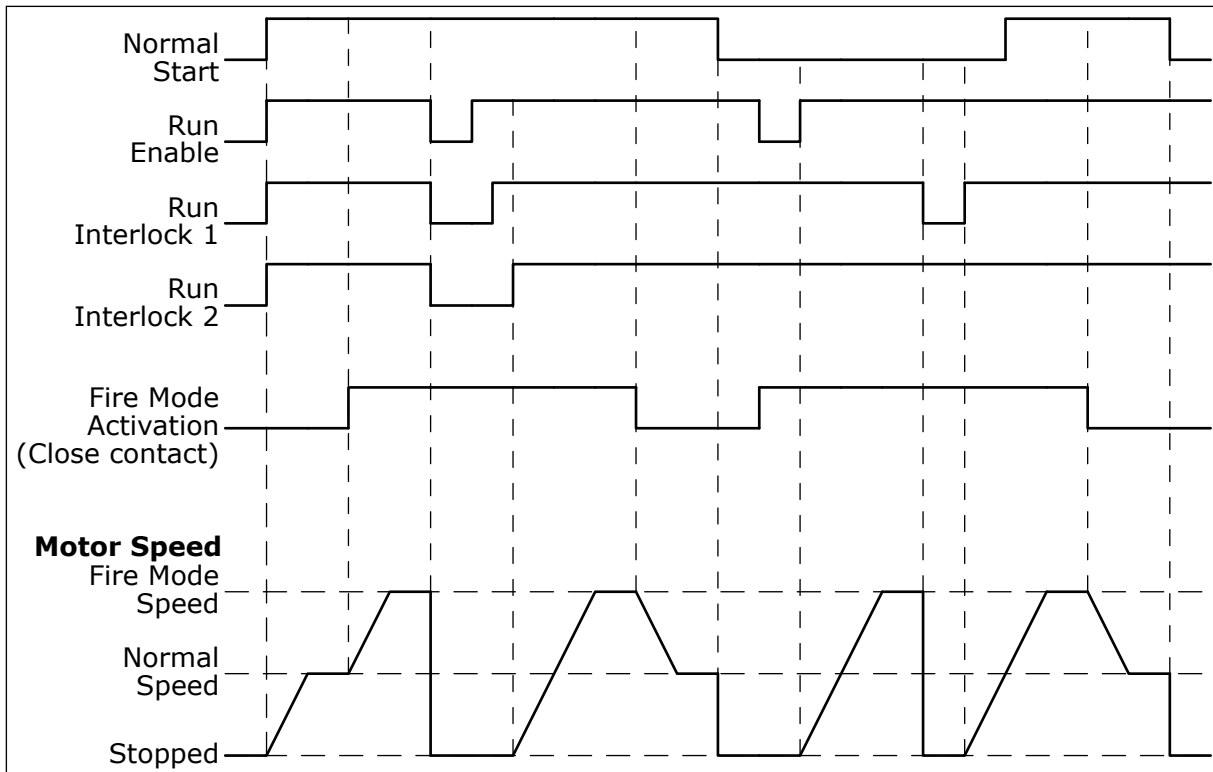

Fig. 104: The Fire mode function

P3.17.5 FIRE MODE ACTIVATION ON CLOSE (ID 1619)

Use this parameter to select the digital input signal that activates the Fire Mode function. The type of this digital input signal is NO (normally open). See the description for P3.17.4 Fire Mode Activation on Open.

P3.17.6 FIRE MODE REVERSE (ID 1618)

Use this parameter to select the digital input signal that gives a command for reverse rotation direction during the Fire Mode. The parameter does not have an effect in normal operation.

If it is necessary for the motor to operate always FORWARD or always REVERSE in Fire Mode, make a selection of the correct digital input.

DigIn Slot0.1 = always FORWARD

DigIn Slot0.2 = always REVERSE

V3.17.7 FIRE MODE STATUS (ID 1597)

This monitoring value shows the status of the Fire mode function.

V3.17.8 FIRE MODE COUNTER (ID 1679)

This monitoring value shows the number of the fire mode activations.

**NOTE!**

You can not reset the counter.

P3.17.9 FIRE MODE RUN INDICATION CURRENT (ID 15580)

Use this parameter to set the current limit for the run indication signal of the relay output.

This parameter only has effect if the value "Run indication" is selected for a relay output and the Fire mode is active. The "Run indication" relay output function tells quickly if current is supplied to the motor during a fire.

The value of this parameter is the percentage counted from the motor nominal current. If there is a fire and the current that is supplied to the motor is more than the nominal current times the value of this parameter, the relay output closes.

For example, if parameter Motor Nominal Current has the value 5 A, and you set 20% as the default value of this parameter, the relay output closes and Fire Mode activates when the output current goes to 1 A.

**NOTE!**

This parameter does not have an effect if the Fire mode is not active. In normal operation, if you select "Run indication" for a relay output, the result is the same as when "Run" is selected for the relay output.

10.19 MOTOR PREHEAT FUNCTION***P3.18.1 MOTOR PREHEAT FUNCTION (ID 1225)***

Use this parameter to enable or disable the Motor Preheat function.

The Motor preheat function keeps the drive and the motor warm during the STOP status. In the motor preheat, the system gives the motor a DC current. The motor preheat prevents for example condensation.

Selection number	Selection name	Description
0	Not used	The Motor preheat function is disabled.
1	Always in Stop state	The Motor preheat function is activated always when the drive is in the Stop state.
2	Controlled by digital input	The Motor preheat function is activated by a digital input signal, when the drive is in the Stop state. You can make the selection of the digital input for the activation with parameter P3.5.1.18.
3	Temperature limit (heatsink)	The Motor preheat function is activated if the drive is in the Stop state, and the temperature of the heatsink of the drive goes below the temperature limit that was set with parameter P3.18.2.
4	Temperature limit (measured motor temperature)	The Motor preheat function is activated if the drive is in the Stop state, and the measured motor temperature goes below the temperature limit that was set with parameter P3.18.2. You can set the measurement signal of the motor temperature with parameter P3.18.5. NOTE! To use this operation mode, you must have an option board for temperature measurement (for example OPT-BH).

P3.18.2 PREHEAT TEMPERATURE LIMIT (ID 1226)

Use this parameter to set the temperature limit of the Motor Preheat function. The motor preheat becomes active when the heatsink temperature or the measured motor temperature goes below this level, and when P3.18.1 is set to 3 or 4.

P3.18.3 MOTOR PREHEAT CURRENT (ID 1227)

Use this parameter to set the DC current of the Motor Preheat function. The DC current for the pre-heating of the motor and the drive in stop state. Activated as in P3.18.1.

P3.18.4 MOTOR PREHEAT ON (ID 1044)

Use this parameter to select the digital input signal that activates Motor Preheat function. This parameter is used when P3.18.1 is set to 2. When the value for P3.18.1 is 2, you can also connect time channels to this parameter.

10.20 DRIVE CUSTOMIZER

P3.19.1 OPERATION MODE (ID 15001)

Use this parameter to select the operation mode of the Drive customizer.

Selection number	Selection name	Description
0	Execute Program	The Drive customizer is running. Configuration is not allowed for the Drive customizer.
1	Programming	The Drive customizer is not running. Configuration is allowed for the Drive customizer.

10.21 PUMP CONTROL

10.21.1 AUTO-CLEANING

Use the Auto-cleaning function to remove dirt or other material from the pump impeller. You can also use the function to clear a blocked pipe or valve. You can use the auto-cleaning, for example, in wastewater systems to keep the performance of the pump satisfactory.

P3.21.1.1 CLEANING FUNCTION (ID 1714)

Use this parameter to enable the Auto-cleaning function.

Selection number	Selection name	Description
0	Disabled	
1	Enabled (DIN)	The cleaning sequence is started with a digital input signal. A rising edge of the digital input signal (P3.21.1.2) starts the cleaning sequence, if the start command of the drive is active. The cleaning sequence can also be activated, if the drive is in the Sleep mode (PID sleep).
2	Enabled (Current)	The cleaning sequence starts when the motor current goes above the current limit (P3.21.1.3) for a longer time than specified by P3.21.1.4.
3	Enabled (Real Time)	The cleaning sequence agrees with the internal Real Time Clock of the drive.



NOTE!

A battery must be installed in the Real Time Clock.

The cleaning sequence starts on the selected weekdays (P3.21.1.5) at the specified time of the day (P3.21.1.6), if the start command of the drive is active. The cleaning sequence can also be activated, if the drive is in the Sleep mode (PID sleep).

To stop the cleaning sequence, deactivate the start command of the drive. When 0 is selected, the cleaning function is not used.

P3.21.1.2 CLEANING ACTIVATION (ID 1715)

Use this parameter to select the digital input signal that starts the Auto-cleaning sequence. The auto-cleaning stops if the activation signal is removed before the sequence is complete.

**NOTE!**

If the input is activated, the drive starts.

P3.21.1.3 CLEANING CURRENT LIMIT (ID 1712)

Use this parameter to set the current limit at which the Auto-cleaning starts. If the current of the motor stays above this limit for longer than the set time, an auto-cleaning sequence starts.

P3.21.1.4 CLEANING CURRENT DELAY (ID 1713)

Use this parameter to set the time that the motor current must stay above the limit before the auto-cleaning starts.

Parameters P3.21.1.3 and P3.21.1.4 are used only when P3.21.1.1 = 2.

The cleaning sequence starts when the motor current goes above the current limit (P3.21.1.3) for longer than specified with P3.21.1.4. The current limit is specified as a percentage of the motor nominal current.

P3.21.1.5 CLEANING WEEKDAYS (ID 1723)

Use this parameter to set the days of the week when the Auto-cleaning is executed. This parameter is used only when P3.21.1.1 = 3.

P3.21.1.6 CLEANING TIME OF DAY (ID 1700)

Use this parameter to set the time of the day when the Auto-cleaning is executed. This parameter is used only when P3.21.1.1 = 3.

**NOTE!**

A battery must be installed in the Real Time Clock.

P3.21.1.7 CLEANING CYCLES (ID 1716)

Use this parameter to set the number of forward or reverse cleaning cycles.

P3.21.1.8 CLEAN FORWARD FREQUENCY (ID 1717)

Use this parameter to set the frequency reference of the drive for the forward direction in the Auto-cleaning cycle.

You can set the frequency and time of the cleaning cycle with the parameters P3.21.1.4, P3.21.1.5, P3.21.1.6 and P3.21.1.7.

P3.21.1.9 CLEAN FORWARD TIME (ID 1718)

Use this parameter to set the operation time for the forward direction frequency in the Auto-cleaning cycle.

See parameter P3.21.1.8 Clean Forward Frequency.

P3.21.1.10 CLEAN REVERSE FREQUENCY (ID 1719)

Use this parameter to set the frequency reference of the drive for the reverse direction in the Auto-cleaning cycle.

See parameter P3.21.1.8 Clean Forward Frequency.

P3.21.1.11 CLEAN REVERSE TIME (ID 1720)

Use this parameter to set the operation time for the reverse direction frequency in the Auto-cleaning cycle.

See parameter P3.21.1.8 Clean Forward Frequency.

P3.21.1.12 CLEANING ACCELERATION TIME (ID 1721)

Use this parameter to set the motor acceleration time when the Auto-cleaning is active. You can set acceleration and deceleration ramps for the Auto-cleaning function with parameters P3.21.1.12 and P3.21.1.13.

P3.21.1.13 CLEANING DECELERATION TIME (ID 1722)

Use this parameter to set the motor deceleration time when the Auto-cleaning is active. You can set acceleration and deceleration ramps for the Auto-cleaning function with parameters P3.21.1.12 and P3.21.1.13.

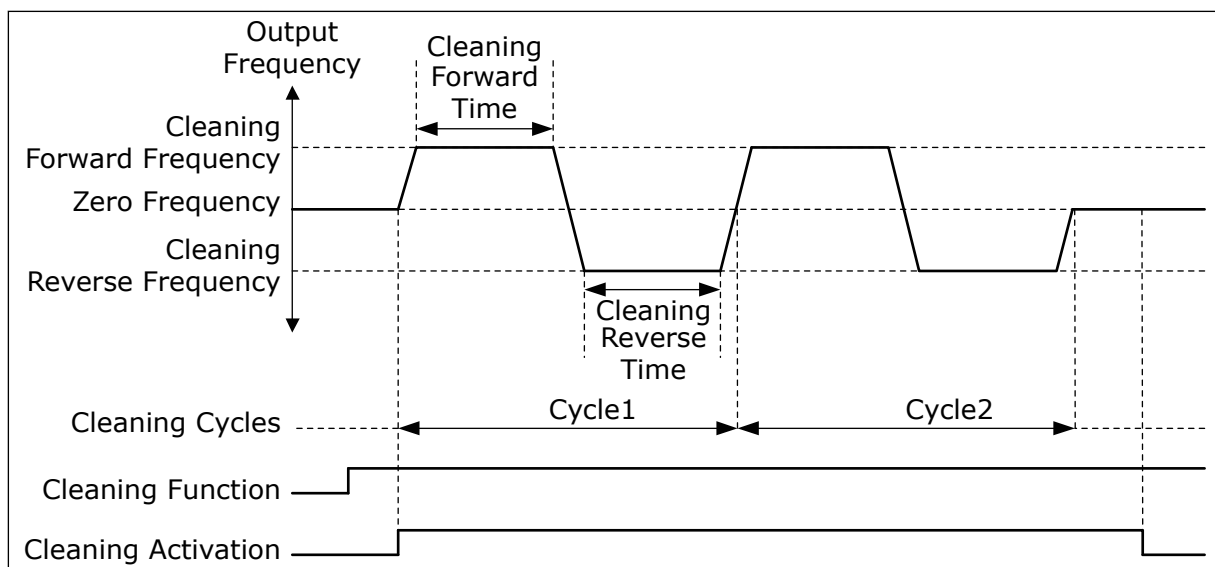

Fig. 105: The Auto-cleaning function

10.21.2 JOCKEY PUMP**P3.21.2.1 JOCKEY FUNCTION (ID 1674)**

Use this parameter to control the Jockey pump function.

A Jockey pump is a smaller pump that keeps the pressure in the pipeline, when the main pump is in the sleep mode. This can occur, for example, in the night.

The Jockey pump function controls a jockey pump with a digital output signal. You can use a jockey pump if a PID controller is used to control the main pump. The function has 3 operation modes.

Selection number	Selection name	Description
0	Not used	
1	PID sleep	The jockey pump starts when the PID Sleep of the main pump activates. The jockey pump stops when the main pump wakes up from the sleep mode.
2	PID sleep (level)	The jockey pump starts when the PID Sleep activates, and the PID feedback signal is less than the level set by parameter P3.21.2.2. The jockey pump stops when the PID feedback signal is more than the level set in parameter P3.21.2.3 or the main pump wakes up from the sleep mode.

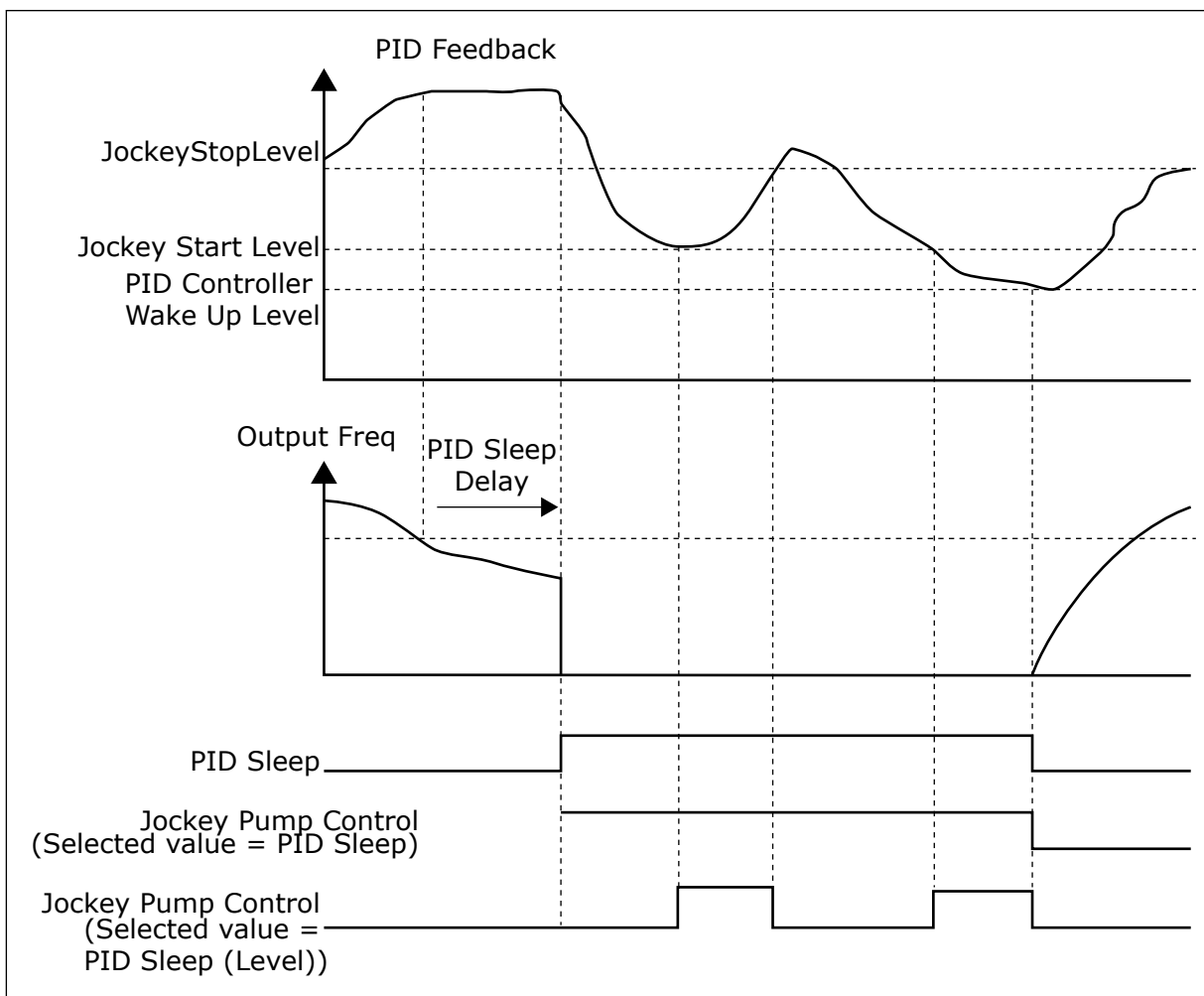

Fig. 106: The Jockey pump function

P3.21.2.2 JOCKEY START LEVEL (ID 1675)

Use this parameter to set the level of the PID feedback signal at which the jockey pump starts when the main pump is in the sleep state.

The jockey pump starts when PID Sleep is active and the PID feedback signal goes below the level set in this parameter.

**NOTE!**

This parameter is used only if P3.21.2.1 = 2 PID sleep (level).

P3.21.2.3 JOCKEY STOP LEVEL (ID 1676)

Use this parameter to set the level of the PID feedback signal at which the jockey pump stops when the main pump is in the sleep state.

The jockey pump stops when PID Sleep is active and the PID feedback signal goes above the level set in this parameter, or when the PID controller wakes up from sleep mode.

**NOTE!**

This parameter is used only if P3.21.2.1 = 2 PID sleep (level).

10.21.3 PRIMING PUMP

A priming pump is a smaller pump that primes the inlet of the main pump to prevent suction of air.

The priming pump function controls a priming pump with a digital output signal. You can set a delay to start the priming pump before the main pump starts. The priming pump operates continuously while the main pump operates. If the main pump goes into sleep mode, the priming pump also stop for that time. When waking up from sleep mode, the main pump and the priming pump start simultaneously.

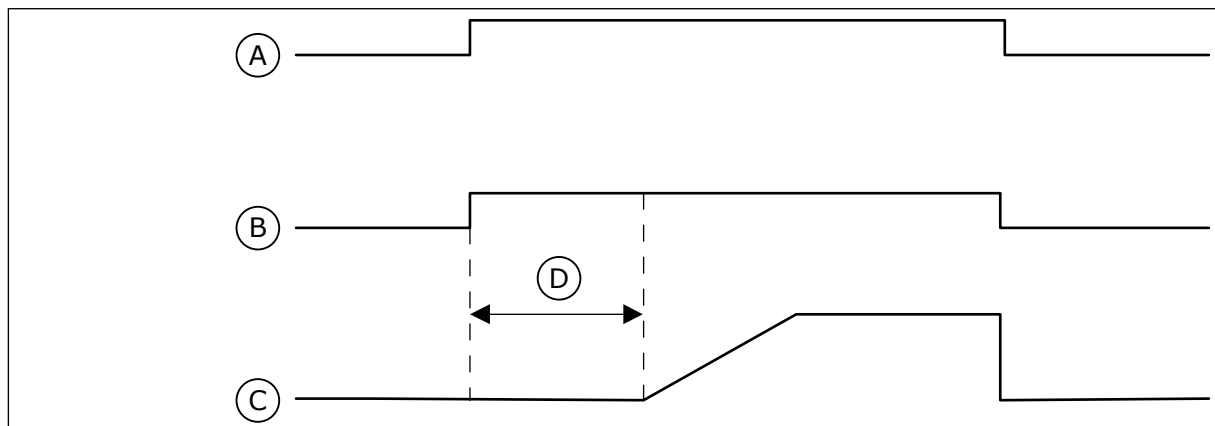

Fig. 107: The Priming pump function

- | | |
|---|----------------------------|
| A. Start Command (Main Pump) | C. Output Freq (Main Pump) |
| B. Priming Pump Control (Digital Output Signal) | D. Priming Time |

P3.21.3.1 PRIMING FUNCTION (ID 1677)

Use this parameter to enable the Priming pump function. A priming pump is a smaller pump that primes the inlet of the main pump to prevent the suction of air. The priming pump function controls a priming pump with a relay output signal.

P3.21.3.2 PRIMING TIME (ID 1678)

Use this parameter to set the time that the priming pump operates before the main pump starts.

10.21.4 ANTI-BLOCKING FUNCTION

The Anti-blocking function makes the pump not to get blocked if the pump is stopped in the Sleep mode for a long time. The pump starts at intervals, while it is in the Sleep mode. You can make a configuration of the interval, runtime and speed for the anti-blocking.

P3.21.4.1 ANTI-BLOCKING INTERVAL (ID 1696)

Use this parameter to set the interval for the Anti-blocking function. This parameter gives the time after which the pump starts at the specified speed (P3.21.4.3 Anti-blocking Frequency) and for the specified quantity time (P3.21.4.2 Anti-blocking Runtime).

The Anti-blocking function can be used in the Single drive and the Multidrive systems only when the pump is in the sleep mode, or in the standby mode (Multidrive system).

The Anti-blocking function is enabled when the value of this parameter is more than 0 and disabled when the value is 0.

P3.21.4.2 ANTI-BLOCKING RUNTIME (ID 1697)

Use this parameter to set the time that the pump operates at the set speed when the Anti-blocking function is activated.

P3.21.4.3 ANTI-BLOCKING FREQUENCY (ID 1504)

Use this parameter to set the frequency reference of the drive that is used when the anti-blocking function is activated.

10.21.5 FROST PROTECTION

Use the Frost protection function to protect the pump from frost damages. If the pump is in sleep mode and the temperature that is measured in the pump goes below the set protection temperature, operate the pump at a constant frequency (that is set in P3.13.10.6 Frost Protection Frequency). To use the function, you must install a temperature transducer or a temperature sensor on the pump covering or on the pipe line near the pump.

P3.21.5.1 FROST PROTECTION (ID 1704)

Use this parameter to enable the Frost Protection function. If the measured temperature of the pump goes below the set level and the drive is in sleep state, the frost protection makes the pump start and operate at a constant frequency.

P3.21.5.2 TEMPERATURE SIGNAL (ID 1705)

Use this parameter to select the source of the temperature signal that is used for the Frost Protection function.

P3.21.5.3 TEMPERATURE SIGNAL MINIMUM (ID 1706)

Use this parameter to set the minimum value of the temperature signal.
For example, a temperature signal range of 4...20mA agrees to the temperature of -50...200°C.

P3.21.5.4 TEMPERATURE SIGNAL MAXIMUM (ID 1707)

Use this parameter to set the maximum value of the temperature signal.
For example, a temperature signal range of 4...20mA agrees to the temperature of -50...200°C.

P3.21.5.5 FROST PROTECTION TEMPERATURE LIMIT (ID 1708)

Use this parameter to set the temperature limit at which the drive starts.
If the temperature of the pump goes below this limit and the drive is in the sleep state, the frost protection function starts the drive.

P3.21.5.6 FROST PROTECTION FREQUENCY (ID 1710)

Use this parameter to set the frequency reference of the drive that is used when the frost protection function is activated.

V3.21.5.7 FROST TEMPERATURE MONITORING (ID 1711)

This monitoring value shows the value of the temperature signal that is used for Frost Protection function.

10.21.6 FLOW SWITCH**P3.21.6.1 FLOW SWITCH (ID 15590)**

Use this parameter to select the digital input signal that is the feedback signal from the Flow Switch.

P3.21.6.2 FLOW SWITCH FAULT DELAY (ID 15585)

Use this parameter to set the time that the feedback signal from Flow Switch must stay inactive before the Flow Switch fault occurs.

P3.21.6.3 FLOW SWITCH BYPASS AT START (ID 15586)

Use this parameter to set the time after which the Flow Switch supervision becomes active at the start-up of the drive.

P3.21.6.4 FLOW SWITCH MINIMUM FREQUENCY (ID 15587)

Use this parameter to set the output frequency level below which the Flow Switch supervision is disabled.

10.22 COUNTERS

The VACON® AC drive has different counters based on the operation time of the drive and the energy consumption. Some of the counters measure total values and some can be reset. The energy counters measure the energy that is taken from the supply network. The other counters are used to measure, for example, the operation time of the drive or the runtime of the motor.

It is possible to monitor all the counter values from the PC, keypad or fieldbus. If you use the keypad or the PC, you can monitor the counter values in the Diagnostics menu. If you use fieldbus, you can read the counter values with the ID numbers. In this chapter, you find data on these ID numbers.

10.22.1 OPERATING TIME COUNTER

It is not possible to reset the operating time counter of the control unit. The counter is in the submenu Total counters. The value of the counter has 5 different 16-bit values. To read the value of the counter through fieldbus, use these ID numbers.

- **ID 1754 Operating Time Counter (years)**
- **ID 1755 Operating Time Counter (days)**
- **ID 1756 Operating Time Counter (hours)**
- **ID 1757 Operating Time Counter (minutes)**
- **ID 1758 Operating Time Counter (seconds)**

Example: You receive the value *1a 143d 02:21* of the operating time counter from the fieldbus.

- ID1754: 1 (years)
- ID1755: 143 (days)
- ID1756: 2 (hours)
- ID1757: 21 (minutes)
- ID1758: 0 (seconds)

10.22.2 OPERATING TIME TRIP COUNTER

The operating time trip counter of the control unit can be reset. It is in the submenu Trip counters. It is possible to reset the counter with the PC, the control panel, or the fieldbus. The value of the counter has 5 different 16-bit values. To read the value of the counter through fieldbus, use these ID numbers.

- **ID 1766 Operating Time Trip Counter (years)**
- **ID 1767 Operating Time Trip Counter (days)**
- **ID 1768 Operating Time Trip Counter (hours)**
- **ID 1769 Operating Time Trip Counter (minutes)**
- **ID 1770 Operating Time Trip Counter (seconds)**

Example: You receive the value *1a 143d 02:21* of the operating time trip counter from the fieldbus.

- ID1766: 1 (years)
- ID1767: 143 (days)
- ID1768: 2 (hours)
- ID1769: 21 (minutes)
- ID1770: 0 (seconds)

ID 2311 OPERATING TIME TRIP COUNTER RESET

You can reset the operating time trip counter with the PC, the control panel, or the fieldbus. If you use the PC or the control panel, reset the counter in the Diagnostics menu.

If you use the fieldbus, to reset the counter, set a rising edge (0 => 1) to ID2311 Operating Time Trip Counter Reset.

10.22.3 RUN TIME COUNTER

The run time counter of the motor cannot be reset. It is in the submenu Total counters. The value of the counter has 5 different 16-bit values. To read the value of the counter through fieldbus, use these ID numbers.

- **ID 1772 Run Time Counter (years)**
- **ID 1773 Run Time Counter (days)**
- **ID 1774 Run Time Counter (hours)**
- **ID 1775 Run Time Counter (minutes)**
- **ID 1776 Run Time Counter (seconds)**

Example: You receive the value *1a 143d 02:21* of the run time counter from the fieldbus.

- ID1772: 1 (years)
- ID1773: 143 (days)
- ID1774: 2 (hours)
- ID1775: 21 (minutes)
- ID1776: 0 (seconds)

10.22.4 POWER ON TIME COUNTER

The power on time counter of the power unit is in the submenu Total counters. It is not possible to reset the counter. The value of the counter has 5 different 16-bit values. To read the value of the counter through fieldbus, use these ID numbers.

- **ID 1777 Power On Time Counter (years)**
- **ID 1778 Power On Time Counter (days)**
- **ID 1779 Power On Time Counter (hours)**
- **ID 1780 Power On Time Counter (minutes)**
- **ID 1781 Power On Time Counter (seconds)**

Example: You receive the value *1a 240d 02:18* of the power on time counter from the fieldbus.

- ID1777: 1 (years)
- ID1778: 240 (days)
- ID1779: 2 (hours)
- ID1780: 18 (minutes)
- ID1781: 0 (seconds)

10.22.5 ENERGY COUNTER

The energy counter counts the total quantity of energy that the drive gets from the supply network. The counter cannot be reset. To read the value of the counter through fieldbus, use these ID numbers.

ID 2291 Energy Counter

The value has always 4 digits. The format and the unit of the counter change to agree with the energy counter value. See the example below.

Example:

- 0.001 kWh
- 0.010 kWh
- 0.100 kWh
- 1.000 kWh
- 10.00 kWh
- 100.0 kWh
- 1.000 MWh
- 10.00 MWh
- 100.0 MWh
- 1.000 GWh
- etc...

ID2303 Energy Counter Format

The energy counter format gives the position of the decimal point in the value of the Energy Counter.

- 40 = 4 digits, 0 fractional digits
- 41 = 4 digits, 1 fractional digit
- 42 = 4 digits, 2 fractional digits
- 43 = 4 digits, 3 fractional digits

Example:

- 0.001 kWh (Format = 43)
- 100.0 kWh (Format = 41)
- 10.00 MWh (Format = 42)

ID2305 Energy Counter Unit

The energy counter unit gives the unit for the value of the Energy Counter.

- 0 = kWh
- 1 = MWh
- 2 = GWh
- 3 = TWh
- 4 = PWh

Example: If you receive the value *4500* from ID2291, the value *42* from ID2303, and the value *0* from ID2305, the result is 45.00 kWh.

10.22.6 ENERGY TRIP COUNTER

The energy trip counter counts the quantity of energy that the drive gets from the supply network. The counter is in the submenu Trip counters. You can reset the counter with the PC, the control panel, or the fieldbus. To read the value of the counter through fieldbus, use these ID numbers.

ID 2296 Energy Trip Counter

The value has always 4 digits. The format and the unit of the counter change to agree with the energy trip counter value. See the example below. You can monitor the energy counter format and unit with ID2307 Energy Trip Counter Format and ID2309 Energy trip Counter unit.

Example:

- 0.001 kWh
- 0.010 kWh
- 0.100 kWh
- 1.000 kWh
- 10.00 kWh
- 100.0 kWh
- 1.000 MWh
- 10.00 MWh
- 100.0 MWh
- 1.000 GWh
- etc...

ID2307 Energy Trip Counter Format

The energy trip counter format gives the position of the decimal point in the value of the Energy Trip Counter.

- 40 = 4 digits, 0 fractional digits
- 41 = 4 digits, 1 fractional digit
- 42 = 4 digits, 2 fractional digits
- 43 = 4 digits, 3 fractional digits

Example:

- 0.001 kWh (Format = 43)
- 100.0 kWh (Format = 41)
- 10.00 MWh (Format = 42)

ID2309 Energy Trip Counter Unit

The energy trip counter unit gives the unit for the value of the Energy Trip Counter.

- 0 = kWh
- 1 = MWh
- 2 = GWh
- 3 = TWh
- 4 = PWh

ID2312 Energy Trip Counter Reset

To reset the energy trip counter, use the PC, the control panel, or the fieldbus. If you use the PC or the control panel, reset the counter in the Diagnostics menu. If you use the fieldbus, set a rising edge to ID2312 Energy Trip Counter Reset.

10.23 ADVANCED HARMONIC FILTER

P3.23.1 CAPACITOR DISCONNECTION LIMIT (ID 15510)

Use this parameter to set the disconnection limit for the advanced harmonic filter. The value is in percentage of the drive nominal power.

P3.23.2 CAPACITOR DISCONNECTION HYSTERESIS (ID 15511)

Use this parameter to set the disconnection hysteresis for the advanced harmonic filter. The value is in percentage of the drive nominal power.

P3.23.3 AHF OVER TEMPERATURE (ID 15513)

Use this parameter to set the digital input signal that activates AHF Over Temp (fault ID 1118).

P3.23.4 AHF FAULT RESPONSE (ID 15512)

Use this parameter to select the response of the AC drive to an AHF Over Temp fault.

11 FAULT TRACING

When the control diagnostics of the AC drive find an unusual condition in the operation of the drive, the drive shows a notification about it. You can see the notification on the display of the control panel. The display shows the code, the name and a short description of the fault or alarm.

The source info tells you the source of the fault, what caused it, where it occurred, and other data.

There are 3 different types of notification.

- An info does not have an effect the operation of the drive. You must reset the info.
- An alarm informs you of unusual operation on the drive. It does not stop the drive. You must reset the alarm.
- A fault stops the drive. You must reset the drive and find a solution to the problem.

You can program different responses for some faults in the application. See more in Chapter 5.9 Group 3.9: Protections.

Reset the fault with the Reset button on the keypad, or through the I/O terminal, fieldbus or the PC tool. The faults stay in the Fault history where you can go and examine them. See the different fault codes in Chapter 11.3 Fault codes.

Before you contact the distributor or the factory because of unusual operation, prepare some data. Write down all the texts on the display, the fault code, the fault ID, the source info, the Active Faults list and the Fault History.

11.1 A FAULT COMES INTO VIEW

When the drive shows a fault and stops, examine the cause of fault, and reset the fault.

There are 2 procedures to reset a fault: with the Reset button and with a parameter.

RESETTING WITH THE RESET BUTTON

- 1 Push the Reset button on the keypad for 2 secods.

RESETTING WITH A PARAMETER IN THE GRAPHICAL DISPLAY

- 1 Go to the Diagnostics Menu.

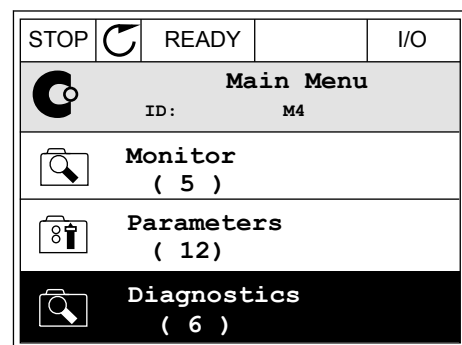

- Go to the submenu Reset faults.

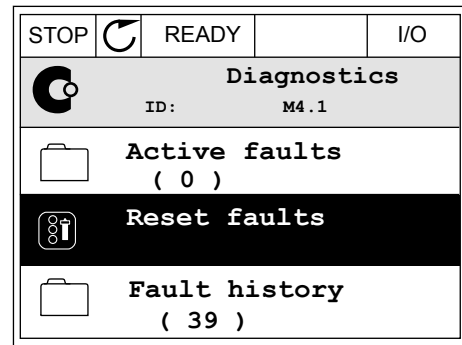

- Make a selection of the parameter Reset Faults.

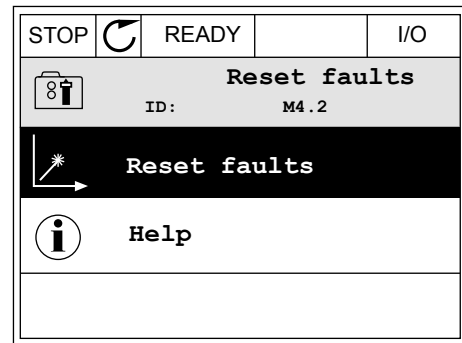

RESETTING WITH A PARAMETER IN THE TEXT DISPLAY

- Go to the Diagnostics menu.



- Use the arrow buttons Up and Down to find the parameter Reset Faults.

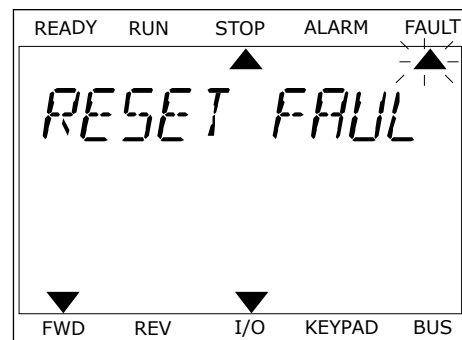

- 3 Make a selection of the value Yes and push OK.

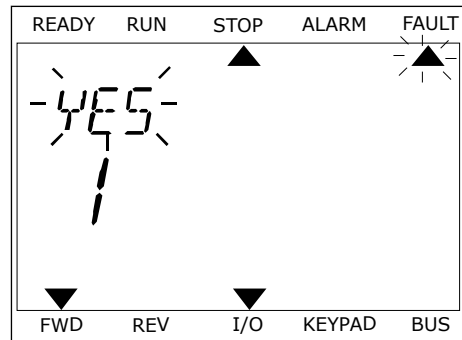

11.2 FAULT HISTORY

In the Fault history, you can find more data on the faults. There is a maximum number of 40 faults in the Fault history.

EXAMINING THE FAULT HISTORY IN THE GRAPHICAL DISPLAY

- 1 To see more data on a fault, go to Fault history.

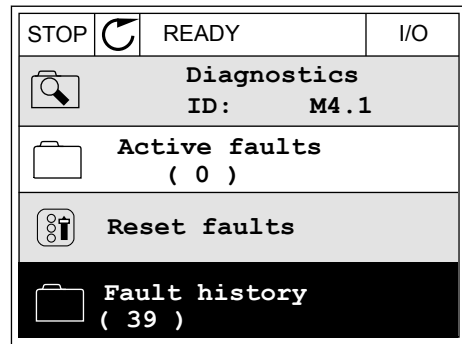

- 2 To examine the data of a fault, push the Arrow button Right.

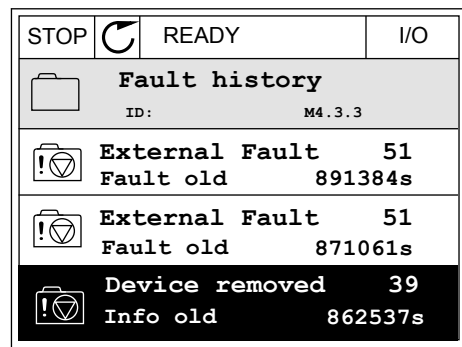

- You see the data in a list.

STOP	READY	I/O
Fault history		
ID: M4.3.3.2		
Code	39	
ID	380	
State	Info old	
Date	7.12.2009	
Time	04:46:33	
Operating time	862537s	
Source 1		
Source 2		
Source 3		

EXAMINING THE FAULT HISTORY IN THE TEXT DISPLAY

- Push OK to go to Fault history.

READY	RUN	STOP	ALARM	FAULT
▲				
FAULT HIST				
M4.3				
▼				
FWD	REV	I/O	KEYPAD	BUS

- To examine the data of a fault, push OK again.

READY	RUN	STOP	ALARM	FAULT
▲				
COMMUNICAT				
M4.3 1				
▼				
FWD	REV	I/O	KEYPAD	BUS

3 Use the arrow button down to examine all the data.

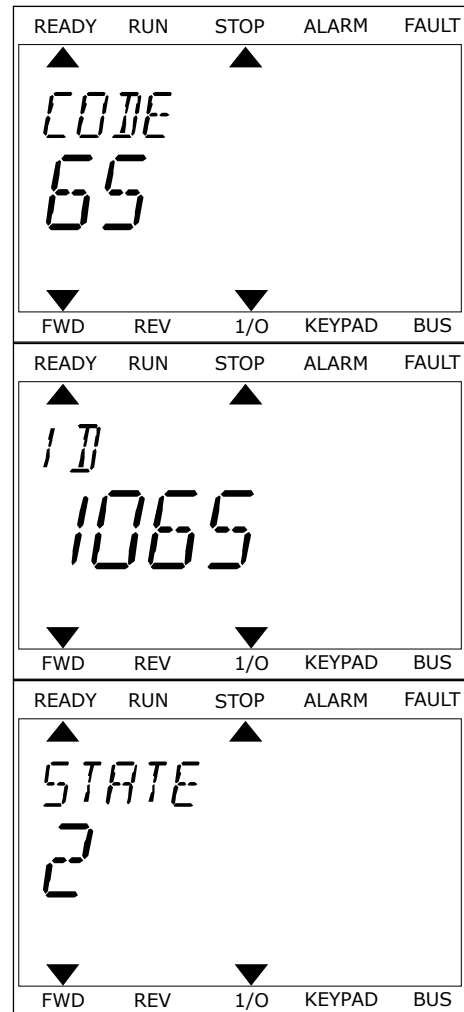

11.3 FAULT CODES

Fault code	Fault ID	Fault name	Possible cause	How to correct the fault
1	1	Overcurrent (hardware fault)	There is too high a current (>4*I _H) in the motor cable. Its cause can be 1 of these. <ul style="list-style-type: none"> • a sudden heavy load increase • a short circuit in the motor cables • the motor is not the correct type • the parameter settings are not properly made 	Do a check of the loading. Do a check of the motor. Do a check of the cables and connections. Make an identification run. Set the acceleration time longer (P3.4.1.2 and P3.4.2.2).
	2	Overcurrent (software fault)		
2	10	Overvoltage (hardware fault)	The DC-link voltage is higher than the limits. <ul style="list-style-type: none"> • the deceleration time is too short • high overvoltage spikes in the supply 	Set the deceleration time longer (P3.4.1.3 and P3.4.2.3). Activate the overvoltage controller. Do a check of the input voltage.
	11	Overvoltage (software fault)		
3	20	Earth fault (hardware fault)	The measurement of current tells that the sum of the motor phase current is not 0. <ul style="list-style-type: none"> • an insulation malfunction in the cables or the motor • a filter (du/dt, sinus) malfunction 	Do a check of the motor cables and the motor. Do a check of the filters.
	21	Earth fault (software fault)		
5	40	Charging switch	The charging switch is closed and the feedback information is OPEN. <ul style="list-style-type: none"> • operation malfunction • defective component 	Reset the fault and restart the drive. Do a check of the feedback signal and the cable connection between the control board and the power board. If the fault occurs again, ask instructions from the distributor near to you.
7	60	Saturation	<ul style="list-style-type: none"> • Defective IGBT • de-saturation short circuit in the IGBT • a short circuit or an overload in the brake resistor 	This fault cannot be reset from the control panel. Make a power down of the drive. DO NOT RESTART THE DRIVE or CONNECT THE POWER! Ask instructions from the factory.

Fault code	Fault ID	Fault name	Possible cause	How to correct the fault
8	600	System fault	There is no communication between the control board and the power.	Reset the fault and restart the drive. Download the newest software from the Danfoss Drives website. Update the drive with it. If the fault occurs again, ask instructions from the distributor near to you.
	601			
	602		Defective component. Operation malfunction.	
	603		Defective component. Operation malfunction. The voltage of auxiliary power in the power unit is too low.	
	604		Defective component. Operation malfunction. Output phase voltage does not agree to the reference. Feedback fault.	
	605		Defective component. Operation malfunction.	
	606		The software of the control unit is not compatible with the software of the power unit.	
	607		The software version cannot be read. There is no software in the power unit. Defective component. Operation malfunction (a problem in the power board or the measurement board).	
	608		A CPU overload.	
	609		Defective component. Operation malfunction.	Reset the fault and make a power down of the drive twice. Download the newest software from the Danfoss Drives website. Update the drive with it.

Fault code	Fault ID	Fault name	Possible cause	How to correct the fault
8	610	System fault	Defective component. Operation malfunction.	Reset the fault and restart. Download the newest software from the Danfoss Drives website. Update the drive with it. If the fault occurs again, ask instructions from the distributor near to you.
	614		Configuration error. Software error. Defective component (a defective control board). Operation malfunction.	
	647		Defective component. Operation malfunction.	
	648		Operation malfunction. The system software is not compatible with the application.	
	649		A resource overload. A malfunction in the loading, restoring or saving a parameter.	Load the factory default settings. Download the newest software from the Danfoss Drives website. Update the drive with it.

Fault code	Fault ID	Fault name	Possible cause	How to correct the fault
8	667	System fault	Ethernet PHY is not recognised or it is in the wrong state.	Reset the fault and restart the AC drive. Download the newest software from the Danfoss Drives website. Update the drive with it. If the fault occurs again, ask instructions from your nearest distributor.
	670		The output voltage is too low because of overload, a defective component, or a shortcut.	Do a check of the loading of the auxiliary output. Reset the fault and restart the AC drive. Download the newest software from the Danfoss Drives website. Update the drive with it. If the fault occurs again, ask instructions from your nearest distributor.
	827		Invalid/incorrect licence key provided (via keypad or VCX). The licence key is incorrect or not for this drive.	Reset the fault and restart the AC drive. Enter the licence key to the AC drive again. Download the newest software from the Danfoss Drives website. Update the drive with it. If the fault occurs again, ask instructions from your nearest distributor.
	828		The entered licence key was accepted and stored to the drive.	-
	829		New licences have been taken into use since the previous start-up.	-
	830		Licences have been removed from the drive.	-

Fault code	Fault ID	Fault name	Possible cause	How to correct the fault
9	80	Undervoltage (fault)	<p>The DC link voltage is lower than the limits.</p> <ul style="list-style-type: none"> • The supply voltage is too low • a defective component • a defective input fuse • the external charge switch is not closed <p>NOTE!</p> <p>This fault becomes active only if the drive is in Run state.</p>	<p>If there is a temporary supply voltage break, reset the fault and restart the drive.</p> <p>Do a check of the supply voltage. If the supply voltage is sufficient, there is an internal fault.</p> <p>Examine the electrical network for fault.</p> <p>Ask instructions from the distributor near to you.</p>
10	91	Input phase	<ul style="list-style-type: none"> • supply voltage malfunction • a defective fuse or malfunction in the supply cables <p>The load must be a minimum of 10-20% for the supervision to work.</p>	<p>Do a check of the supply voltage, the fuses and supply cable, the rectifying bridge and the gate control of the thyristor (MR6->).</p>
11	100	Output phase supervision	<p>The measurement of current tells that there is no current in 1 motor phase.</p> <ul style="list-style-type: none"> • a motor or motor cables malfunction • a filter (du/dt, sinus) malfunction 	<p>Do a check of the motor cable and the motor.</p> <p>Do a check of the du/dt or sinus filter.</p>
13	120	AC drive undertemperature (fault)	<p>The temperature is too low in the heatsink of the power unit or in the power board.</p>	<p>The ambient temperature is too low for the drive. Move the drive in a warmer position.</p>

Fault code	Fault ID	Fault name	Possible cause	How to correct the fault
14	130	AC drive overtemperature (fault, heatsink)	The temperature is too low in the heatsink of the power unit or in the power board. The temperature limits of the heatsink are different in all the frames.	Do a check of the actual quantity and flow of cooling air. Examine the heatsink for dust. Do a check of the ambient temperature. Make sure that the switching frequency is not too high in relation to the ambient temperature and the motor load. Do a check of the cooling fan.
	131	AC drive overtemperature (alarm, heat-sink)		
	132	AC drive overtemperature (fault, board)		
	133	AC drive overtemperature (alarm, board)		
	136	Overvoltage protection circuit temperature (alarm)	Too high an output capacitance or an earth fault in the floating network.	Do a check of the cables and the motor.
	137	Overvoltage protection circuit temperature (fault)	Too high an output capacitance or an earth fault in the floating network.	Do a check of the cables and the motor.
15	140	Motor stall	The motor stalled.	Do a check of the motor and the load.
16	150	Motor overtemperature	The load is too heavy on the motor.	Decrease the motor load. If there is no motor overload, do a check of the motor thermal protection parameters (parameter group 3.9 Protections).
17	160	Motor underload	The load is not sufficient on the motor.	Do a check of the load. Do a check of the parameters. Do a check of the du/dt and sinus filters.
19	180	Power overload (short-time supervision)	The power of the drive is too high.	Decrease the load. Examine the dimensioning of the drive. Examine if it is too small for the load.
	181	Power overload (long-time supervision)		
25	240	Motor control fault	This fault is available only if you use a customer-specific application. A malfunction in the start angle identification. <ul style="list-style-type: none"> The rotor moves during identification. The new angle does not agree with the old value. 	Reset the fault and restart the drive. Increase the identification current. See the fault history source for more information.
	241			

Fault code	Fault ID	Fault name	Possible cause	How to correct the fault
26	250	Startup prevented	It is not possible to do a startup of the drive. When the Run request is ON, a new software (a firmware or an application), a parameter setting or other file that effects the operation of the drive, is loaded to the drive.	Reset the fault and stop the drive. Load the software and start the drive.
29	280	Atex thermistor	The ATEX thermistor tells that there is an overtemperature.	Reset the fault. Do a check of the thermistor and its connections.
30	290	Safe Off	The safe off signal A does not let you to set the drive to the READY state.	Reset the fault and restart the drive. Do a check of the signals from the control board to the power unit and the D connector.
	291	Safe Off	The safe off signal B does not let you to set the drive to the READY state.	
	500	Safety configuration	The safety configuration switch was installed.	Remove the safety configuration switch from the control board.
	501	Safety configuration	There are too many STO option boards. It is possible to have only 1.	Keep 1 of the STO option boards. Remove the others. See the safety manual.
	502	Safety configuration	The STO option board was installed in an incorrect slot.	Put the STO option board into the correct slot. See the safety manual.
	503	Safety configuration	There is no safety configuration switch on the control board.	Install the safety configuration switch on the control board. See the safety manual.
	504	Safety configuration	The safety configuration switch was installed incorrectly on the control board.	Install the safety configuration switch into the correct position on the control board. See the safety manual.
	505	Safety configuration	The safety configuration switch was installed incorrectly on the STO option board.	Do a check of the installation of the safety configuration switch on the STO option board. See the safety manual.
	506	Safety configuration	There is no communication with the STO option board.	Do a check of the installation of the STO option board. See the safety manual.
507	Safety configuration	The STO option board is not compatible with the hardware.	Reset the drive and restart it. If the fault occurs again, ask instructions from your nearest distributor.	

Fault code	Fault ID	Fault name	Possible cause	How to correct the fault
30	520	Safety diagnostics	The STO inputs have a different status.	Do a check of the external safety switch. Do a check of the input connection and cable of the safety switch. Reset the drive and restart. If the fault occurs again, ask instructions from your nearest distributor.
	521		A malfunction in the ATEX thermistor diagnostic. There is no connection in the ATEX thermistor input.	Reset the drive and restart. If the fault occurs again, change the option board.
	522		A short circuit in the connection of the ATEX thermistor input.	Do a check of the ATEX thermistor input connection. Do a check of the external ATEX connection. Do a check of the external ATEX thermistor.
	530	Safe torque off	An emergency stop was connected or some other STO operation was activated.	When the STO function is activated, the drive is in safe state.
32	311	Fan cooling	The fan speed does not agree to the speed reference accurately, but the drive operates correctly. This fault shows only in the MR7 and in the drives that larger than MR7.	Reset the fault and restart the drive. Clean or replace the fan.
	312	Fan cooling	The fan life time (that is, 50,000 h) is complete.	Replace the fan and reset the life time counter of the fan.
33	320	Fire mode enabled	The Fire mode of the drive is enabled. The protections of the drive are not used. This alarm is reset automatically when Fire mode is disabled.	Do a check of the parameter settings and the signals. Some of the protections of the drive are disabled.

Fault code	Fault ID	Fault name	Possible cause	How to correct the fault
37	361	Device changed (same type)	The power unit was replaced by a new one that has the same size. The device is ready to be used. The parameters are available in the drive.	Reset the fault. The drive reboots after you reset the fault.
	362	Device changed (same type)	The option board in slot B was replaced by a new one that you have used before in the same slot. The device is ready to be used.	Reset the fault. The drive starts to use the old parameter settings.
	363	Device changed (same type)	The same cause as in ID362, but refers to Slot C.	
	364	Device changed (same type)	The same cause as in ID362, but refers to Slot D.	
	365	Device changed (same type)	The same cause as in ID362, but refers to Slot E.	
38	372	Device added (same type)	An option board was put into slot B. You have used the option board before in the same slot. The device is ready to be used.	The device is ready to be used. The drive starts to use the old parameter settings.
	373	Device added (same type)	The same cause as in ID372, but refers to Slot C.	
	374	Device added (same type)	The same cause as in ID372, but refers to Slot D.	
	375	Device added (same type)	The same cause as in ID372, but refers to Slot E.	
39	382	Device removed	An option board was removed from slot A or B.	The device is not available. Reset the fault.
	383	Device removed	The same cause as in ID380, but refers to Slot C	
	384	Device removed	The same cause as in ID380, but refers to Slot D	
	385	Device removed	The same cause as in ID380, but refers to Slot E	
40	390	Device unknown	An unknown device was connected (the power unit/ option board)	The device is not available. If the fault occurs again, ask instructions from your nearest distributor.

Fault code	Fault ID	Fault name	Possible cause	How to correct the fault
41	400	IGBT temperature	<p>The calculated IGBT temperature is too high.</p> <ul style="list-style-type: none"> the motor load is too high the ambient temperature is too high hardware malfunction 	<p>Do a check of the parameter settings.</p> <p>Examine the actual quantity and flow of cooling air.</p> <p>Do a check of the ambient temperature.</p> <p>Examine the heatsink for dust.</p> <p>Make sure that the switching frequency is not too high in relation to the ambient temperature and the motor load.</p> <p>Do a check of the cooling fan.</p> <p>Make an identification run.</p>
44	431	Device changed (different type)	There is a new power unit of a different type. Parameters are not available in the settings.	<p>Reset the fault.</p> <p>The drive reboots after you reset the fault.</p> <p>Set the power unit parameters again.</p>
	433	Device changed (different type)	The option board in slot C was replaced by a new one that you have not used before in the same slot. No parameter settings are saved.	Reset the fault. Set the option board parameters again.
	434	Device changed (different type)	The same cause as in ID433, but refers to Slot D.	
	435	Device changed (different type)	The same cause as in ID433, but refers to Slot D.	
45	441	Device added (different type)	There is a new power unit of a different type. Parameters are not available in the settings.	<p>Reset the fault.</p> <p>The drive reboots after you reset the fault.</p> <p>Set the power unit parameters again.</p>
	443	Device added (different type)	A new option board, that you have not used before in the same slot, was put in slot C. No parameter settings are saved.	Set the option board parameters again.
	444	Device added (different type)	The same cause as in ID443, but refers to Slot D.	
	445	Device added (different type)	The same cause as in ID443, but refers to Slot E.	
46	662	Real Time Clock	The voltage of the RTC battery is low.	Replace the battery.

Fault code	Fault ID	Fault name	Possible cause	How to correct the fault
47	663	Software updated	The software of the drive was updated, the full software package or an application.	No steps are necessary.
50	1050	AI low fault	1 or more of the available analogue input signals is below 50% of the minimum signal range. A control cable is defective or loose. A malfunction in a signal source.	Replace the defective parts. Do a check of the analogue input circuit. Make sure that parameter AI1 Signal Range is set correctly.
51	1051	Device external fault	The digital input signal that is set with parameter P3.5.1.11 or P3.5.1.12 was activated.	This is a user-specified fault. Do a check of the digital inputs and schematics.
52	1052	Keypad communication fault	The connection between the control panel and the drive is defective.	Do a check of the control panel connection and the control panel cable if you have it.
	1352			
53	1053	Fieldbus communication fault	The data connection between the fieldbus master and the fieldbus board is defective.	Do a check of the installation and fieldbus master.
54	1354	Slot A fault	A defective option board or slot	Do a check of the board and the slot. Ask instructions from your nearest distributor.
	1454	Slot B fault		
	1554	Slot C fault		
	1654	Slot D fault		
	1754	Slot E fault		

Fault code	Fault ID	Fault name	Possible cause	How to correct the fault
57	1057	Identification	There was a failure in the identification run.	Make sure that the motor is connected to the drive. Make sure that there is no load on the motor shaft. Make sure that the start command is not removed before the identification run is complete.
	1157		During the identification run drive was not able to reach required frequency reference.	Make sure that minimum and maximum frequency references are set correctly. Too low maximum frequency might prevent drive from reaching required frequency.
	1257		During the identification run drive was not able to reach required frequency reference.	Make sure that acceleration time is set correctly. Too long acceleration time might prevent drive from reaching required frequency in 40 seconds.
	1357		During the identification run drive was not able to reach required frequency reference.	Make sure that current, torque and power limits of the drive are set correctly. Too low limit settings might prevent drive from reaching required frequency.
63	1063	Quick Stop fault	The Quick stop function is activated	Find the cause for the quick stop activation. After you find it, correct it. Reset the fault and restart the drive. See parameter P3.5.1.26 and the quick stop parameters.
	1363	Quick Stop alarm		
65	1065	PC communication fault	The data connection between the PC and the drive is defective	Do a check of the installation, cable and terminals between the PC and the drive.
66	1366	Thermistor input 1 fault	The motor temperature increased.	Do a check of the motor cooling and the load. Do a check of the thermistor connection. If the thermistor input is not used, you have to short-circuit it. Ask instructions from your nearest distributor.
	1466	Thermistor input 2 fault		
	1566	Thermistor input 3 fault		

Fault code	Fault ID	Fault name	Possible cause	How to correct the fault
68	1301	Maintenance counter 1 alarm	The value of the maintenance counter is higher than the alarm limit.	Do the necessary maintenance. Reset the counter. See parameter B3.16.4 or P3.5.1.40.
	1302	Maintenance counter 1 fault	The value of the maintenance counter is higher than the fault limit.	
	1303	Maintenance counter 2 alarm	The value of the maintenance counter is higher than the alarm limit.	
	1304	Maintenance counter 2 fault	The value of the maintenance counter is higher than the fault limit.	
69	1310	Fieldbus communication fault	The ID number that is used to map the values to Fieldbus Process Data Out is not valid.	Do a check of the parameters in the Fieldbus Data Mapping menu.
	1311		It is not possible to convert 1 or more values for Fieldbus Process Data Out.	The type of the value is not specified. Do a check of the parameters in the Fieldbus Data Mapping menu.
	1312		There is an overflow when the values for Fieldbus Process Data Out (16-bit) are mapped and converted.	Do a check of the parameters in the Fieldbus Data Mapping menu.
76	1076	Start prevented	The start command is blocked to prevent the accidental rotation of the motor during the first power-up.	Reset the drive to start the correct operation. The parameter settings tell if it is necessary to restart the drive.
77	1077	>5 connections	There are more than 5 active fieldbus or PC tool connections. You can use only 5 connections at the same time.	Keep 5 active connections. Remove the other connections.
100	1100	Soft fill timeout	There is a timeout in the Soft fill function in the PID controller. The drive did not go to the process value in the time limit. A pipe that broke can be the cause.	Do a check of the process. Do a check of the parameters in the menu M3.13.8.

Fault code	Fault ID	Fault name	Possible cause	How to correct the fault
101	1101	Feedback supervision fault (PID1)	The PID controller: the feedback value is not in the supervision limits (P3.13.6.2 and P3.13.6.3) and the delay (P3.13.6.4), if you set the delay.	Do a check of the process. Do a check of the parameter settings, the supervision limits and the delay.
105	1105	Feedback supervision fault (ExtPID)	The external PID controller: the feedback value is not in the supervision limits (P3.14.4.2 and P3.14.4.3) and the delay (P3.14.4.4), if you set the delay.	
109	1109	Input pressure supervision	The supervision signal of the input pressure (P3.13.9.2) is lower than the alarm limit (P3.13.9.7).	Do a check of the process. Do a check of the parameters in menu M3.13.9. Do a check of the input pressure sensor and connections.
	1409		The supervision signal of the input pressure (P3.13.9.2) is lower than the fault limit (P3.13.9.8).	
111	1315	Temperature fault 1	1 or more of the temperature input signals (set in P3.9.6.1) is higher than the alarm limit (P3.9.6.2).	Find the cause of the temperature rise. Do a check of the temperature sensor and connections. If no sensor is connected, make sure that the temperature input is hardwired. See the option board manual for more information.
	1316		1 or more of the temperature input signals (set in P3.9.6.1) is higher than the fault limit (P3.9.6.3).	
112	1317	Temperature fault 2	1 or more of the temperature input signals (set in P3.9.6.5) is higher than the fault limit (P3.9.6.6).	
	1318		1 or more of the temperature input signals (set in P3.9.6.5) is higher than the fault limit (P3.9.6.7).	
113	1113	Pump running time	In the Multi-pump system, 1 or more of the pump runtime counters is above a user-specified alarm limit.	Do the necessary maintenance actions, reset the runtime counter and reset the alarm. See Pump running time counters.
	1313		In the Multi-pump system, 1 or more of the pump runtime counters is above a user-specified alarm limit	

Fault code	Fault ID	Fault name	Possible cause	How to correct the fault
118	1118	AHF Over Temp	The advanced harmonic filter function has caused an overtemperature fault through a digital input.	Do a check of the advanced harmonic filter function.
300	700	Unsupported	The application is not compatible (it is unsupported).	Replace the application.
	701		The option board or the slot is not compatible (it is unsupported).	Remove the option board.

12 APPENDIX 1

12.1 THE DEFAULT VALUES OF PARAMETERS IN THE DIFFERENT APPLICATIONS

The explanation of symbols in the table

A = Standard application

B = HVAC application

C = PID control application

D = Multi-pump (single drive) application

E = Multi-pump (multidrive) application

Table 123: The default values of parameters in the different applications

Index	Parameter	Default					Unit	ID	Description
		A	B	C	D	E			
P3.2.1	Remote Control Place	0	0	0	0	0		172	0 = I/O Control
P3.2.2	Local/Remote	0	0	0	0	0		211	0 = Remote
P3.2.6	I/O A Logic	2	2	2	0	0		300	0 = Forw-Back 2 = Forw-Back (edge)
P3.2.7	I/O B Logic	2	2	2	2	2		363	2 = Forw-Back (edge)
P3.3.1.5	I/O A Reference Selection	6	6	7	7	7		117	6 = AI1 + AI2 7 = PID
P3.3.1.6	I/O B Reference Selection	4	4	4	4	4		131	4 = AI1
P3.3.1.7	Keypad Reference Selection	2	2	2	2	2		121	2 = Keypad Reference
P3.3.1.10	Fieldbus Reference Selection	3	3	3	3	3		122	3 = Fieldbus Reference
P3.3.3.1	Preset Frequency Mode	0	0	0	0	0		182	0 = Binary Coded
P3.3.3.3	Preset Frequency 1	10.0	10.0	10.0	10.0	10.0	Hz	105	
P3.3.3.4	Preset Frequency 2	15.0	15.0	15.0	15.0	15.0	Hz	106	
P3.3.3.5	Preset Frequency 3	20.0	20.0	20.0	20.0	20.0	Hz	126	
P3.3.6.1	Flushing Reference Activation	0	0	0	0	101		530	0 = DigIN Slot0.1 101 = DigIN SlotA.2
P3.3.6.2	Flushing Reference	0	0	0	0	0	Hz	1239	
P3.5.1.1	Ctrl Signal 1 A	100	100	100	100	100		403	100 = DigIN SlotA.1

Table 123: The default values of parameters in the different applications

Index	Parameter	Default					Unit	ID	Description
		A	B	C	D	E			
P3.5.1.2	Ctrl Signal 2 A	101	101	0	0	0		404	0 = DigIN Slot0.1 101 = DigIN SlotA.2
P3.5.1.4	Ctrl Signal 1 B	0	0	103	101	0		423	0 = DigIN Slot0.1 101 = DigIN SlotA.2 103 = DigIN SlotA.4
P3.5.1.7	I/O B Control Force	0	0	105	102	0		425	0 = DigIN Slot0.1 102 = DigIN SlotA.3 105 = DigIN SlotA.6
P3.5.1.8	I/O B Reference Force	0	0	105	102	0		343	0 = DigIN Slot0.1 102 = DigIN SlotA.3 105 = DigIN SlotA.6
P3.5.1.9	Fieldbus Control Force	0	0	0	0	0		411	
P3.5.1.10	Keypad Control Force	0	0	0	0	0		410	
P3.5.1.11	External Fault (Close)	102	102	101	0	105		405	0 = DigIN Slot0.1 101 = DigIN SlotA.2 102 = DigIN SlotA.3 105 = DigIN SlotA.6
P3.5.1.13	Fault Reset (Close)	105	105	102	0	103		414	0 = DigIN Slot0.1 102 = DigIN SlotA.3 103 = DigIN SlotA.4 105 = DigIN SlotA.6
P3.5.1.21	Preset Freq Selection 0	103	103	104	0	0		419	0 = DigIN Slot0.1 103 = DigIN SlotA.4 104 = DigIN SlotA.5
P3.5.1.22	Preset Freq Selection 1	104	104	0	0	0		420	0 = DigIN Slot0.1 104 = DigIN SlotA.5

Table 123: The default values of parameters in the different applications

Index	Parameter	Default					Unit	ID	Description
		A	B	C	D	E			
P3.5.1.23	Preset Freq Selection 2	0	0	0	0	0		421	
P3.5.1.31	PID Setpoint Selection	0	0	0	0	102		1047	0 = DigIN Slot0.1 102 = DigIN SlotA.3
P3.5.1.36	Flushing Reference Activation	0	0	0	0	101		530	0 = DigIN Slot0.1 101 = DigIN SlotA.2
P3.5.1.42	Pump 1 Interlock	0	0	0	103	0		426	0 = DigIN Slot0.1 103 = DigIN SlotA.4
P3.5.1.43	Pump 2 Interlock	0	0	0	104	0		427	0 = DigIN Slot0.1 104 = DigIN SlotA.5
P3.5.1.44	Pump 3 Interlock	0	0	0	105	0		428	0 = DigIN Slot0.1 105 = DigIN SlotA.6
P3.5.2.1.1	AI1 Signal Selection	100	100	100	100	100		377	100 = AnIN SlotA.1
P3.5.2.1.2	AI1 Filter Time	0.1	0.1	0.1	0.1	0.1	s	378	
P3.5.2.1.3	AI1 Signal Range	0	0	0	0	0		379	0 = 0...10V / 0...20 mA
P3.5.2.1.4	AI1 Custom Min	0.0	0.0	0.0	0.0	0.0		380	
P3.5.2.1.5	AI1 Custom Max	100.0	100.0	100.0	100.0	100.0	%	381	
P3.5.2.1.6	AI1 Signal Inversion	0	0	0	0	0		387	
P3.5.2.2.1	AI2 Signal Selection	101	101	101	101	101		388	101 = AnIN SlotA.2
P3.5.2.2.2	AI2 Filter Time	0.1	0.1	0.1	0.1	0.1	s	389	
P3.5.2.2.3	AI2 Signal Range	1	1	1	1	1		390	1 = 2...10V / 4...20 mA
P3.5.2.2.4	AI2 Custom Min	0.0	0.0	0.0	0.0	0.0		391	
P3.5.2.2.5	AI2 Custom Max	100.0	100.0	100.0	100.0	100.0	%	392	

Table 123: The default values of parameters in the different applications

Index	Parameter	Default					Unit	ID	Description
		A	B	C	D	E			
P3.5.2.2.6	AI2 Signal Inversion	0	0	0	0	0		398	
P3.5.3.2.1	RO1 Function	2	2	2	49	2		11001	2 = Run
P3.5.3.2.4	RO2 Function	3	3	3	50	3		11004	3 = Fault
P3.5.3.2.7	RO3 Function	1	1	1	51	1		11007	1 = Ready
P3.5.4.1.1	AO1 Function	2	2	2	2	2		10050	2 = Output Frequency
P3.5.4.1.2	AO1 Filter Time	1.0	1.0	1.0	1.0	1.0	s	10051	
P3.5.4.1.3	AO1 Min Signal	0	0	0	0	0		10052	
P3.5.4.1.4	AO1 Min Scale	0.0	0.0	0.0	0.0	0.0		10053	
P3.5.4.1.5	AO1 Max Scale	0.0	0.0	0.0	0.0	0.0		10054	
P3.10.1	Automatic Reset	0	0	1	1	1		731	0 = Disabled 1 = Enabled
P3.13.2.5	PID Setpoint Selection	0	0	0	0	102		1047	0 = DigIN Slot0.1 102 = DigIN SlotA.3
P3.13.2.6	PID Setpoint Source 1	-	-	1	1	1		332	1 = Keypad Setpoint 1
P3.13.2.10	PID Setpoint Source 2	-	-	-	-	2		431	2 = Keypad Setpoint 2
P3.13.3.1	PID Feedback Function	-	-	1	1	1		333	1 = Only Source1 in use
P3.13.3.3	PID Feedback Source	-	-	2	2	2		334	2 = AI2
P3.15.1	Multi-Pump Mode	-	-	-	0	2		1785	0= Single drive 1= Multifollower 2= Multimaster
P3.15.2	Number of Pumps	1	1	1	3	3		1001	

Table 123: The default values of parameters in the different applications

Index	Parameter	Default					Unit	ID	Description
		A	B	C	D	E			
P3.15.5	Pump Interlocking	-	-	-	1	1		1032	0 = Disabled 1 = Enabled
P3.15.6	Autochange	-	-	-	1	1		1027	0 = Disabled 1 = Enabled (interval) 2 = Enabled (weekdays)
P3.15.7	Autochanged Pumps	-	-	-	1	1		1028	0 = Auxiliary Pump 1 = All Pumps
P3.15.8	Autochange Interval	-	-	-	48.0	48.0	h	1029	
P3.15.11	Autochange Frequency Limit	-	-	-	25.0	50.0	Hz	1031	
P3.15.12	Autochange Pump Limit	-	-	-	1	3		1030	
P3.15.13	Bandwidth	-	-	-	10.0	10.0	%	1097	
P3.15.14	Bandwidth Delay	-	-	-	10	10	s	1098	
P3.15.15	Constant Production Speed	-	-	-	-	100.0	%	1513	
P3.15.16	Running Pumps Limit	-	-	-	3	3		1187	
P5.7.1	Timeout time	5	5	5	5	5	min	804	
P5.7.2	Default Page	4	4	4	4	4		2318	4 = Multimonitor

VACON®

www.danfoss.com

Vacon Ltd
Member of the Danfoss Group
Runsorintie 7
65380 Vaasa
Finland

Document ID:



DPD01083G

Rev. G

Sales code: DOC-APP100FLOW+DLUK