



Programming Guide

VLT[®] Midi Drive FC 280



Contents

1 Introduction	3
1.1 How to Read This Programming Guide	3
1.2 Definitions	4
1.3 Electrical Wiring - Control Cables	7
2 Safety	10
2.1 Safety Symbols	10
2.2 Qualified Personnel	10
2.3 Safety Precautions	10
3 Programming	12
3.1 Local Control Panel Operation	12
3.1.1 Numeric Local Control Panel (LCP)	12
3.1.2 The Right-key Function on NLCP	13
3.1.3 Quick Menu on NLCP	14
3.1.4 Main Menu on NLCP	16
3.1.5 GLCP Layout	18
3.1.6 Parameter Settings	19
3.1.7 Changing Parameter Settings with GLCP	19
3.1.8 Uploading/Downloading Data to/from the GLCP	19
3.1.9 Restoring Default Settings with LCP	19
3.2 Basic Programming	20
3.2.1 Asynchronous Motor Set-up	20
3.2.2 PM Motor Set-up in VVC ⁺	20
3.2.3 Automatic Motor Adaptation (AMA)	21
4 Parameter Descriptions	23
4.1 Parameters: 0-** Operation and Display	23
4.2 Parameters: 1-** Load and Motor	31
4.3 Parameters: 2-** Brakes	41
4.4 Parameters: 3-** Reference/Ramps	43
4.5 Parameters: 4-** Limits/Warnings	49
4.6 Parameters: 5-** Digital In/Out	52
4.7 Parameters: 6-** Analog In/Out	62
4.8 Parameters: 7-** Controllers	66
4.9 Parameters: 8-** Communications and Options	71
4.10 Parameters: 9-** PROFIdrive	75
4.11 Parameters: 10-** CAN Fieldbus	75
4.12 Parameters: 12-** Ethernet	75
4.13 Parameters: 13-** Smart Logic Control	75

4.14 Parameters: 14-** Special Functions	81
4.15 Parameters: 15-** Drive Information	87
4.16 Parameters: 16-** Data Readouts	89
4.17 Parameters: 18-** Data Readouts 2	93
4.18 Parameters: 21-** Ext. Closed Loop	93
4.19 Parameters: 22-** Application Functions	95
4.20 Parameters: 30-** Special Features	97
4.21 Parameters: 32-** Motion Control Basic Settings	97
4.22 Parameters: 33-** Motion Control Adv. Settings	98
4.23 Parameters: 34-** Motion Control Data Readouts	99
4.24 Parameters: 37-** Application Settings	100
5 Parameter Lists	102
5.1 Introduction	102
5.2 Parameter Lists	105
6 Troubleshooting	122
6.1 Warnings and Alarms	122
6.1.1 Alarms	122
6.1.2 Warnings	122
6.1.3 Warning/Alarm Messages	122
6.1.4 Warning and Alarm Code List	123
Index	132

1 Introduction

1.1 How to Read This Programming Guide

1.1.1 Purpose of the Manual

This programming guide provides information about controlling the frequency converter, accessing parameters, programming, and troubleshooting.

The programming guide is intended for use by qualified personnel who are familiar with the VLT® Midi Drive FC 280 frequency converter.

Read the instructions before programming and follow the procedures in this manual.

VLT® is a registered trademark.

1.1.2 Additional Resources

Additional resources include:

- *VLT® Midi Drive FC 280 Operating Guide*, provides the necessary information for getting the frequency converter up and running.
- *VLT® Midi Drive FC 280 Design Guide*, provides detailed technical information about the frequency converter, customer design, and applications.

Contact the local Danfoss supplier or go to drives.danfoss.com/knowledge-center/technical-documentation/ to download the documentations.

1.1.3 Document and Software Version

This manual is regularly reviewed and updated. All suggestions for improvement are welcome. *Table 1.1* shows the document version and the corresponding software version.

Edition	Remarks	Software version
MG07C3	Update due to new software version release.	1.2

Table 1.1 Document and Software Version

°C	Degrees Celsius
°F	Fahrenheit
AC	Alternating current
AEO	Automatic energy optimization
ACP	Application control processor
AWG	American wire gauge
AMA	Automatic motor adaptation
DC	Direct current
EEPROM	Electrically erasable programmable read-only memory
EMC	Electromagnetic compatibility
EMI	Electromagnetic interference
ESD	Electrostatic discharge
ETR	Electronic thermal relay
f _{M,N}	Nominal motor frequency
FC	Frequency converter
IGBT	Insulated-gate bipolar transistor
IP	Ingress protection
I _{LIM}	Current limit
I _{INV}	Rated inverter output current
I _{M,N}	Nominal motor current
I _{VLT,MAX}	Maximum output current
I _{VLT,N}	Rated output current supplied by the frequency converter
L _d	Motor d-axis inductance
L _q	Motor q-axis inductance
LCP	Local control panel
LED	Light-emitting diode
MCP	Motor control processor
N.A.	Not applicable
NEMA	National Electrical Manufacturers Association
P _{M,N}	Nominal motor power
PCB	Printed circuit board
PE	Protective earth
PELV	Protective extra low voltage
PWM	Pulse-width modulation
R _s	Stator resistance
Regen	Regenerative terminals
RPM	Revolutions per minute
RFI	Radio frequency interference
SCR	Silicon controlled rectifier
SMPS	Switch mode power supply
T _{LIM}	Torque limit
U _{M,N}	Nominal motor voltage
X _h	Motor main reactance

Table 1.2 Abbreviations

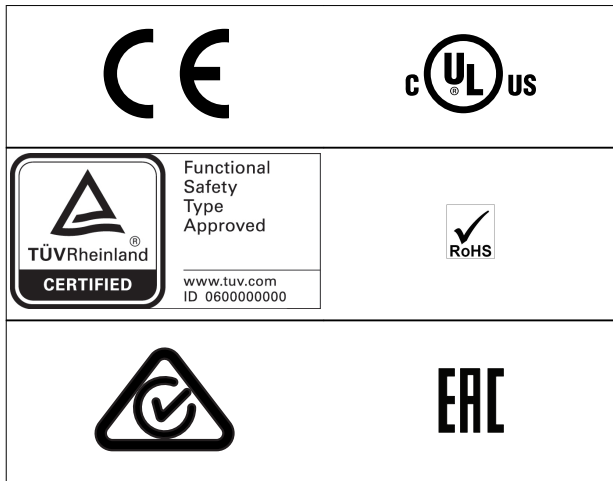

For compliance with the European Agreement concerning International Carriage of Dangerous Goods by Inland Waterways (ADN), refer to *chapter ADN-compliant Installation* in the *VLT® Midi Drive FC 280 Design Guide*.

The frequency converter complies with UL 508C thermal memory retention requirements. For more information, refer to *chapter Motor Thermal Protection* in the *VLT® Midi Drive FC 280 Design Guide*.

Applied standards and compliance for STO

Using STO on terminals 37 and 38 requires fulfillment of all provisions for safety including relevant laws, regulations, and guidelines. The integrated STO function complies with the following standards:

- IEC/EN 61508: 2010 SIL2
- IEC/EN 61800-5-2: 2007 SIL2
- IEC/EN 62061: 2012 SILCL of SIL2
- IEC/EN 61326-3-1: 2008
- EN ISO 13849-1: 2008 Category 3 PL d

1.2 Definitions

1.2.1 Frequency Converter

Coast

The motor shaft is in free mode. No torque on the motor.

$I_{VLT,MAX}$

Maximum output current.

$I_{VLT,N}$

Rated output current supplied by the frequency converter.

$U_{VLT,MAX}$

Maximum output voltage.

1.2.2 Input

Control commands

Start and stop the connected motor with LCP and digital inputs.

Functions are divided into 2 groups.

Functions in group 1 have higher priority than functions in group 2.

Group 1	Precise stop, coast stop, precise stop and coast stop, quick stop, DC braking, stop, and [OFF].
Group 2	Start, pulse start, reversing, start reversing, jog, and freeze output.

Table 1.3 Function Groups

1.2.3 Motor

Motor running

Torque generated on the output shaft and speed from 0 RPM to maximum speed on the motor.

f_{JOG}

Motor frequency when the jog function is activated (via digital terminals).

f_M

Motor frequency.

f_{MAX}

Maximum motor frequency.

f_{MIN}

Minimum motor frequency.

$f_{M,N}$

Rated motor frequency (nameplate data).

I_M

Motor current (actual).

$I_{M,N}$

Nominal motor current (nameplate data).

$n_{M,N}$

Nominal motor speed (nameplate data).

n_s

Synchronous motor speed.

$$n_s = \frac{2 \times \text{Parameter 1-23} \times 60 \text{ s}}{\text{Parameter 1-39}}$$

n_{slip}

Motor slip.

$P_{M,N}$

Rated motor power (nameplate data in kW or hp).

$T_{M,N}$

Rated torque (motor).

U_M

Instantaneous motor voltage.

$U_{M,N}$

Rated motor voltage (nameplate data).

Break-away torque

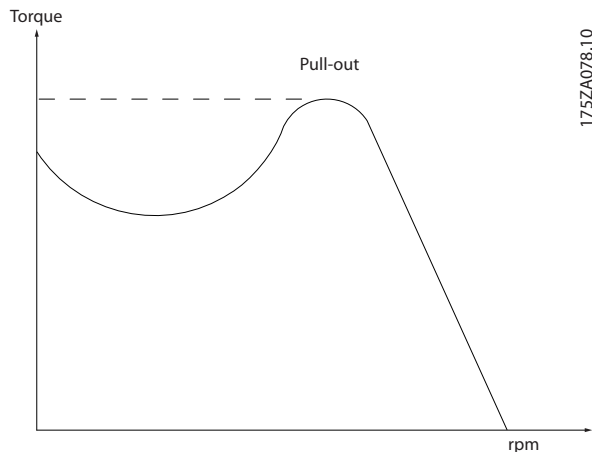

Illustration 1.1 Break-away Torque

η_{VLT}

The efficiency of the frequency converter is defined as the ratio between the power output and the power input.

Start-disable command

A start-disable command belonging to the control commands in group 1. See *Table 1.3* for more details.

Stop command

A stop command belonging to the control commands in group 1. See *Table 1.3* for more details.

1.2.4 References

Analog reference

A signal transmitted to the analog inputs 53 or 54 can be voltage or current.

Binary reference

A signal transmitted to the serial communication port.

Preset reference

A defined preset reference to be set from -100% to +100% of the reference range. Selection of 8 preset references via the digital terminals.

Pulse reference

A pulse frequency signal transmitted to the digital inputs (terminal 29 or 33).

Ref_{MAX}

Determines the relationship between the reference input at 100% full scale value (typically 10 V, 20 mA) and the resulting reference. The maximum reference value is set in *parameter 3-03 Maximum Reference*.

Ref_{MIN}

Determines the relationship between the reference input at 0% value (typically 0 V, 0 mA, 4 mA) and the resulting reference. The minimum reference value is set in *parameter 3-02 Minimum Reference*.

1.2.5 Miscellaneous

Analog inputs

The analog inputs are used for controlling various functions of the frequency converter.

There are 2 types of analog inputs:

- Current input, 0–20 mA and 4–20 mA.
- Voltage input, 0 to +10 V DC.

Analog outputs

The analog outputs can supply a signal of 0–20 mA, or 4–20 mA.

Automatic motor adaptation, AMA

The AMA algorithm determines the electrical parameters for the connected motor at standstill.

Brake resistor

The brake resistor is a module capable of absorbing the brake power generated in regenerative braking. This regenerative brake power increases the intermediate circuit voltage, and a brake chopper ensures that the power is transmitted to the brake resistor.

CT characteristics

Constant torque characteristics used for all applications such as conveyor belts, displacement pumps, and cranes.

Digital inputs

The digital inputs can be used for controlling various functions of the frequency converter.

Digital outputs

The frequency converter features 2 solid-state outputs that can supply a 24 V DC (maximum 40 mA) signal.

DSP

Digital signal processor.

ETR

Electronic thermal relay is a thermal load calculation based on present load and time. Its purpose is to estimate the motor temperature.

FC standard bus

Includes RS485 bus with FC protocol or MC protocol. See *parameter 8-30 Protocol*.

Initializing

If initializing is carried out (*parameter 14-22 Operation Mode*), the frequency converter returns to the default setting.

Intermittent duty cycle

An intermittent duty rating refers to a sequence of duty cycles. Each cycle consists of an on-load and an off-load period. The operation can be either periodic duty or non-periodic duty.

LCP

The local control panel makes up a complete interface for control and programming of the frequency converter. The control panel is detachable and can be installed up to 3 m

(9.8 ft) from the frequency converter, that is, in a front panel with the installation kit option.

NLCP

The numerical local control panel interface for control and programming of the frequency converter. The display is numerical and the panel is used to show process values. The NLCP has storing and copy functions.

lsb

Least significant bit.

msb

Most significant bit.

MCM

Short for mille circular mil, an American measuring unit for cable cross-section. 1 MCM = 0.5067 mm².

On-line/off-line parameters

Changes to on-line parameters are activated immediately after the data value is changed. Press [OK] to activate changes to off-line parameters.

Process PID

The PID control maintains speed, pressure, and temperature by adjusting the output frequency to match the varying load.

PCD

Process control data.

Power cycle

Switch off the mains until the display (LCP) is dark, then turn power on again.

Power factor

The power factor is the relation between I_1 and I_{RMS} .

$$\text{Power factor} = \frac{\sqrt{3} \times U \times I_1 \cos\phi_1}{\sqrt{3} \times U \times I_{RMS}}$$

$\cos\phi_1 = 1$, therefore:

$$\text{Power factor} = \frac{I_1 \times \cos\phi_1}{I_{RMS}} = \frac{I_1}{I_{RMS}}$$

The power factor indicates to which extent the frequency converter imposes a load on the mains supply.

The lower the power factor, the higher the I_{RMS} for the same kW performance.

$$I_{RMS} = \sqrt{I_1^2 + I_5^2 + I_7^2 + \dots + I_n^2}$$

In addition, a high power factor indicates that the different harmonic currents are low.

The built-in DC coils produce a high power factor, minimizing the imposed load on the mains supply.

Pulse input/incremental encoder

An external, digital pulse transmitter used for feeding back information on motor speed. The encoder is used in applications where great accuracy in speed control is required.

RCD

Residual current device.

Set-up

Save parameter settings in 4 set-ups. Change among the 4 parameter set-ups and edit 1 set-up while this set-up is inactive.

SFAVM

Acronym describing the switching pattern stator flux-oriented asynchronous vector modulation.

Slip compensation

The frequency converter compensates for the motor slip by giving the frequency a supplement that follows the measured motor load, keeping the motor speed almost constant.

Smart logic control (SLC)

The SLC is a sequence of user-defined actions executed when the associated user-defined events are evaluated as true by the smart logic controller (*parameter group 13-** Smart Logic Control*).

STW

Status word.

THD

Total harmonic distortion states the total contribution of harmonic distortion.

Thermistor

A temperature-dependent resistor placed where the temperature is monitored (frequency converter or motor).

Trip

A state entered in fault situations, for example, if the frequency converter is subject to overvoltage or when it is protecting the motor, process, or mechanism. Restart is prevented until the cause of the fault has disappeared, and the trip state is canceled by activating reset or, sometimes, by being programmed to reset automatically. Do not use trip for personal safety.

Trip lock

A state entered in fault situations when the frequency converter is protecting itself and requiring physical intervention, for example, if the frequency converter is subject to a short circuit on the output. A locked trip can only be canceled by cutting off mains, removing the cause of the fault, and reconnecting the frequency converter. Restart is prevented until the trip state is canceled by activating reset or, in some cases, by being programmed to reset automatically. Do not use trip lock for personal safety.

VT characteristics

Variable torque characteristics used for pumps and fans.

VVC+

If compared with standard voltage/frequency ratio control, voltage vector control (VVC+) improves the dynamics and stability, both when the speed reference is changed and in relation to the load torque.

60° AVM

Refers to the switching pattern 60° asynchronous vector modulation.

1.3 Electrical Wiring - Control Cables

1.3.1 Overview

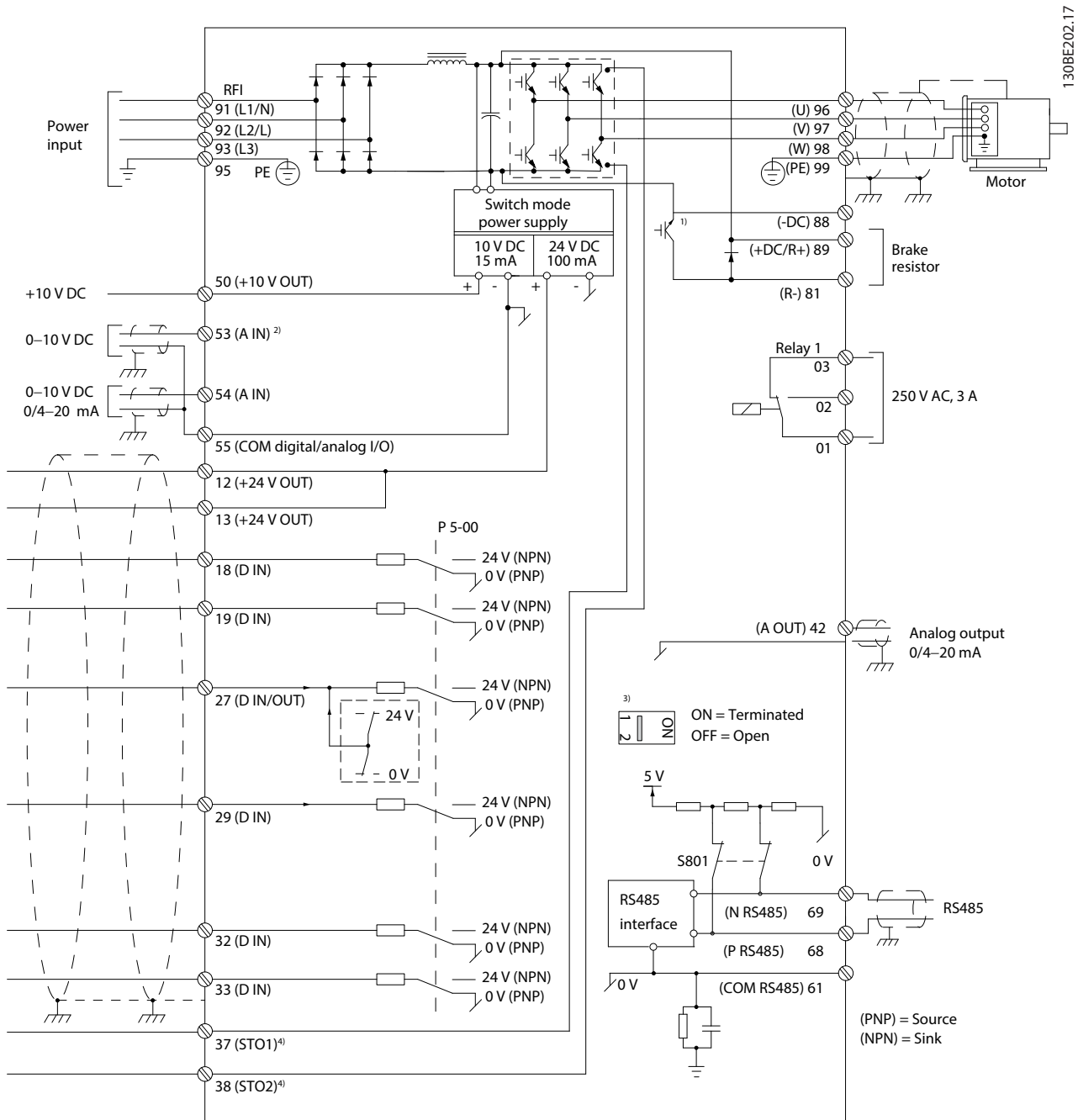

Illustration 1.2 Basic Wiring Schematic Drawing

A=Analog, D=Digital

1) Built-in brake chopper is only available on 3-phase units.

2) Terminal 53 can also be used as digital input.

3) Switch S801 (bus terminal) can be used to enable termination on the RS485 port (terminals 68 and 69).

4) Refer to chapter 6 Safe Torque Off (STO) in the operating guide for the correct STO wiring.

In rare cases, long control cables and analog signals result in 50/60 Hz ground loops due to noise from mains supply cables. If this occurs, break the shield or insert a 100 nF capacitor between shield and chassis.

Connect the digital and analog inputs and outputs separately to the common inputs (terminal 55) of the frequency converter to avoid that ground currents from both groups affect other groups. For example, switching on the digital input could disturb the analog input signal.

Input polarity of control terminals

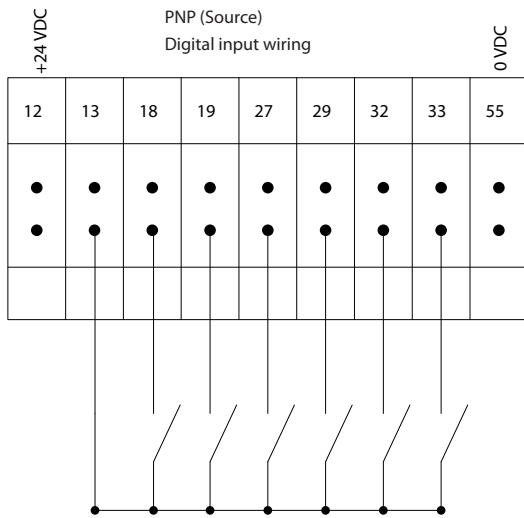

Illustration 1.3 PNP (Source)

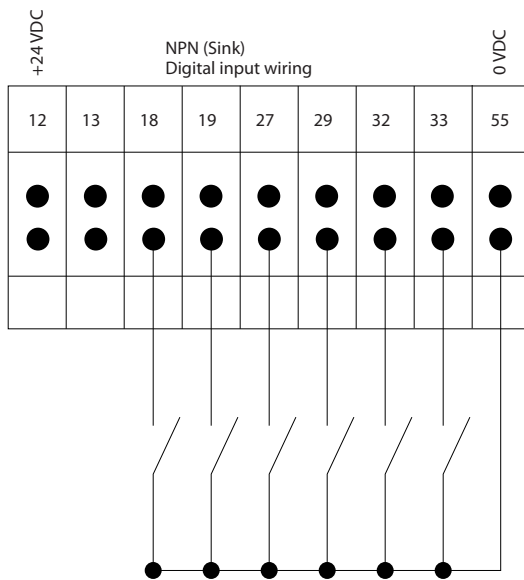

Illustration 1.4 NPN (Sink)

NOTICE

Control cables must be shielded/armored.

See the section *Using Shielded Control Cables* in the *design guide* for the correct termination of control cables.

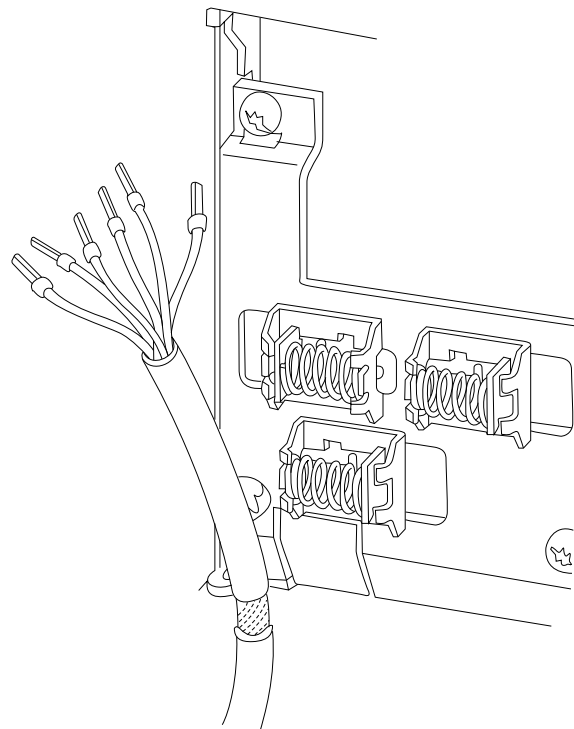

Illustration 1.5 Grounding of Shielded/Armored Control Cables

1.3.2 Start/Stop

Terminal 18 = Parameter 5-10 Terminal 18 Digital Input [8] Start.

Terminal 27 = Parameter 5-12 Terminal 27 Digital Input [0] No operation (Default coast inverse).

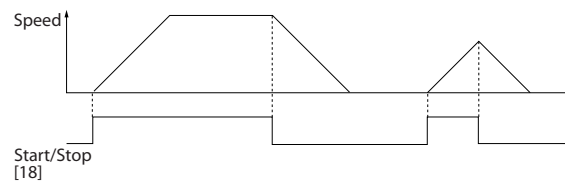
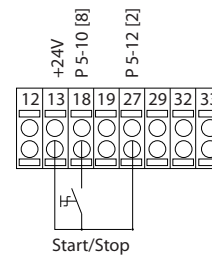

Illustration 1.6 Start/Stop

1.3.3 Pulse Start/Stop

Terminal 18 = Parameter 5-10 Terminal 18 Digital Input [9] Latched start.
 Terminal 27 = Parameter 5-12 Terminal 27 Digital Input [6] Stop inverse.

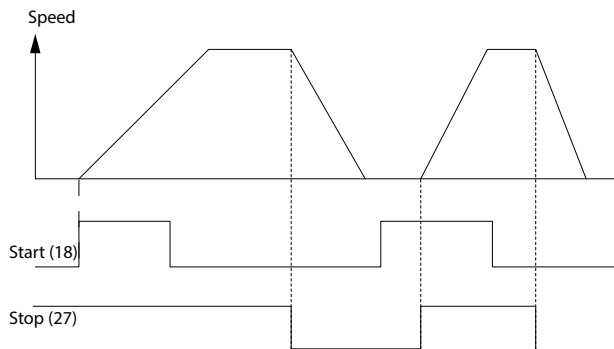
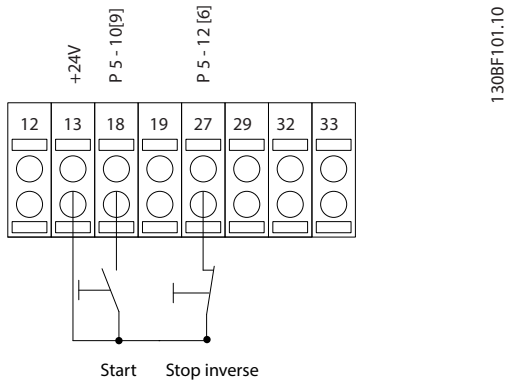

Illustration 1.7 Pulse Start/Stop

1.3.4 Speed Up/Down

Terminals 29/32 = Speed up/down

Terminal 18 = Parameter 5-10 Terminal 18 Digital Input [9] Start (default).
 Terminal 27 = Parameter 5-12 Terminal 27 Digital Input [19] Freeze reference.
 Terminal 29 = Parameter 5-13 Terminal 29 Digital Input [21] Speed up.
 Terminal 32 = Parameter 5-14 Terminal 32 Digital Input [22] Speed down.

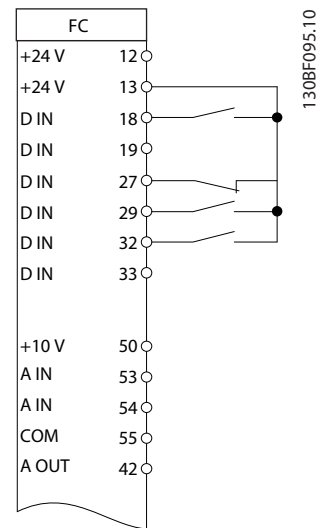

Illustration 1.8 Speed Up/Down

1.3.5 Potentiometer Reference

Voltage reference via a potentiometer

Reference source 1 = [1] Analog input 53 (default).
 Terminal 53, low voltage = 0 V.
 Terminal 53, high voltage = 10 V.
 Terminal 53, low ref./feedback = 0 Hz.
 Terminal 53, high ref./feedback = 50 Hz.
 Parameter 6-19 Terminal 53 mode = [1] Voltage.

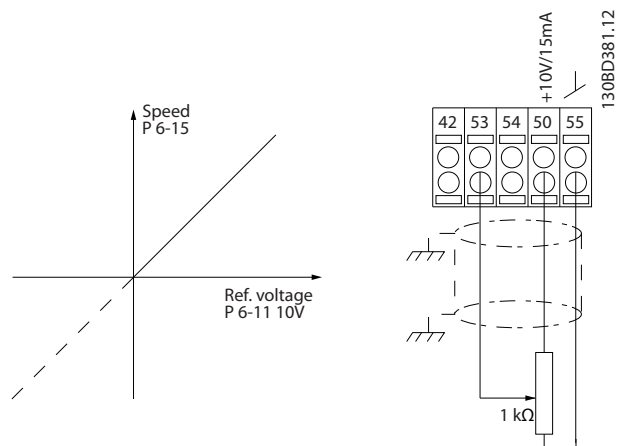

Illustration 1.9 Potentiometer Reference

2

2 Safety

2.1 Safety Symbols

The following symbols are used in this document:

⚠ WARNING

Indicates a potentially hazardous situation that could result in death or serious injury.

⚠ CAUTION

Indicates a potentially hazardous situation that could result in minor or moderate injury. It can also be used to alert against unsafe practices.

NOTICE

Indicates important information, including situations that can result in damage to equipment or property.

2.2 Qualified Personnel

Correct and reliable transport, storage, installation, operation, and maintenance are required for the trouble-free and safe operation of the frequency converter. Only qualified personnel are allowed to install or operate this equipment.

Qualified personnel are defined as trained staff, who are authorized to install, commission, and maintain equipment, systems, and circuits in accordance with pertinent laws and regulations. Also, the personnel must be familiar with the instructions and safety measures described in this guide.

2.3 Safety Precautions

⚠ WARNING

HIGH VOLTAGE

Frequency converters contain high voltage when connected to AC mains input, DC supply, or load sharing. Failure to perform installation, start-up, and maintenance by qualified personnel can result in death or serious injury.

- Only qualified personnel must perform installation, start-up, and maintenance.

⚠ WARNING

UNINTENDED START

When the frequency converter is connected to AC mains, DC supply, or load sharing, the motor may start at any time. Unintended start during programming, service, or repair work can result in death, serious injury, or property damage. The motor can start with an external switch, a fieldbus command, an input reference signal from the LCP, via remote operation using MCT 10 Set-up Software, or after a cleared fault condition.

To prevent unintended motor start:

- Disconnect the frequency converter from the mains.
- Press [Off/Reset] on the LCP before programming parameters.
- Completely wire and assemble the frequency converter, motor, and any driven equipment before connecting the frequency converter to AC mains, DC supply, or load sharing.

⚠ WARNING

DISCHARGE TIME

The frequency converter contains DC-link capacitors, which can remain charged even when the frequency converter is not powered. High voltage can be present even when the warning LED indicator lights are off. Failure to wait the specified time after power has been removed before performing service or repair work can result in death or serious injury.

- Stop the motor.
- Disconnect AC mains and remote DC-link supplies, including battery back-ups, UPS, and DC-link connections to other frequency converters.
- Disconnect or lock PM motor.
- Wait for the capacitors to discharge fully. The minimum waiting time is specified in *Table 2.1*.
- Before performing any service or repair work, use an appropriate voltage measuring device to make sure that the capacitors are fully discharged.

Voltage [V]	Power range [kW (hp)]	Minimum waiting time (minutes)
200–240	0.37–3.7 (0.5–5)	4
380–480	0.37–7.5 (0.5–10)	4
	11–22 (15–30)	15

Table 2.1 Discharge Time

⚠ WARNING**LEAKAGE CURRENT HAZARD**

Leakage currents exceed 3.5 mA. Failure to ground the frequency converter properly can result in death or serious injury.

- Ensure the correct grounding of the equipment by a certified electrical installer.

⚠ WARNING**EQUIPMENT HAZARD**

Contact with rotating shafts and electrical equipment can result in death or serious injury.

- Ensure that only trained and qualified personnel perform installation, start-up, and maintenance.
- Ensure that electrical work conforms to national and local electrical codes.
- Follow the procedures in this guide.

⚠ CAUTION**INTERNAL FAILURE HAZARD**

An internal failure in the frequency converter can result in serious injury when the frequency converter is not properly closed.

- Ensure that all safety covers are in place and securely fastened before applying power.

3 Programming

3

3.1 Local Control Panel Operation

The frequency converter supports numerical local control panel (NLCP), graphic local control panel (GLCP), and blind cover. This section describes the operations with NLCP and GLCP.

NOTICE

The frequency converter can also be programmed from the MCT 10 Set-up Software on PC via RS485 communication port or USB port. This software can be ordered using ordering number 130B1000 or downloaded from the Danfoss website: www.danfoss.com/BusinessAreas/DrivesSolutions/softwaredownload.

3.1.1 Numeric Local Control Panel (LCP)

The numerical local control panel (NLCP) is divided into 4 functional sections.

- A. Numeric display.
- B. Menu key.
- C. Navigation keys and indicator lights (LEDs).
- D. Operation keys and indicator lights (LEDs).

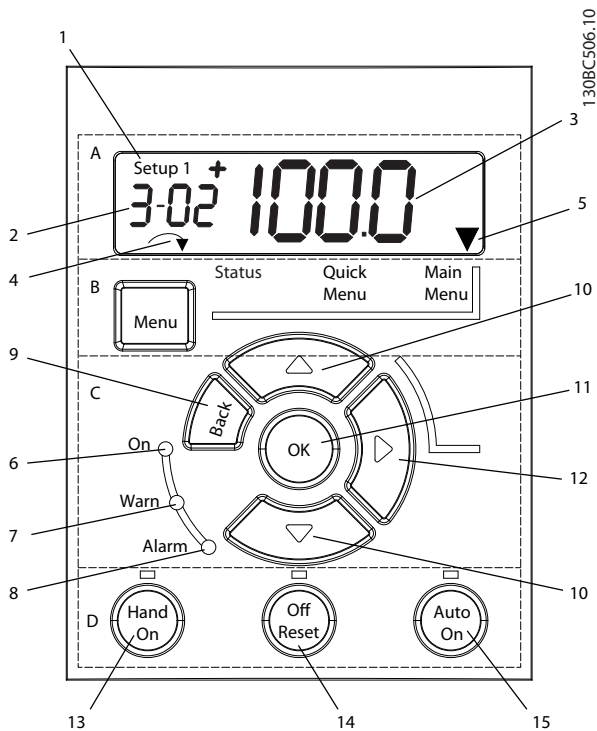

Illustration 3.1 View of the NLCP

A. Numeric display

The LCD display is backlit with 1 numeric line. All data is shown in the NLCP.

1	The set-up number shows the active set-up and the edit set-up. If the same set-up acts as both active and edit set-up, only that set-up number is shown (factory setting). When active and edit set-up differ, both numbers are shown in the display (for example set-up 12). The number flashing indicates the edit set-up.
2	Parameter number.
3	Parameter value.
4	Motor direction is shown at the bottom left of the display. A small arrow indicates the direction.
5	The triangle indicates whether the LCP is in Status, Quick Menu, or Main Menu.

Table 3.1 Legend to Illustration 3.1, Section A



Illustration 3.2 Display Information

B. Menu key

To select between Status, Quick Menu, or Main Menu, press [Menu].

C. Indicator lights (LEDs) and navigation keys

	Indicator	Light	Function
6	On	Green	ON turns on when the frequency converter receives power from the mains voltage, a DC bus terminal, or a 24 V external supply.
7	Warn	Yellow	When warning conditions are met, the yellow WARN LED turns on, and text appears in the display area identifying the problem.
8	Alarm	Red	A fault condition causes the red alarm LED to flash and an alarm text is shown.

Table 3.2 Legend to Illustration 3.1, Indicator Lights (LEDs)

	Key	Function
9	[Back]	For moving to the previous step or layer in the navigation structure.
10	[▲] [▼]	For switching between parameter groups, parameters, and within parameters, or increasing/decreasing parameter values. Arrows can also be used for setting local reference.
11	[OK]	Press to access parameter groups or to enable a selection.
12	[▶]	Press to move from left to right within the parameter value to change each digit individually.

Table 3.3 Legend to *Illustration 3.1*, Navigation Keys

D. Operation keys and indicator lights (LEDs)

	Key	Function
13	Hand On	Starts the frequency converter in local control. <ul style="list-style-type: none"> An external stop signal by control input or serial communication overrides the local hand on.
14	Off/Reset	Stops the motor but does not remove power to the frequency converter or resets the frequency converter manually after a fault has been cleared.
15	Auto On	Puts the system in remote operational mode. <ul style="list-style-type: none"> Responds to an external start command by control terminals or serial communication.

Table 3.4 Legend to *Illustration 3.1*, Section D

⚠ WARNING

ELECTRICAL HAZARD

Even after pressing the [Off/Reset] key, voltage is present at the terminals of the frequency converter. Pressing the [Off/Reset] key does not disconnect the frequency converter from mains. Touching live parts can result in death or serious injury.

- Do not touch any live parts.

3.1.2 The Right-key Function on NLCP

Press [▶] to edit any of the 4 digits on the display individually. When pressing [▶] once, the cursor moves to the first digit, and the digit starts flashing as shown in *Illustration 3.3*. Press the [▲] [▼] to change the value. Pressing [▶] does not change the value of the digits, or move the decimal point.

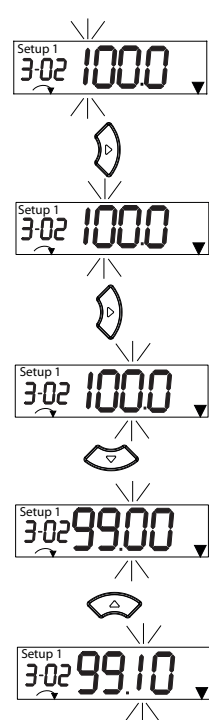

Illustration 3.3 Right-key Function

[▶] can also be used for moving between parameter groups. When in Main Menu, press [▶] to move to the first parameter in the next parameter group (for example, move from *parameter 0-03 Regional Settings [0] International* to *parameter 1-00 Configuration Mode [0] Open loop*).

NOTICE

During start-up, the NLCP shows the message *LCP ON*. When this message is no longer shown, the frequency converter is ready for operation. Adding or removing options can extend the duration of start-up.

3.1.3 Quick Menu on NLCP

The *Quick Menu* gives easy access to the most frequently used parameters.

3

1. To enter *Quick Menu*, press [Menu] until the indicator in the display is placed above *Quick Menu*.
2. Press [▲] [▼] to select either QM1 or QM2, then press [OK].
3. Press [▲] [▼] to browse through the parameters in *Quick Menu*.
4. Press [OK] to select a parameter.
5. Press [▲] [▼] to change the value of a parameter setting.
6. Press [OK] to accept the change.
7. To exit, press either [Back] twice (or 3 times if in QM2 and QM3) to enter *Status*, or press [Menu] once to enter *Main Menu*.

130BC445.12

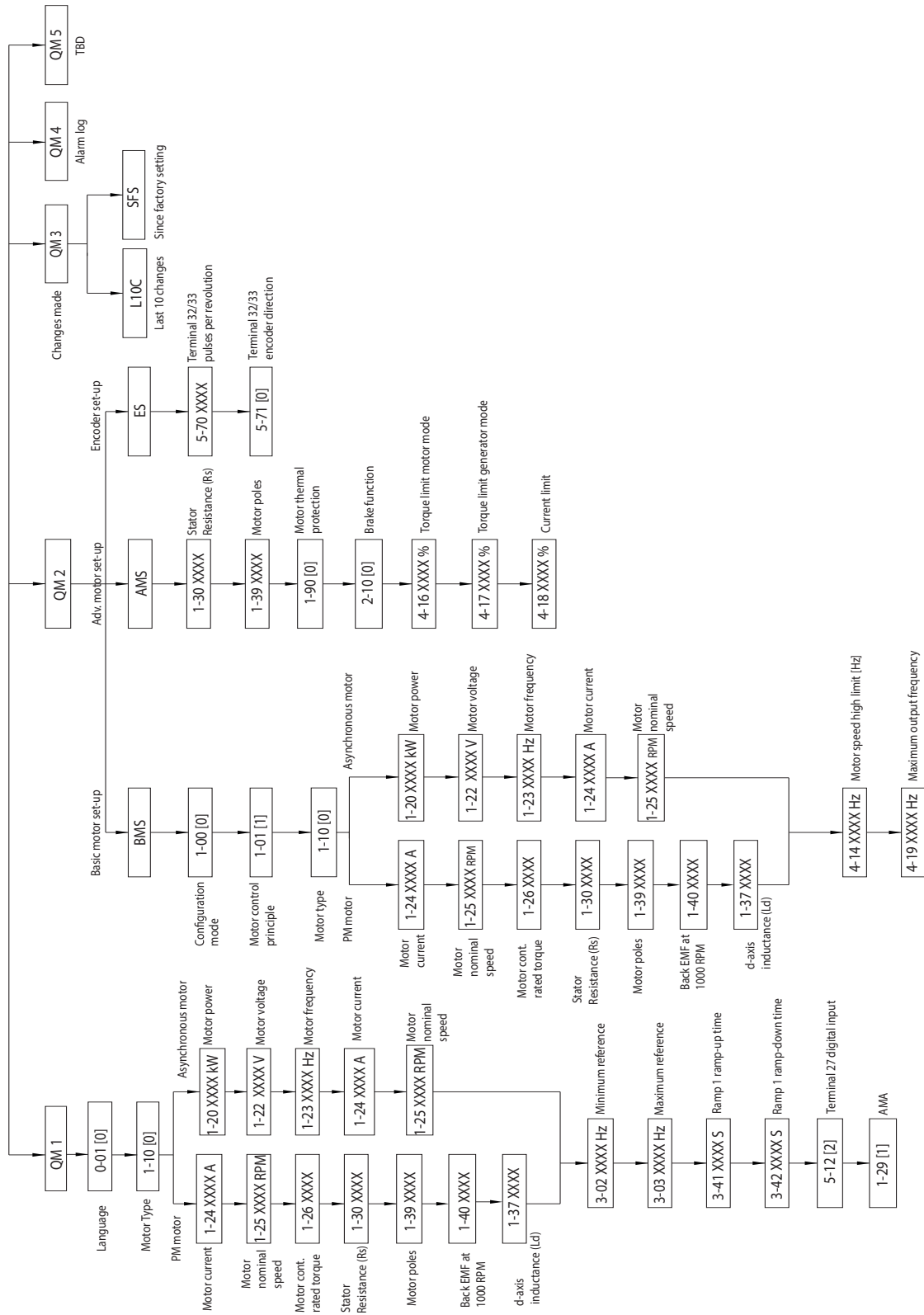

Illustration 3.4 Quick Menu Structure

3.1.4 Main Menu on NLCP

The *Main Menu* gives access to all parameters.

3

1. To enter *Main Menu*, press [Menu] until the indicator in the display is placed above *Main Menu*.
2. [▲] [▼]: Browse through the parameter groups.
3. Press [OK] to select a parameter group.
4. [▲] [▼]: Browse through the parameters in the specific group.
5. Press [OK] to select the parameter.
6. [▶] and [▲] [▼]: Set/change the parameter value.
7. Press [OK] to accept the value.
8. To exit, press either [Back] twice (or 3 times for array parameters) to enter *Main Menu*, or press [Menu] once to enter *Status*.

See *Illustration 3.5*, *Illustration 3.6*, and *Illustration 3.7* for the principles of changing the value of continuous, enumerated, and array parameters, respectively. The actions in the illustrations are described in *Table 3.5*, *Table 3.6*, and *Table 3.7*.

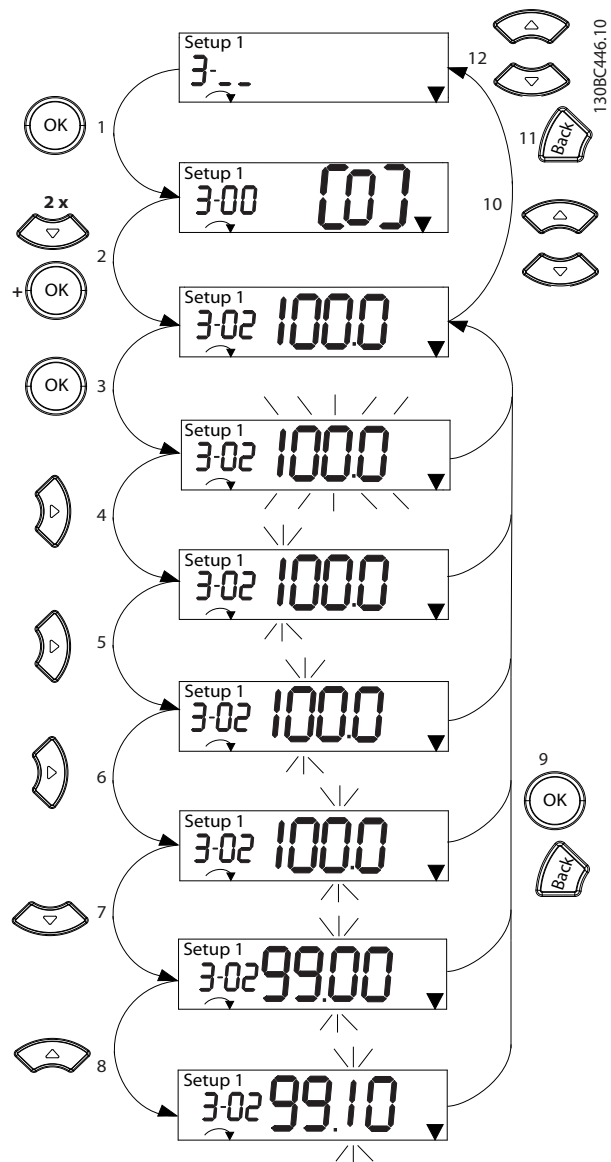

Illustration 3.5 Main Menu Interactions - Continuous Parameters

1	[OK]: The first parameter in the group is shown.
2	Press [▼] repeatedly to move down to the parameter.
3	Press [OK] to start editing.
4	[▶]: First digit flashing (can be edited).
5	[▶]: Second digit flashing (can be edited).
6	[▶]: Third digit flashing (can be edited).
7	[▼]: Decrease the parameter value, the decimal point changes automatically.
8	[▲]: Increase the parameter value.
9	[Back]: Cancel changes, return to 2. [OK]: Accept changes, return to 2.
10	[▲][▼]: Select parameter within the group.
11	[Back]: Remove the value and show the parameter group.
12	[▲][▼]: Select group.

Table 3.5 Changing Values in Continuous Parameters

For enumerated parameters, the interaction is similar, but the parameter value is shown in brackets because of the digits limitation (4 large digits) on the NLCP, and the enum can be greater than 99. When the enum value is greater than 99, the LCP can only show the first part of the bracket.

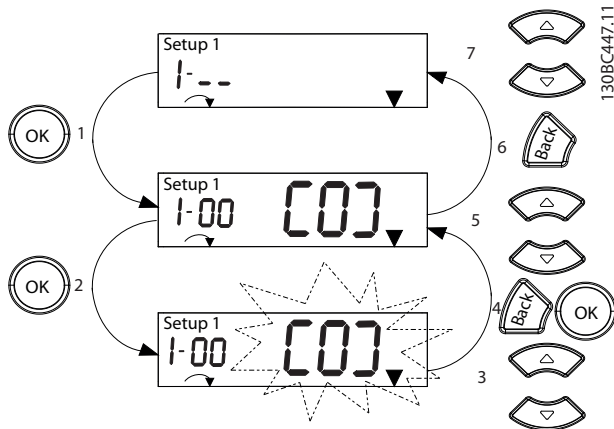

Illustration 3.6 Main Menu Interactions - Enumerated Parameters

1	[OK]: The first parameter in the group is shown.
2	Press [OK] to start editing.
3	[▲][▼]: Change parameter value (flashing).
4	Press [Back] to cancel changes or [OK] to accept changes (return to screen 2).
5	[▲][▼]: Select a parameter within the group.
6	[Back]: Remove the value and show the parameter group.
7	[▲][▼]: Select a group.

Table 3.6 Changing Values in Enumerated Parameters

Array parameters function as follows:

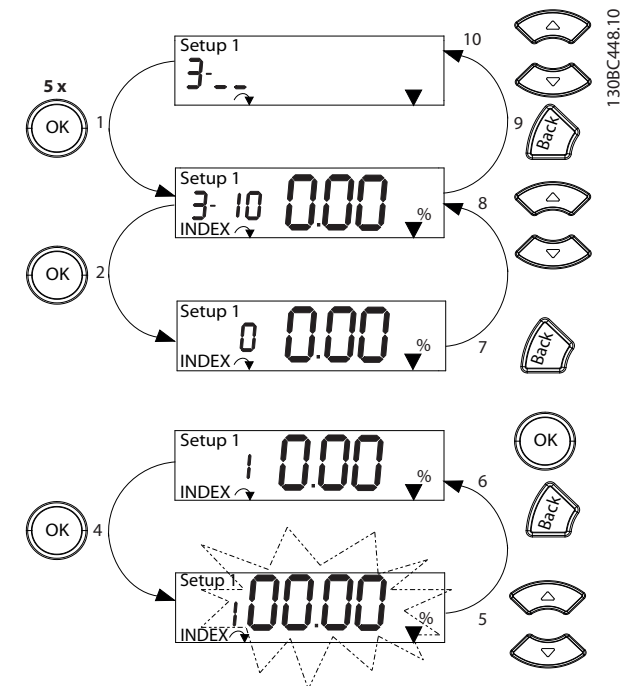

Illustration 3.7 Main Menu Interactions - Array Parameters

1	[OK]: Show parameter numbers and the value in the first index.
2	[OK]: Index can be selected.
3	[▲][▼]: Select index.
4	[OK]: Value can be edited.
5	[▲][▼]: Change parameter value (flashing).
6	[Back]: Cancel changes. [OK]: Accept changes.
7	[Back]: Cancel editing index, select a new parameter.
8	[▲][▼]: Select parameter within the group.
9	[Back]: Remove parameter index value and show the parameter group.
10	[▲][▼]: Select group.

Table 3.7 Changing Values in Array Parameters

3.1.5 GLCP Layout

The GLCP is divided into 4 functional groups (see *Illustration 3.8*).

3

- A. Display area
- B. Display menu keys
- C. Navigation keys and indicator lights (LEDs)
- D. Operation keys and reset

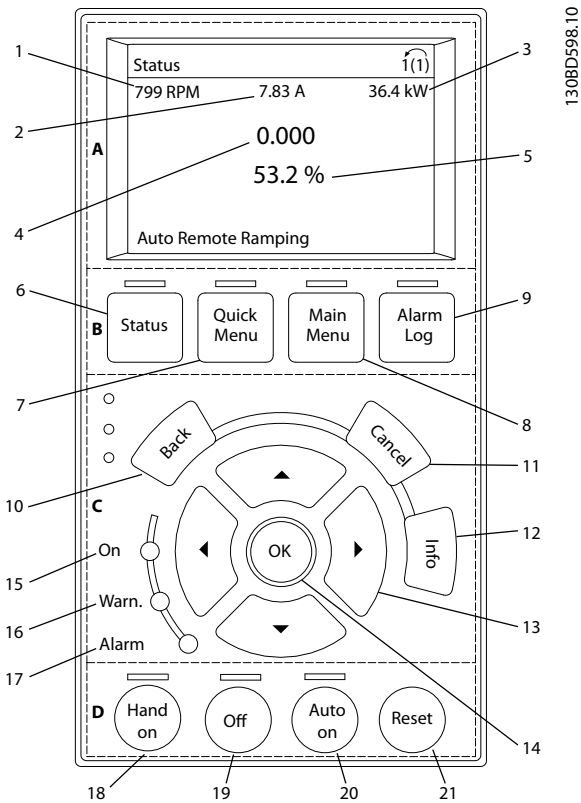

Illustration 3.8 Graphic Local Control Panel (GLCP)

A. Display area

The display area is activated when the frequency converter receives power from the mains voltage, a DC bus terminal, or a 24 V DC external supply.

The information shown on the LCP can be customized for user applications. Select options in the *Quick Menu Q3-13 Display Settings*.

Display	Parameter number	Default setting
1	0-20	[1602] Reference [%]
2	0-21	[1614] Motor Current
3	0-22	[1610] Power [kW]
4	0-23	[1613] Frequency
5	0-24	[1502] kWh Counter

Table 3.8 Legend to *Illustration 3.8*, Display Area

B. Display menu keys

Menu keys are used for menu access for parameter set-up, toggling through status display modes during normal operation, and viewing fault log data.

	Key	Function
6	Status	Shows operational information.
7	Quick Menu	Allows access to programming parameters for initial set-up instructions and many detailed application instructions.
8	Main Menu	Allows access to all programming parameters.
9	Alarm Log	Shows a list of current warnings, the last 10 alarms, and the maintenance log.

Table 3.9 Legend to *Illustration 3.8*, Display Menu Keys

C. Navigation keys and indicator lights (LEDs)

Navigation keys are used for programming functions and moving the display cursor. The navigation keys also provide speed control in local operation. There are also 3 frequency converter status indicator lights in this area.

	Key	Function
10	Back	Reverts to the previous step or list in the menu structure.
11	Cancel	Cancels the last change or command as long as the display mode has not changed.
12	Info	Press for a definition of the function being shown.
13	Navigation keys	To move between items in the menu, use the 4 navigation keys.
14	OK	Press to access parameter groups or to enable a selection.

Table 3.10 Legend to *Illustration 3.8*, Navigation Keys

	Indicator	Light	Function
15	On	Green	ON turns on when the frequency converter receives power from the mains voltage, a DC bus terminal, or a 24 V external supply.
16	Warn	Yellow	When warning conditions are met, the yellow WARN LED turns on, and text appears in the display area identifying the problem.
17	Alarm	Red	A fault condition causes the red alarm LED to flash, and an alarm text is shown.

Table 3.11 Legend to *Illustration 3.8*, Indicator Lights (LEDs)

D. Operation keys and reset

Operation keys are at the bottom of the LCP.

	Key	Function
18	Hand On	Starts the frequency converter in hand-on mode. <ul style="list-style-type: none"> An external stop signal by control input or serial communication overrides the local hand on.
19	Off	Stops the motor but does not remove power to the frequency converter.
20	Auto On	Puts the system in remote operational mode. <ul style="list-style-type: none"> Responds to an external start command by control terminals or serial communication.
21	Reset	Resets the frequency converter manually after a fault has been cleared.

Table 3.12 Legend to *Illustration 3.8, Operation Keys and Reset*

NOTICE

To adjust the display contrast, press [Status] and the [▲]/[▼] keys.

3.1.6 Parameter Settings

Establishing the correct programming for applications often requires setting functions in several related parameters. Details for parameters are provided in *chapter 4 Parameter Descriptions*.

Programming data is stored internally in the frequency converter.

- For back-up, upload data into the LCP memory.
- To download data to another frequency converter, connect the LCP to that unit and download the stored settings.
- Restoring factory default settings does not change data stored in the LCP memory.

3.1.7 Changing Parameter Settings with GLCP

Access and change parameter settings from the *Quick Menu* or from the *Main Menu*. The *Quick Menu* only gives access to a limited number of parameters.

- Press [Quick Menu] or [Main Menu] on the LCP.
- Press [▲] [▼] to browse through the parameter groups, press [OK] to select a parameter group.
- Press [▲] [▼] to browse through the parameters, press [OK] to select a parameter.

- Press [▲] [▼] to change the value of a parameter setting.
- Press [◀] [▶] to shift digit when a decimal parameter is in the editing state.
- Press [OK] to accept the change.
- Press either [Back] twice to enter Status, or press [Main Menu] once to enter the Main Menu.

View changes

Quick Menu Q5 - Changes Made lists all parameters changed from default settings.

- The list only shows parameters, which have been changed in the current edit set-up.
- Parameters which have been reset to default values are not listed.
- The message *Empty* indicates that no parameters have been changed.

3.1.8 Uploading/Downloading Data to/from the GLCP

- Press [Off] to stop the motor before uploading or downloading data.
- Press [Main Menu] *parameter 0-50 LCP Copy* and press [OK].
- Select [1] *All to LCP* to upload data to the LCP or select [2] *All from LCP* to download data from the LCP.
- Press [OK]. A progress bar shows the uploading or downloading progress.
- Press [Hand On] or [Auto On] to return to normal operation.

3.1.9 Restoring Default Settings with LCP

NOTICE

Risk of losing programming, motor data, localization, and monitoring records by restoration of default settings. To provide a back-up, upload data to the LCP before initialization.

Restoring the default parameter settings is done by initialization of the frequency converter. Initialization is carried out through *parameter 14-22 Operation Mode* (recommended) or manually. Initialization does not reset the settings for *parameter 1-06 Clockwise Direction*.

- Initialization using *parameter 14-22 Operation Mode* does not reset frequency converter settings, such as operating hours, serial communication

selections, fault log, alarm log, and other monitoring functions.

- Manual initialization erases all motor, programming, localization, and monitoring data and restores factory default settings.

Recommended initialization procedure, via parameter 14-22 Operation Mode

1. Select *parameter 14-22 Operation Mode* and press [OK].
2. Select [2] *Initialisation* and press [OK].
3. Remove power to the unit and wait until the display turns off.
4. Apply power to the unit.

Default parameter settings are restored during start-up. This may take slightly longer than normal.

5. *Alarm 80, Drive initialised to default value* is shown.
6. Press [Reset] to return to operation mode.

Manual initialization procedure

1. Remove power to the unit and wait until the display turns off.
2. Press and hold [Status], [Main Menu], and [OK] at the same time on the GLCP, or press [Menu] and [OK] at the same time on the NLCP while applying power to the unit (approximately 5 s or until a click is heard and the fan starts).

Factory default parameter settings are restored during start-up. This may take slightly longer than normal.

Manual initialization does not reset the following frequency converter information:

- *Parameter 15-00 Operating hours*
- *Parameter 15-03 Power Up's*
- *Parameter 15-04 Over Temp's*
- *Parameter 15-05 Over Volt's*

3.2 Basic Programming

3.2.1 Asynchronous Motor Set-up

Enter the following motor data in the listed order. Find the information on the motor nameplate.

1. *Parameter 1-20 Motor Power.*
2. *Parameter 1-22 Motor Voltage.*
3. *Parameter 1-23 Motor Frequency.*
4. *Parameter 1-24 Motor Current.*
5. *Parameter 1-25 Motor Nominal Speed.*

For optimum performance in VVC⁺ mode, extra motor data is required to set up the following parameters.

6. *Parameter 1-30 Stator Resistance (Rs).*
7. *Parameter 1-31 Rotor Resistance (Rr).*
8. *Parameter 1-33 Stator Leakage Reactance (Xl).*
9. *Parameter 1-35 Main Reactance (Xh).*

The data is found in the motor datasheet (this data is typically not available on the motor nameplate). Run a complete AMA using *parameter 1-29 Automatic Motor Adaption (AMA) [1] Enable Complete AMA* or enter the parameters manually.

Application-specific adjustment when running VVC⁺

VVC⁺ is the most robust control mode. In most situations, it provides optimum performance without further adjustments. Run a complete AMA for best performance.

3.2.2 PM Motor Set-up in VVC⁺

Initial programming steps

1. Set *parameter 1-10 Motor Construction* to the following options to activate PM motor operation:
 - 1a [1] *PM, non salient SPM*
 - 1b [2] *PM, salient IPM, non Sat*
 - 1c [3] *PM, salient IPM, Sat*
2. Select [0] *Open Loop* in *parameter 1-00 Configuration Mode*.

NOTICE

Encoder feedback is not supported for PM motors.

Programming motor data

After selecting 1 of the PM motor options in *parameter 1-10 Motor Construction*, the PM motor-related parameters in *parameter groups 1-2* Motor Data, 1-3* Adv. Motor Data, and 1-4* Adv. Motor Data II* are active. Find the information on the motor nameplate and in the motor datasheet.

Program the following parameters in the listed order:

1. *Parameter 1-24 Motor Current.*
2. *Parameter 1-26 Motor Cont. Rated Torque.*
3. *Parameter 1-25 Motor Nominal Speed.*
4. *Parameter 1-39 Motor Poles.*
5. *Parameter 1-30 Stator Resistance (Rs).*

Enter line-to-common stator winding resistance (Rs). If only line-line data is available, divide the line-line value by 2 to achieve the line-to-common (starpoint) value.

It is also possible to measure the value with an ohmmeter, which also takes the resistance of the cable into account. Divide the measured value by 2 and enter the result.

6. **Parameter 1-37 d-axis Inductance (Ld).**
 Enter line-to-common direct axis inductance of the PM motor.
 If only line-to-line data is available, divide the line-line value by 2 to achieve the line-common (starpoint) value.
 It is also possible to measure the value with an inductance meter, which also takes the inductance of the cable into account. Divide the measured value by 2 and enter the result.

7. **Parameter 1-40 Back EMF at 1000 RPM.**
 Enter line-to-line back EMF of the PM motor at 1000 RPM mechanical speed (RMS value). Back EMF is the voltage generated by a PM motor when no frequency converter is connected and the shaft is turned externally. Back EMF is normally specified for nominal motor speed or for 1000 RPM measured between 2 lines. If the value is not available for a motor speed of 1000 RPM, calculate the correct value as follows: For example, if back EMF at 1800 RPM is 320 V, the back EMF at 1000 RPM is:
 Back EMF=(Voltage/RPM)x1000=(320/1800)x1000=178.
 Program this value for *parameter 1-40 Back EMF at 1000 RPM*.

Test motor operation

1. Start the motor at low speed (100–200 RPM). If the motor does not turn, check installation, general programming, and motor data.

Parking

This function is the recommended option for applications where the motor rotates at slow speed (for example windmilling in fan applications). *Parameter 2-06 Parking Current* and *parameter 2-07 Parking Time* are adjustable. Increase the factory setting of these parameters for applications with high inertia.

Start the motor at nominal speed. If the application does not run well, check the VVC⁺ PM settings. *Table 3.13* shows recommendations in different applications.

Application	Settings
Low inertia applications $I_{Load}/I_{Motor} < 5$	<ul style="list-style-type: none"> • Increase the value for <i>parameter 1-17 Voltage filter time const.</i> by factor 5–10. • Reduce the value for <i>parameter 1-14 Damping Gain</i>. • Reduce the value (<100%) for <i>parameter 1-66 Min. Current at Low Speed</i>.
Medium inertia applications $50 > I_{Load}/I_{Motor} > 5$	Keep calculated values.
High inertia applications $I_{Load}/I_{Motor} > 50$	Increase the values for <i>parameter 1-14 Damping Gain</i> , <i>parameter 1-15 Low Speed Filter Time Const.</i> , and <i>parameter 1-16 High Speed Filter Time Const.</i>
High load at low speed <30% (rated speed)	Increase the value for <i>parameter 1-17 Voltage filter time const.</i> Increase the value for <i>parameter 1-66 Min. Current at Low Speed</i> (>100% for longer time can overheat the motor).

Table 3.13 Recommendations in Different Applications

If the motor starts oscillating at a certain speed, increase *parameter 1-14 Damping Gain*. Increase the value in small steps.

Starting torque can be adjusted in *parameter 1-66 Min. Current at Low Speed*. 100% provides nominal torque as starting torque.

3.2.3 Automatic Motor Adaptation (AMA)

To optimize compatibility between the frequency converter and the motor in VVC⁺ mode, run AMA.

- The frequency converter builds a mathematical model of the motor for regulating output motor current, thus enhancing motor performance.
- Some motors may be unable to run the complete version of the test. In that case, select [2] *Enable reduced AMA* in *parameter 1-29 Automatic Motor Adaption (AMA)*.
- If warnings or alarms occur, see *chapter 6.1 Warnings and Alarms*.
- For best results, run this procedure on a cold motor.

To run AMA using the LCP

1. By default parameter setting, connect terminals 13 and 27 before running AMA.
2. Enter the *Main Menu*.
3. Go to *parameter group 1-** Load and Motor*.
4. Press [OK].
5. Set motor parameters using nameplate data for *parameter group 1-2* Motor Data*.
6. Set motor cable length in *parameter 1-42 Motor Cable Length*.
7. Go to *parameter 1-29 Automatic Motor Adaption (AMA)*.
8. Press [OK].
9. Select *[1] Enable complete AMA*.
10. Press [OK].
11. The test runs automatically and indicates when it is complete.

Depending on the power size, the AMA takes 3–10 minutes to complete.

NOTICE

The AMA function does not cause the motor to run and it does not harm the motor.

4 Parameter Descriptions

4.1 Parameters: 0-** Operation and Display

0-01 Language		
Select the language to be used in the display.		
Option:	Function:	
[0] *	English	
[1]	Deutsch	
[2]	Francais	
[3]	Dansk	
[4]	Spanish	
[5]	Italiano	
[28]	Bras.port	

0-03 Regional Settings		
Option:	Function:	
	NOTICE This parameter cannot be adjusted while the motor is running.	
[0] *	International	Activate <i>parameter 1-20 Motor Power [kW]</i> for setting the motor power in kW and set the default value of <i>parameter 1-23 Motor Frequency</i> to 50 Hz.
[1]	US	Activate <i>parameter 1-20 Motor Power [kW]</i> for setting the motor power in hp and set the default value of <i>parameter 1-23 Motor Frequency</i> to 60 Hz.

0-04 Operating State at Power-up (Hand)		
Option:	Function:	
	Select the operating mode upon reconnection of the frequency converter to mains voltage after power down in hand-on mode.	
[0]	Resume	Restart the frequency converter, maintaining the start/stop settings (applied by [Hand On/Off]) selected before the power-down of the frequency converter.
[1] *	Forced stop, ref=old	Restart the frequency converter with a saved local reference after mains voltage reappears and after pressing [Hand On].
[2]	Forced stop, ref=0	Reset the local reference to 0 upon restarting the frequency converter.

0-06 GridType		
Select the supply voltage, frequency, and type.		
Option:	Function:	
[0]	200-240V/50Hz/IT-grid	
[1]	200-240V/50Hz/Delta	
[2]	200-240V/50Hz	

0-06 GridType		
Select the supply voltage, frequency, and type.		
Option:	Function:	
[10]	380-440V/50Hz/IT-grid	
[11]	380-440V/50Hz/Delta	
[12]	380-440V/50Hz	
[20]	440-480V/50Hz/IT-grid	
[21]	440-480V/50Hz/Delta	
[22]	440-480V/50Hz	
[100]	200-240V/60Hz/IT-grid	
[101]	200-240V/60Hz/Delta	
[102]	200-240V/60Hz	
[110]	380-440V/60Hz/IT-grid	
[111]	380-440V/60Hz/Delta	
[112]	380-440V/60Hz	
[120]	440-480V/60Hz/IT-grid	
[121]	440-480V/60Hz/Delta	
[122]	440-480V/60Hz	

0-07 Auto DC Braking		
Option:	Function:	
	Protective function against overvoltage at coast in IT grid environment. This parameter is active only when [1] On is selected in this parameter, and IT-grid options are selected in <i>parameter 0-06 GridType</i> .	
[0]	Off	This function is not active.
[1] *	On	This function is active.

0-10 Active Set-up		
Select the set-up to control the frequency converter functions. Program parameters in set-ups 1-4. Use the factory set-up to return the initial state. Use multi set-up for remote control.		
Option:	Function:	
[1] *	Set-up 1	
[2]	Set-up 2	
[3]	Set-up 3	
[4]	Set-up 4	
[9]	Multi Set-up	

0-11 Programming Set-up		
Select the set-up to be programmed during operation; either the active set-up or the inactive set-up. The set-up number being edited flashes in the LCP.		
Option:	Function:	
[1]	Set-up 1	
[2]	Set-up 2	
[3]	Set-up 3	
[4]	Set-up 4	
[9] *	Active Set-up	

0-12 Link Setups		
Option:	Function:	
		The link ensures synchronizing of the <i>Not changeable during operation</i> parameter values enabling shift from 1 set-up to another during operation. If the set-ups are not linked, a change between them is not possible while the motor runs. Thus the set-up change does not occur until the motor is coasted.
[0]	Not linked	Leave parameters unchanged in both set-ups and cannot be changed while the motor runs.
[20] *	Linked	Copy <i>Not changeable during operation</i> parameters from 1 set-up to the other, so they are identical in both set-ups.

0-14 Readout: Edit Set-ups / Channel		
Range:	Function:	
0* [-2147483647 - 2147483647]	View the setting of <i>parameter 0-11 Programming Set-up</i> . Edit set-up for each communication channel. A means active set-up; F means factory; numbers indicate set-up code. Communication channels from right to left are LCP, FC-bus, USB, and HPFB1-5.	

0-16 Application Selection		
Option:	Function:	
		Select integrated application functions. When an application is selected, a set of related parameters are set automatically.
[0] *	None	
[1]	Simple Process Close Loop	
[2]	Local/Remote	
[3]	Speed Open Loop	
[4]	Simple Speed Close Loop	
[5]	Multi Speed	
[6]	OGD LA10	
[7]	OGD V210	

0-20 Display Line 1.1 Small		
Select a variable to show in line 1, left position.		
Option:	Function:	
[0]	None	
[37]	Display Text 1	
[38]	Display Text 2	
[39]	Display Text 3	
[748]	PCD Feed Forward	
[953]	Profibus Warning Word	
[1005]	Readout Transmit Error Counter	
[1006]	Readout Receive Error Counter	
[1230]	Warning Parameter	

0-20 Display Line 1.1 Small		
Select a variable to show in line 1, left position.		
Option:	Function:	
[1501]	Running Hours	
[1502]	kWh Counter	
[1600]	Control Word	
[1601]	Reference [Unit]	
[1602] *	Reference [%]	
[1603]	Status Word	
[1605]	Main Actual Value [%]	
[1609]	Custom Readout	
[1610]	Power [kW]	
[1611]	Power [hp]	
[1612]	Motor Voltage	
[1613]	Frequency	
[1614]	Motor current	
[1615]	Frequency [%]	
[1616]	Torque [Nm]	
[1617]	Speed [RPM]	
[1618]	Motor Thermal	
[1620]	Motor Angle	
[1622]	Torque [%]	
[1630]	DC Link Voltage	
[1633]	Brake Energy /2 min	
[1634]	Heatsink Temp.	
[1635]	Inverter Thermal	
[1636]	Inv. Nom. Current	
[1637]	Inv. Max. Current	
[1638]	SL Controller State	
[1639]	Control Card Temp.	
[1650]	External Reference	
[1652]	Feedback[Unit]	
[1653]	Digi Pot Reference	
[1657]	Feedback [RPM]	
[1660]	Digital Input	
[1661]	Terminal 53 Setting	
[1662]	Analog input 53	
[1663]	Terminal 54 Setting	
[1664]	Analog input 54	
[1665]	Analog output 42 [mA]	
[1666]	Digital Output	
[1667]	Pulse input 29[Hz]	
[1668]	Pulse Input 33 [Hz]	
[1669]	Pulse Output 27 [Hz]	
[1671]	Relay output	
[1672]	Counter A	
[1673]	Counter B	
[1674]	Prec. Stop Counter	
[1680]	Fieldbus CTW 1	
[1682]	Fieldbus REF 1	
[1684]	Comm. Option STW	
[1685]	FC Port CTW 1	
[1686]	FC Port REF 1	
[1690]	Alarm Word	

0-20 Display Line 1.1 Small		
Select a variable to show in line 1, left position.		
Option:	Function:	
[1691]	Alarm Word 2	
[1692]	Warning Word	
[1693]	Warning Word 2	
[1694]	Ext. Status Word	
[1695]	Ext. Status Word 2	
[1697]	Alarm Word 3	
[1890]	Process PID Error	
[1891]	Process PID Output	
[1892]	Process PID Clamped Output	
[1893]	Process PID Gain Scaled Output	
[2117]	Ext. 1 Reference [Unit]	
[2118]	Ext. 1 Feedback [Unit]	
[2119]	Ext. 1 Output [%]	
[3401]	PCD 1 Write For Application	
[3402]	PCD 2 Write For Application	
[3403]	PCD 3 Write For Application	
[3404]	PCD 4 Write For Application	
[3405]	PCD 5 Write For Application	
[3406]	PCD 6 Write For Application	
[3407]	PCD 7 Write For Application	
[3408]	PCD 8 Write For Application	
[3409]	PCD 9 Write For Application	
[3410]	PCD 10 Write For Application	
[3421]	PCD 1 Read For Application	
[3422]	PCD 2 Read For Application	
[3423]	PCD 3 Read For Application	
[3424]	PCD 4 Read For Application	
[3425]	PCD 5 Read For Application	
[3426]	PCD 6 Read For Application	
[3427]	PCD 7 Read For Application	
[3428]	PCD 8 Read For Application	
[3429]	PCD 9 Read For Application	
[3430]	PCD 10 Read For Application	
[3450]	Actual Position	
[3456]	Track Error	

0-21 Display Line 1.2 Small		
Select a variable to show in line 1, middle position.		
Option:	Function:	
[0]	None	
[37]	Display Text 1	
[38]	Display Text 2	
[39]	Display Text 3	
[748]	PCD Feed Forward	
[953]	Profibus Warning Word	
[1005]	Readout Transmit Error Counter	
[1006]	Readout Receive Error Counter	
[1230]	Warning Parameter	
[1501]	Running Hours	
[1502]	kWh Counter	
[1600]	Control Word	

0-21 Display Line 1.2 Small		
Select a variable to show in line 1, middle position.		
Option:	Function:	
[1601]	Reference [Unit]	
[1602]	Reference [%]	
[1603]	Status Word	
[1605]	Main Actual Value [%]	
[1609]	Custom Readout	
[1610]	Power [kW]	
[1611]	Power [hp]	
[1612]	Motor Voltage	
[1613]	Frequency	
[1614] *	Motor current	
[1615]	Frequency [%]	
[1616]	Torque [Nm]	
[1617]	Speed [RPM]	
[1618]	Motor Thermal	
[1620]	Motor Angle	
[1622]	Torque [%]	
[1630]	DC Link Voltage	
[1633]	Brake Energy /2 min	
[1634]	Heatsink Temp.	
[1635]	Inverter Thermal	
[1636]	Inv. Nom. Current	
[1637]	Inv. Max. Current	
[1638]	SL Controller State	
[1639]	Control Card Temp.	
[1650]	External Reference	
[1652]	Feedback[Unit]	
[1653]	Digi Pot Reference	
[1657]	Feedback [RPM]	
[1660]	Digital Input	
[1661]	Terminal 53 Setting	
[1662]	Analog input 53	
[1663]	Terminal 54 Setting	
[1664]	Analog input 54	
[1665]	Analog output 42 [mA]	
[1666]	Digital Output	
[1667]	Pulse input 29[Hz]	
[1668]	Pulse Input 33 [Hz]	
[1669]	Pulse Output 27 [Hz]	
[1671]	Relay output	
[1672]	Counter A	
[1673]	Counter B	
[1674]	Prec. Stop Counter	
[1680]	Fieldbus CTW 1	
[1682]	Fieldbus REF 1	
[1684]	Comm. Option STW	
[1685]	FC Port CTW 1	
[1686]	FC Port REF 1	
[1690]	Alarm Word	
[1691]	Alarm Word 2	
[1692]	Warning Word	
[1693]	Warning Word 2	

0-21 Display Line 1.2 Small		
Select a variable to show in line 1, middle position.		
Option:	Function:	
[1694]	Ext. Status Word	
[1695]	Ext. Status Word 2	
[1697]	Alarm Word 3	
[1890]	Process PID Error	
[1891]	Process PID Output	
[1892]	Process PID Clamped Output	
[1893]	Process PID Gain Scaled Output	
[2117]	Ext. 1 Reference [Unit]	
[2118]	Ext. 1 Feedback [Unit]	
[2119]	Ext. 1 Output [%]	
[3401]	PCD 1 Write For Application	
[3402]	PCD 2 Write For Application	
[3403]	PCD 3 Write For Application	
[3404]	PCD 4 Write For Application	
[3405]	PCD 5 Write For Application	
[3406]	PCD 6 Write For Application	
[3407]	PCD 7 Write For Application	
[3408]	PCD 8 Write For Application	
[3409]	PCD 9 Write For Application	
[3410]	PCD 10 Write For Application	
[3421]	PCD 1 Read For Application	
[3422]	PCD 2 Read For Application	
[3423]	PCD 3 Read For Application	
[3424]	PCD 4 Read For Application	
[3425]	PCD 5 Read For Application	
[3426]	PCD 6 Read For Application	
[3427]	PCD 7 Read For Application	
[3428]	PCD 8 Read For Application	
[3429]	PCD 9 Read For Application	
[3430]	PCD 10 Read For Application	
[3450]	Actual Position	
[3456]	Track Error	

0-22 Display Line 1.3 Small		
Select a variable to show in line 1, right position.		
Option:	Function:	
[0]	None	
[37]	Display Text 1	
[38]	Display Text 2	
[39]	Display Text 3	
[748]	PCD Feed Forward	
[953]	Profibus Warning Word	
[1005]	Readout Transmit Error Counter	
[1006]	Readout Receive Error Counter	
[1230]	Warning Parameter	
[1501]	Running Hours	
[1502]	kWh Counter	
[1600]	Control Word	
[1601]	Reference [Unit]	
[1602]	Reference [%]	
[1603]	Status Word	

0-22 Display Line 1.3 Small		
Select a variable to show in line 1, right position.		
Option:	Function:	
[1605]	Main Actual Value [%]	
[1609]	Custom Readout	
[1610] *	Power [kW]	
[1611]	Power [hp]	
[1612]	Motor Voltage	
[1613]	Frequency	
[1614]	Motor current	
[1615]	Frequency [%]	
[1616]	Torque [Nm]	
[1617]	Speed [RPM]	
[1618]	Motor Thermal	
[1620]	Motor Angle	
[1622]	Torque [%]	
[1630]	DC Link Voltage	
[1633]	Brake Energy /2 min	
[1634]	Heatsink Temp.	
[1635]	Inverter Thermal	
[1636]	Inv. Nom. Current	
[1637]	Inv. Max. Current	
[1638]	SL Controller State	
[1639]	Control Card Temp.	
[1650]	External Reference	
[1652]	Feedback[Unit]	
[1653]	Digi Pot Reference	
[1657]	Feedback [RPM]	
[1660]	Digital Input	
[1661]	Terminal 53 Setting	
[1662]	Analog input 53	
[1663]	Terminal 54 Setting	
[1664]	Analog input 54	
[1665]	Analog output 42 [mA]	
[1666]	Digital Output	
[1667]	Pulse input 29[Hz]	
[1668]	Pulse Input 33 [Hz]	
[1669]	Pulse Output 27 [Hz]	
[1671]	Relay output	
[1672]	Counter A	
[1673]	Counter B	
[1674]	Prec. Stop Counter	
[1680]	Fieldbus CTW 1	
[1682]	Fieldbus REF 1	
[1684]	Comm. Option STW	
[1685]	FC Port CTW 1	
[1686]	FC Port REF 1	
[1690]	Alarm Word	
[1691]	Alarm Word 2	
[1692]	Warning Word	
[1693]	Warning Word 2	
[1694]	Ext. Status Word	
[1695]	Ext. Status Word 2	
[1697]	Alarm Word 3	

0-22 Display Line 1.3 Small		
Select a variable to show in line 1, right position.		
Option:	Function:	
[1890]	Process PID Error	
[1891]	Process PID Output	
[1892]	Process PID Clamped Output	
[1893]	Process PID Gain Scaled Output	
[2117]	Ext. 1 Reference [Unit]	
[2118]	Ext. 1 Feedback [Unit]	
[2119]	Ext. 1 Output [%]	
[3401]	PCD 1 Write For Application	
[3402]	PCD 2 Write For Application	
[3403]	PCD 3 Write For Application	
[3404]	PCD 4 Write For Application	
[3405]	PCD 5 Write For Application	
[3406]	PCD 6 Write For Application	
[3407]	PCD 7 Write For Application	
[3408]	PCD 8 Write For Application	
[3409]	PCD 9 Write For Application	
[3410]	PCD 10 Write For Application	
[3421]	PCD 1 Read For Application	
[3422]	PCD 2 Read For Application	
[3423]	PCD 3 Read For Application	
[3424]	PCD 4 Read For Application	
[3425]	PCD 5 Read For Application	
[3426]	PCD 6 Read For Application	
[3427]	PCD 7 Read For Application	
[3428]	PCD 8 Read For Application	
[3429]	PCD 9 Read For Application	
[3430]	PCD 10 Read For Application	
[3450]	Actual Position	
[3456]	Track Error	

0-23 Display Line 2 Large		
Select a variable to show in line 2.		
Option:	Function:	
[0]	None	
[37]	Display Text 1	
[38]	Display Text 2	
[39]	Display Text 3	
[748]	PCD Feed Forward	
[953]	Profibus Warning Word	
[1005]	Readout Transmit Error Counter	
[1006]	Readout Receive Error Counter	
[1230]	Warning Parameter	
[1501]	Running Hours	
[1502]	kWh Counter	
[1600]	Control Word	
[1601]	Reference [Unit]	
[1602]	Reference [%]	
[1603]	Status Word	
[1605]	Main Actual Value [%]	
[1609]	Custom Readout	
[1610]	Power [kW]	

0-23 Display Line 2 Large		
Select a variable to show in line 2.		
Option:	Function:	
[1611]	Power [hp]	
[1612]	Motor Voltage	
[1613] *	Frequency	
[1614]	Motor current	
[1615]	Frequency [%]	
[1616]	Torque [Nm]	
[1617]	Speed [RPM]	
[1618]	Motor Thermal	
[1620]	Motor Angle	
[1622]	Torque [%]	
[1630]	DC Link Voltage	
[1633]	Brake Energy /2 min	
[1634]	Heatsink Temp.	
[1635]	Inverter Thermal	
[1636]	Inv. Nom. Current	
[1637]	Inv. Max. Current	
[1638]	SL Controller State	
[1639]	Control Card Temp.	
[1650]	External Reference	
[1652]	Feedback[Unit]	
[1653]	Digi Pot Reference	
[1657]	Feedback [RPM]	
[1660]	Digital Input	
[1661]	Terminal 53 Setting	
[1662]	Analog input 53	
[1663]	Terminal 54 Setting	
[1664]	Analog input 54	
[1665]	Analog output 42 [mA]	
[1666]	Digital Output	
[1667]	Pulse input 29[Hz]	
[1668]	Pulse Input 33 [Hz]	
[1669]	Pulse Output 27 [Hz]	
[1671]	Relay output	
[1672]	Counter A	
[1673]	Counter B	
[1674]	Prec. Stop Counter	
[1680]	Fieldbus CTW 1	
[1682]	Fieldbus REF 1	
[1684]	Comm. Option STW	
[1685]	FC Port CTW 1	
[1686]	FC Port REF 1	
[1690]	Alarm Word	
[1691]	Alarm Word 2	
[1692]	Warning Word	
[1693]	Warning Word 2	
[1694]	Ext. Status Word	
[1695]	Ext. Status Word 2	
[1697]	Alarm Word 3	
[1890]	Process PID Error	
[1891]	Process PID Output	
[1892]	Process PID Clamped Output	

0-23 Display Line 2 Large		
Select a variable to show in line 2.		
Option:	Function:	
[1893]	Process PID Gain Scaled Output	
[2117]	Ext. 1 Reference [Unit]	
[2118]	Ext. 1 Feedback [Unit]	
[2119]	Ext. 1 Output [%]	
[3401]	PCD 1 Write For Application	
[3402]	PCD 2 Write For Application	
[3403]	PCD 3 Write For Application	
[3404]	PCD 4 Write For Application	
[3405]	PCD 5 Write For Application	
[3406]	PCD 6 Write For Application	
[3407]	PCD 7 Write For Application	
[3408]	PCD 8 Write For Application	
[3409]	PCD 9 Write For Application	
[3410]	PCD 10 Write For Application	
[3421]	PCD 1 Read For Application	
[3422]	PCD 2 Read For Application	
[3423]	PCD 3 Read For Application	
[3424]	PCD 4 Read For Application	
[3425]	PCD 5 Read For Application	
[3426]	PCD 6 Read For Application	
[3427]	PCD 7 Read For Application	
[3428]	PCD 8 Read For Application	
[3429]	PCD 9 Read For Application	
[3430]	PCD 10 Read For Application	
[3450]	Actual Position	
[3456]	Track Error	

0-24 Display Line 3 Large		
Select a variable to show in line 3.		
Option:	Function:	
[0]	None	
[37]	Display Text 1	
[38]	Display Text 2	
[39]	Display Text 3	
[748]	PCD Feed Forward	
[953]	Profibus Warning Word	
[1005]	Readout Transmit Error Counter	
[1006]	Readout Receive Error Counter	
[1230]	Warning Parameter	
[1501]	Running Hours	
[1502] *	kWh Counter	
[1600]	Control Word	
[1601]	Reference [Unit]	
[1602]	Reference [%]	
[1603]	Status Word	
[1605]	Main Actual Value [%]	
[1609]	Custom Readout	
[1610]	Power [kW]	
[1611]	Power [hp]	
[1612]	Motor Voltage	
[1613]	Frequency	

0-24 Display Line 3 Large		
Select a variable to show in line 3.		
Option:	Function:	
[1614]	Motor current	
[1615]	Frequency [%]	
[1616]	Torque [Nm]	
[1617]	Speed [RPM]	
[1618]	Motor Thermal	
[1620]	Motor Angle	
[1622]	Torque [%]	
[1630]	DC Link Voltage	
[1633]	Brake Energy /2 min	
[1634]	Heatsink Temp.	
[1635]	Inverter Thermal	
[1636]	Inv. Nom. Current	
[1637]	Inv. Max. Current	
[1638]	SL Controller State	
[1639]	Control Card Temp.	
[1650]	External Reference	
[1652]	Feedback[Unit]	
[1653]	Digi Pot Reference	
[1657]	Feedback [RPM]	
[1660]	Digital Input	
[1661]	Terminal 53 Setting	
[1662]	Analog input 53	
[1663]	Terminal 54 Setting	
[1664]	Analog input 54	
[1665]	Analog output 42 [mA]	
[1666]	Digital Output	
[1667]	Pulse input 29[Hz]	
[1668]	Pulse Input 33 [Hz]	
[1669]	Pulse Output 27 [Hz]	
[1671]	Relay output	
[1672]	Counter A	
[1673]	Counter B	
[1674]	Prec. Stop Counter	
[1680]	Fieldbus CTW 1	
[1682]	Fieldbus REF 1	
[1684]	Comm. Option STW	
[1685]	FC Port CTW 1	
[1686]	FC Port REF 1	
[1690]	Alarm Word	
[1691]	Alarm Word 2	
[1692]	Warning Word	
[1693]	Warning Word 2	
[1694]	Ext. Status Word	
[1695]	Ext. Status Word 2	
[1697]	Alarm Word 3	
[1890]	Process PID Error	
[1891]	Process PID Output	
[1892]	Process PID Clamped Output	
[1893]	Process PID Gain Scaled Output	
[2117]	Ext. 1 Reference [Unit]	
[2118]	Ext. 1 Feedback [Unit]	

0-24 Display Line 3 Large		
Select a variable to show in line 3.		
Option:	Function:	
[2119]	Ext. 1 Output [%]	
[3401]	PCD 1 Write For Application	
[3402]	PCD 2 Write For Application	
[3403]	PCD 3 Write For Application	
[3404]	PCD 4 Write For Application	
[3405]	PCD 5 Write For Application	
[3406]	PCD 6 Write For Application	
[3407]	PCD 7 Write For Application	
[3408]	PCD 8 Write For Application	
[3409]	PCD 9 Write For Application	
[3410]	PCD 10 Write For Application	
[3421]	PCD 1 Read For Application	
[3422]	PCD 2 Read For Application	
[3423]	PCD 3 Read For Application	
[3424]	PCD 4 Read For Application	
[3425]	PCD 5 Read For Application	
[3426]	PCD 6 Read For Application	
[3427]	PCD 7 Read For Application	
[3428]	PCD 8 Read For Application	
[3429]	PCD 9 Read For Application	
[3430]	PCD 10 Read For Application	
[3450]	Actual Position	
[3456]	Track Error	

0-30 Custom Readout Unit		
Set a value to be shown in the LCP. The value has a linear, squared, or cubed relation to speed. This relation depends on the unit selected.		
Option:	Function:	
[0]	None	
[1] *	%	
[5]	PPM	
[10]	1/min	
[11]	RPM	
[12]	Pulse/s	
[20]	l/s	
[21]	l/min	
[22]	l/h	
[23]	m ³ /s	
[24]	m ³ /min	
[25]	m ³ /h	
[30]	kg/s	
[31]	kg/min	
[32]	kg/h	
[33]	t/min	
[34]	t/h	
[40]	m/s	
[41]	m/min	
[45]	m	
[60]	°C	
[70]	mbar	

0-30 Custom Readout Unit		
Set a value to be shown in the LCP. The value has a linear, squared, or cubed relation to speed. This relation depends on the unit selected.		
Option:	Function:	
[71]	bar	
[72]	Pa	
[73]	kPa	
[74]	m WG	
[80]	kW	
[120]	GPM	
[121]	gal/s	
[122]	gal/min	
[123]	gal/h	
[124]	CFM	
[127]	ft ³ /h	
[140]	ft/s	
[141]	ft/min	
[160]	°F	
[170]	psi	
[171]	lb/in ²	
[172]	in WG	
[173]	ft WG	
[180]	HP	

0-31 Custom Readout Min Value		
Range:	Function:	
0 CustomReadoutUnit*	[0 - 999999.99 CustomReadoutUnit]	This parameter sets the minimum value of the custom readout (occurs at 0 speed). It is only possible to select a value different from 0 when selecting a linear unit in <i>parameter 0-30 Custom Readout Unit</i> . For quadratic and cubic units, the minimum value is 0.

0-32 Custom Readout Max Value		
Range:	Function:	
100 CustomReadoutUnit*	[0.0 - 999999.99 CustomReadoutUnit]	This parameter sets the maximum value to be shown when the motor speed has reached the value set for <i>parameter 4-14 Motor Speed High Limit [Hz]</i> .

0-37 Display Text 1		
Range:	Function:	
[0 - 0]	Free text, for example used for the device tag of fieldbus application.	

0-38 Display Text 2		
Range:	Function:	
[0 - 0]	Free text, for example used for the location tag of fieldbus application.	

0-39 Display Text 3		
Range:	Function:	
[0 - 0]	Free text, for example used for the help tag of fieldbus application.	

0-40 [Hand on] Key on LCP		
Option:	Function:	
[0]	Disabled	Avoid accidental start of the frequency converter in hand-on mode.
[1] *	Enabled	[Hand On] is enabled.

0-42 [Auto on] Key on LCP		
Option:	Function:	
[0]	Disabled	Avoid accidental start of the frequency converter from LCP.
[1] *	Enabled	[Auto On] is enabled.

0-44 [Off/Reset] Key on LCP		
Option:	Function:	
[0]	Disabled	
[1] *	Enabled	
[7]	Enable Reset Only	

0-50 LCP Copy		
Option:	Function:	
[0] *	No copy	No function.
[1]	All to LCP	Copy all parameters in all set-ups from the frequency converter memory to the LCP. For service purposes, copy all parameters to the LCP after commissioning.
[2]	All from LCP	Copy all parameters in all set-ups from the LCP memory to the frequency converter memory.
[3]	Size indep. from LCP	Copy only the parameters that are independent of the motor size. This selection can be used to program several frequency converters with the same function without disturbing motor data that is already set.

0-51 Set-up Copy		
Use this parameter to copy parameters between set-ups.		
Option:	Function:	
[0] *	No copy	
[1]	Copy from setup 1	
[2]	Copy from setup 2	
[3]	Copy from setup 3	
[4]	Copy from setup 4	
[9]	Copy from Factory setup	

4.2 Parameters: 1-** Load and Motor

1-00 Configuration Mode		
Option:	Function:	
		Select the application control principle to be used when a remote reference (that is analog input or fieldbus) is active.
[0] *	Open Loop	Enable speed control (without feedback signal from motor) with automatic slip compensation for almost constant speed at varying loads. Compensations are active, but can be disabled in <i>parameter group 1-0* Load and Motor</i> .
[1]	Speed closed loop	Enable speed closed-loop control with feedback. For increased speed accuracy, provide a feedback signal and set the speed PID control. The speed control parameters are set in <i>parameter group 7-0* Speed PID Control</i> .
[2]	Torque closed loop	Enable torque closed-loop control with speed feedback. Only possible when option [1] VVC ⁺ is selected in <i>parameter 1-01 Motor Control Principle</i> .
[3]	Process Closed Loop	Enable the use of process control in the frequency converter. The process control parameters are set in <i>parameter groups 7-2* Process Ctrl. Feedback and 7-3* Process PID Ctrl.</i>
[4]	Torque open loop	
[7]	Extended PID Speed OL	

1-01 Motor Control Principle		
Option:	Function:	
[0]	U/f	<p>NOTICE When running U/f, control slip and load compensations are not included.</p> <p>Used for parallel-connected motors and/or special motor applications. Set the U/f settings in <i>parameter 1-55 U/f Characteristic - U</i> and <i>parameter 1-56 U/f Characteristic - F</i>.</p>
[1] *	VVC ⁺	<p>NOTICE When <i>parameter 1-10 Motor Construction</i> is set to PM-enabled options, only VVC⁺ option is available.</p> <p>Normal running mode, including slip and load compensations.</p>

1-03 Torque Characteristics		
Option:	Function:	
		Select the torque characteristic required. VT and AEO are both energy-saving operations.
[0] *	Constant torque	
[1]	Variable Torque	
[2]	Auto Energy Optim. CT	

1-06 Clockwise Direction		
Option:	Function:	
		<p>NOTICE This parameter cannot be adjusted while the motor is running.</p> <p>This parameter defines the term <i>clockwise</i> corresponding to the LCP direction arrow. Used for easy change of direction of shaft rotation without swapping motor wires.</p>
[0] *	Normal	The motor shaft turns in clockwise direction when frequency converter is connected U⇒U; V⇒V; and W⇒W to motor.
[1]	Inverse	The motor shaft turns in counterclockwise direction when frequency converter is connected U⇒U; V⇒V; and W⇒W to motor.

1-08 Motor Control Bandwidth		
Option:	Function:	
[0]	High	Suitable for high dynamic response.
[1]	Medium	Suitable for smooth steady-state operation.
[2] *	Low	Suitable for smooth steady-state operation with lowest dynamic response.
[3]	Adaptive 1	Optimized for smooth steady-state operation, with extra active damping.
[4]	Adaptive 2	Focus on low-inductance PM motors. This option is an alternative to [3] Adaptive 1.

1-10 Motor Construction		
Option:	Function:	
[0] *	Asynchron	For asynchronous motors.
[1]	PM, non-salient SPM	For permanent magnet (PM) motors with surface-mounted (non-salient) magnets. Refer to <i>parameter 1-14 Damping Gain</i> to <i>parameter 1-17 Voltage filter time const.</i> for details about optimizing the motor operation.
[2]	PM, salient IPM, non Sat.	For permanent magnet (PM) motors with interior (salient) magnets, without inductance saturation control.
[3]	PM, salient IPM, Sat.	For permanent magnet (PM) motors with interior (salient) magnets, with inductance saturation control.

1-14 Damping Gain		
Range:		Function:
120 %*	[0 - 250 %]	The damping gain stabilizes the PM machine. The value of damping gain controls the dynamic performance of the PM machine. High damping gain gives high dynamic performance, and low damping gain gives low dynamic performance. The dynamic performance is related to the machine data and load type. If the damping gain is too high or low, the control becomes unstable.

1-15 Low Speed Filter Time Const.		
Range:		Function:
Size related*	[0.01 - 20 s]	This time constant is used below 10% rated speed. Obtain quick control through a short damping time constant. However, if this value is too short, the control becomes unstable.

1-16 High Speed Filter Time Const.		
Range:		Function:
Size related*	[0.01 - 20 s]	This time constant is used above 10% rated speed. Obtain quick control through a short damping time constant. However, if this value is too short, the control becomes unstable.

1-17 Voltage filter time const.		
Range:		Function:
Size related*	[0.001 - 1 s]	Reduce the influence of high frequency ripple and system resonance in the calculation of supply voltage. Without this filter, the ripples in the currents can distort the calculated voltage and affect the stability of the system.

1-20 Motor Power		
Option:		Function:
[2]	0.12 kW - 0.16 hp	
[3]	0.18 kW - 0.25 hp	
[4]	0.25 kW - 0.33 hp	
[5]	0.37 kW - 0.5 hp	
[6]	0.55 kW - 0.75 hp	
[7]	0.75 kW - 1 hp	
[8]	1.1 kW - 1.5 hp	
[9]	1.5 kW - 2 hp	
[10]	2.2 kW - 3 hp	
[11]	3 kW - 4 hp	
[12]	3.7 kW - 5 hp	
[13]	4 kW - 5.4 hp	
[14]	5.5 kW - 7.5 hp	
[15]	7.5 kW - 10 hp	

1-20 Motor Power		
Option:		Function:
[16]	11 kW - 15 hp	
[17]	15 kW - 20 hp	
[18]	18.5 kW - 25 hp	
[19]	22 kW - 30 hp	
[20]	30 kW - 40 hp	

1-22 Motor Voltage		
Range:		Function:
Size related*	[50 - 1000 V]	Enter the nominal motor voltage according to the motor nameplate data. The default value corresponds to the nominal rated output of the unit.

1-23 Motor Frequency		
Range:		Function:
NOTICE This parameter cannot be adjusted while the motor is running.		
Size related*	[20 - 500 Hz]	Select the motor frequency value from the motor nameplate. For 87 Hz operation with 230/440 V motors, set the value according to the nameplate data for 230 V/50 Hz. Adapt <i>parameter 4-14 Motor Speed High Limit [Hz]</i> and <i>parameter 3-03 Maximum Reference</i> to the 87 Hz application.

1-24 Motor Current		
Range:		Function:
Size related*	[0.01 - 10000.00 A]	Enter the nominal motor current value from the motor nameplate data. This data is used for calculating motor torque, motor thermal protection, and so on.

1-25 Motor Nominal Speed		
Range:		Function:
Size related*	[50 - 60000 RPM]	Enter the nominal motor speed value from the motor nameplate data. This data is used for calculating automatic motor compensations.

1-26 Motor Cont. Rated Torque		
Range:		Function:
Size related*	[0.1 - 10000 Nm]	Enter the value from the motor nameplate data. The default value corresponds to the nominal rated output. This parameter is available when <i>parameter 1-10 Motor Construction</i> is set to [1] PM, non salient SPM, non Sat, [2] PM, salient IPM, non Sat, or [3] PM, salient IPM, Sat, that is, the

1-26 Motor Cont. Rated Torque	
Range:	Function:
	parameter is valid for PM, non-salient SPM, and salient IPM motors only.

1-29 Automatic Motor Adaption (AMA)		
Option:	Function:	
	<p>NOTICE</p> <p>This parameter cannot be adjusted while the motor is running.</p> <p>NOTICE</p> <p>Terminal 27 digital input (parameter 5-12 Terminal 27 Digital Input) has coast inverse as the default setting. This setting means that AMA cannot be performed if terminal 27 is switched off.</p> <p>The AMA function optimizes dynamic motor performance by automatically optimizing the advanced motor parameters (parameter 1-30 Stator Resistance (Rs) to parameter 1-35 Main Reactance (Xh)) while the motor is stationary.</p>	
[0] *	Off	No function.
[1]	Enable Complete AMA	<p>Depending on the option selected in parameter 1-10 Motor Construction, the AMA is performed on different parameters.</p> <ul style="list-style-type: none"> If [0] Asynchron is selected, the AMA is performed on: <ul style="list-style-type: none"> - Parameter 1-30 Stator Resistance (Rs). - Parameter 1-31 Rotor Resistance (Rr). - Parameter 1-33 Stator Leakage Reactance (X1). - Parameter 1-35 Main Reactance (Xh). If [1] PM, non-salient SPM, non Sat is selected, the AMA is performed on: <ul style="list-style-type: none"> - Parameter 1-30 Stator Resistance (Rs). - Parameter 1-37 d-axis Inductance (Ld). If [2] PM, salient IPM, non Sat is selected, the AMA is performed on:

1-29 Automatic Motor Adaption (AMA)		
Option:	Function:	
		<ul style="list-style-type: none"> - Parameter 1-30 Stator Resistance (Rs). - Parameter 1-37 d-axis Inductance (Ld). - Parameter 1-38 q-axis Inductance (Lq). • If [3] PM, salient IPM, Sat is selected, the AMA is performed on: <ul style="list-style-type: none"> - Parameter 1-30 Stator Resistance (Rs). - Parameter 1-37 d-axis Inductance (Ld). - Parameter 1-38 q-axis Inductance (Lq). - Parameter 1-44 d-axis Inductance Sat. (LdSat). - Parameter 1-45 q-axis Inductance Sat. (LqSat).
[2]	Enable Reduced AMA	Perform a reduced AMA of the stator resistance R_s (parameter 1-30 Stator Resistance (Rs)) in the system only. If an LC filter is used between the frequency converter and the motor, select this option.

When parameter 1-10 Motor Construction is set to options that enable permanent motor mode, the only option available is [1] Enable Complete AMA.

Activate the AMA function by pressing [Hand On] after selecting [1] Enable Complete AMA or [2] Enable Reduced AMA. After a normal sequence, the display reads: Press [OK] to finish AMA. After pressing [OK], the frequency converter is ready for operation.

NOTICE

- For the best adaptation of the frequency converter, run AMA on a cold motor.
- AMA cannot be performed while the motor is running.

NOTICE

Avoid generating external torque during AMA.

NOTICE

If 1 of the settings in *parameter group 1-2* Motor Data* is changed, the advanced motor parameters, *parameter 1-30 Stator Resistance (Rs)* to *parameter 1-39 Motor Poles*, return to default setting.

If LC filter is used, set the frequency converter to run in U/f control mode (recommended), or perform reduced AMA in VVC+ mode. If LC filter is not used, perform complete AMA.

1-30 Stator Resistance (Rs)		
Range:		Function:
Size related*	[0.0 - 9999.000 Ohm]	NOTICE This parameter cannot be adjusted while the motor is running. Set the stator resistance value. Enter the value from a motor datasheet or perform an AMA on a cold motor.

1-31 Rotor Resistance (Rr)		
Range:		Function:
Size related*	[0 - 9999.000 Ohm]	Enter the rotor resistance value. Obtain the value from a motor datasheet or by performing an AMA on a cold motor. The default setting is calculated by the frequency converter from the motor nameplate data.

1-33 Stator Leakage Reactance (X1)		
Range:		Function:
Size related*	[0.0 - 9999.000 Ohm]	Set the stator leakage reactance value. Obtain the value from a motor datasheet or perform an AMA on a cold motor. The default setting is calculated by the frequency converter from the motor nameplate data.

1-35 Main Reactance (Xh)		
Range:		Function:
Size related*	[0.0 - 9999.00 Ohm]	Set the main reactance of the motor using 1 of these methods: <ul style="list-style-type: none"> • Run an AMA on a cold motor. The frequency converter measures the value from the motor. • Enter the X_h value manually. Obtain the value from the motor supplier. • Use the X_h default setting. The frequency converter establishes the setting based on the motor nameplate data.

1-37 d-axis Inductance (Ld)		
Range:		Function:
Size related*	[0 - 1000 mH]	Enter the value of the d-axis inductance. Obtain the value from the permanent magnet motor datasheet.

1-38 q-axis Inductance (Lq)		
Range:		Function:
Size related*	[0.000 - 1000 mH]	NOTICE This parameter cannot be adjusted while the motor is running. Set the value of the q-axis inductance. Find the value in the motor datasheet.

1-39 Motor Poles		
Range:		Function:
Size related*	[2 - 100]	NOTICE This parameter cannot be adjusted while the motor is running. Enter the number of motor poles. The motor pole value is always an even number, because it refers to the total pole numbers, not pairs of poles.

1-40 Back EMF at 1000 RPM		
Range:		Function:
Size related*	[0 - 9000 V]	Set the nominal back EMF for the motor when running at 1000 RPM. Back EMF is the voltage generated by a PM motor when no frequency converter is connected and the shaft is turned externally. Back EMF is normally specified

1-40 Back EMF at 1000 RPM		
Range:		Function:
		for nominal motor speed or for 1000 RPM measured between 2 lines. If the value is not available for a motor speed of 1000 RPM, calculate the correct value as follows: If back EMF is, for example, 320 V at 1800 RPM, it can be calculated at 1000 RPM: Example Back EMF 320 V at 1800 RPM. Back EMF = (Voltage/RPM)*1000 = (320/1800)*1000 = 178. This parameter is only active when <i>parameter 1-10 Motor Construction</i> is set to options that enable PM (permanent magnet) motors. NOTICE When using PM motors, it is recommended to use brake resistors.

1-42 Motor Cable Length		
Range:		Function:
50 m*	[0 - 100 m]	Set the motor cable length in meters.

1-43 Motor Cable Length Feet		
Range:		Function:
164 ft*	[0 - 328 ft]	Set the motor cable length. The length unit is foot.

1-44 d-axis Inductance Sat. (LdSat)		
Range:		Function:
Size related	[0 - 1000 mH]	This parameter is active only when <i>parameter 1-10 Motor Construction</i> is set to [3] PM, salient IPM, Sat. This parameter corresponds to the saturation inductance of d-axis. The default value is the value set in <i>parameter 1-37 d-axis Inductance (Ld)</i> . In most cases, do not change the default value. If the motor supplier provides the saturation curve, enter the d-axis inductance value, which is 100% of the nominal current.

1-45 q-axis Inductance Sat. (LqSat)		
Range:		Function:
Size related*	[0 - 1000 mH]	This parameter is active only when <i>parameter 1-10 Motor Construction</i> is set to [3] PM, salient IPM, Sat. This parameter corresponds to the q-axis saturation inductance. The default value is the value set in <i>parameter 1-38 q-axis Inductance (Lq)</i> . In most cases, do not change the default value. If the motor supplier provides the saturation curve, enter

1-45 q-axis Inductance Sat. (LqSat)		
Range:		Function:
		the q-axis inductance value, which is 100% of the nominal current.

1-46 Position Detection Gain		
Range:		Function:
100 %*	[20 - 200 %]	Adjust the amplitude of the test pulse during position detection at start. Adjust this parameter to improve the position measurement.

1-48 Current at Min Inductance for d-axis		
Range:		Function:
100 %	[20 - 200 %]	Use this parameter to set the inductance saturation point.

1-49 Current at Min Inductance for q-axis		
Range:		Function:
100 %	[20 - 200 %]	This parameter specifies the saturation curve of the q-inductance values. From 20–100% of this parameter, the inductance is linearly approximated due to <i>parameter 1-38 q-axis Inductance (Lq)</i> and <i>parameter 1-45 q-axis Inductance Sat. (LqSat)</i> . These parameters are related to the motor nameplate load compensations, the application load type, and the electronic brake function for quick stop/hold of the motor.

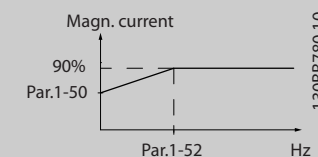
1-50 Motor Magnetisation at Zero Speed		
Range:		Function:
100 %*	[0 - 300 %]	Use this parameter along with <i>parameter 1-52 Min Speed Normal Magnetising [Hz]</i> to obtain a different thermal load on the motor when running at low speed. Enter a value that is a percentage of the rated magnetizing current. If the setting is too low, the torque on the motor shaft may be reduced.  <p>The graph shows 'Magn. current' on the y-axis and 'Hz' on the x-axis. A line starts at a point labeled '90%' on the y-axis and 'Par.1-50' on the x-axis. The line rises linearly to a point labeled '130BB780.10' on the y-axis and 'Par.1-52' on the x-axis. After this point, the line becomes horizontal.</p>
Illustration 4.1 Motor Magnetization		

1-52 Min Speed Normal Magnetising [Hz]		
Range:		Function:
1 Hz*	[0.1 - 10.0 Hz]	Set the required frequency for normal magnetizing current. Use this parameter along with <i>parameter 1-50 Motor Magnetisation at Zero Speed</i> , also see <i>Illustration 4.1</i> .

1-55 U/f Characteristic - U		
Range:	Function:	
Size related* [0 - 1000 V]	Enter voltage at each frequency point to manually form a U/f characteristic matching motor. Frequency points are defined in <i>parameter 1-56 U/f Characteristic - F</i> .	

1-56 U/f Characteristic - F		
Range:	Function:	
Size related* [0 - 500.0 Hz]	Enter frequency points to form a U/f characteristic matching motor. Voltage at each point is defined in <i>parameter 1-55 U/f Characteristic - U</i> . Make a U/f characteristic based on 6 definable voltages and frequencies, see <i>Illustration 4.2</i> .	
<p>Illustration 4.2 Example of U/f Characteristic</p>		

1-60 Low Speed Load Compensation		
Range:	Function:	
100 %* [0 - 300 %]	Enter the low-speed voltage compensation value in percent. This parameter is used for optimizing the low-speed load performance. This parameter is only active if <i>parameter 1-10 Motor Construction = [0] Asynchron</i> .	

1-61 High Speed Load Compensation		
Range:	Function:	
100 %* [0 - 300 %]	Enter the high-speed load voltage compensation value in percent. This parameter is used for optimizing the high-speed load performance. This parameter is only active if <i>parameter 1-10 Motor Construction = [0] Asynchron</i> .	

1-62 Slip Compensation		
Range:	Function:	
Size related* [-400 - 399.0 %]	Enter the % value for slip compensation to compensate for tolerance in the value of $n_{M,N}$. Slip compensation is calculated automatically, that is, based on the nominal motor speed $n_{M,N}$.	

1-63 Slip Compensation Time Constant		
Range:	Function:	
0.1 s* [0.05 - 5 s]	Enter the slip compensation reaction speed. A high value results in slow reaction, and a low value results in quick reaction. If low-frequency resonance problems occur, use a longer time setting.	

1-64 Resonance Dampening		
Range:	Function:	
100 %* [0 - 500 %]	Enter the resonance dampening value. Set <i>parameter 1-64 Resonance Dampening</i> and <i>parameter 1-65 Resonance Dampening Time Constant</i> to help eliminate high-frequency resonance problems. To reduce resonance oscillation, increase the value of <i>parameter 1-64 Resonance Dampening</i> .	

1-65 Resonance Dampening Time Constant		
Range:	Function:	
0.005 s* [0.001 - 0.05 s]	Set <i>parameter 1-64 Resonance Dampening</i> and <i>parameter 1-65 Resonance Dampening Time Constant</i> to help eliminate high-frequency resonance problems. Enter the time constant that provides the best dampening.	

1-66 Min. Current at Low Speed		
Range:	Function:	
50 %* [0 - 120 %]	Enter the minimum motor current at low speed. Increasing this current improves motor torque at low speed. <i>Parameter 1-66 Min. Current at Low Speed</i> is enabled only for PM motor.	

1-70 PM Start Mode		
Option:		
Select the PM motor start-up mode. To initialize the VVC ⁺ control core for previously free-running PM motor. Active for PM motors in VVC ⁺ only if the motor is stopped (or running at very low speed).		
Option:	Function:	
[0] *	Rotor Detection	Estimate the electrical angle of the rotor and uses this angle as a starting point. This option is the standard selection for industrial applications. If flystart detects that the motor runs at low speed or has stopped, the frequency converter detects the rotor position (the angle), and starts the motor from that position.
[1]	Parking	The parking function applies DC current across the stator winding and rotates the rotor to electrical 0 position. This option is typically for pump and fan applications. If flystart detects that the motor runs at low

1-70 PM Start Mode		
Select the PM motor start-up mode. To initialize the VVC ⁺ control core for previously free-running PM motor. Active for PM motors in VVC ⁺ only if the motor is stopped (or running at very low speed).		
Option:	Function:	
	speed or has stopped, the frequency converter sends out a DC current to make the motor park at an angle and then start the motor from that position.	

1-71 Start Delay		
Range:	Function:	
0 s* [0 - 10 s]	This parameter enables a delay of the starting time. The frequency converter begins with the start function selected in <i>parameter 1-72 Start Function</i> . Set the start delay time until acceleration is to begin.	

1-72 Start Function		
Option:	Function:	
	Select the start function during start delay. This parameter is linked to <i>parameter 1-71 Start Delay</i> .	
[0]	DC Hold/delay time	Energize motor with a DC hold current (<i>parameter 2-00 DC Hold/Motor Preheat Current</i>) during the start delay time.
[1]	DC-Brake/delay time	Energize motor with a DC hold current (<i>parameter 2-01 DC Brake Current</i>) during the start delay time.
[2]	Coast/delay time*	Motor coasted during the start delay time (inverter off).
[3]	Start speed cw	Only possible with VVC ⁺ . Regardless of the value applied by the reference signal, the output speed applies the setting of the start speed in <i>parameter 1-75 Start Speed [Hz]</i> and the output current corresponds to the setting of the start current in <i>parameter 1-76 Start Current</i> . This function is typically used in hoisting applications without counterweight and especially in applications with a cone-motor, where the start is clockwise, followed by rotation in the reference direction.
[4]	Horizontal operation	Only possible with VVC ⁺ . For obtaining the function described in <i>parameter 1-75 Start Speed [Hz]</i> and <i>parameter 1-76 Start Current</i> during the start delay time. The motor rotates in the reference direction. If the reference signal equals 0, <i>parameter 1-75 Start Speed [Hz]</i> is ignored and the output speed equals 0. The output current corresponds to the setting of the start current in <i>parameter 1-76 Start Current</i> .

1-72 Start Function		
Option:	Function:	
[5]	VVC ⁺ clockwise	The start current is calculated automatically. This function uses the start speed in the start delay time only.

1-73 Flying Start		
Option:	Function:	
	<p>NOTICE</p> <p>This parameter cannot be changed while the motor is running.</p> <p>NOTICE</p> <p>To obtain the best flying start performance, the advanced motor data, <i>parameter 1-30 Stator Resistance (Rs)</i> to <i>parameter 1-35 Main Reactance (Xh)</i> must be correct.</p> <p>Catch a motor which is spinning freely due to a mains dropout.</p>	
[0]	Disabled	No function.
[1]	Enabled	Enable the frequency converter to catch and control a spinning motor. When <i>parameter 1-73 Flying Start</i> is enabled, <i>parameter 1-71 Start Delay</i> , and <i>parameter 1-72 Start Function</i> have no function.
[2]	Enabled Always	Enable flying start at every start command.
[3]	Enabled Ref. Dir.	Enable the frequency converter to catch and control a spinning motor. The search is performed only in the reference direction.
[4]	Enab. Always Ref. Dir.	Enable flying start at every start command. The search is performed only in the reference direction.

1-75 Start Speed [Hz]		
Range:	Function:	
Size related* [0 - 500.0 Hz]	This parameter can be used for hoist applications (cone rotor). Set a motor start speed. After the start signal, the output speed leaps to the set value. Set the start function in <i>parameter 1-72 Start Function</i> to [3] Start speed cw, [4] Horizontal operation, or [5] VVC ⁺ clockwise, and set a start delay time in <i>parameter 1-71 Start Delay</i> .	

1-76 Start Current		
Range:	Function:	
Size related* [0 - 10000 A]	Some motors, for example cone rotor motors, need extra current/starting speed to disengage the rotor. To obtain this boost,	

1-76 Start Current	
Range:	Function:
	set the required current in this parameter. Set <i>parameter 1-72 Start Function</i> to [3] <i>Start speed cw</i> or [4] <i>Horizontal operation</i> , and set a start delay time in <i>parameter 1-71 Start Delay</i> .

1-78 Compressor Start Max Speed [Hz]	
Range:	Function:
0 Hz* [0 - 500 Hz]	This parameter enables high starting torque. The time from the start signal is given until the speed exceeds the speed set in this parameter becomes a start zone. In the start zone, the current limit and motoric torque limit are set to the maximum possible value for the frequency converter/motor combination. The time without protection from the current limit and torque limit must not exceed the value set in <i>parameter 1-79 Compressor Start Max Time to Trip</i> . Otherwise, the frequency converter trips with <i>alarm 18, Start Failed</i> .

1-79 Compressor Start Max Time to Trip	
Range:	Function:
5 s* [0 - 10 s]	The time from the start signal is given until the speed exceeds the speed set in <i>parameter 1-78 Compressor Start Max Speed [Hz]</i> must not exceed the time set in this parameter. Otherwise, the frequency converter trips with <i>alarm 18, Start Failed</i> . Any time set in <i>parameter 1-71 Start Delay</i> for use of a start function must be executed within the time limit.

1-80 Function at Stop	
Option:	Function:
	Select the frequency converter function after a stop command or after the speed is ramped down to the settings in <i>parameter 1-82 Min Speed for Function at Stop [Hz]</i> . Available selections depend on the setting in <i>parameter 1-10 Motor Construction</i> . <ul style="list-style-type: none"> • [0] <i>Asynchron.</i> <ul style="list-style-type: none"> - [0] <i>Coast.</i> - [1] <i>DC hold.</i> - [3] <i>Pre-magnetizing.</i> • [1] <i>PM, non-salient SPM, non Sat.</i> • [2] <i>PM, salient IPM, non Sat.</i> • [3] <i>PM, salient IPM, Sat.</i> <ul style="list-style-type: none"> - [0] <i>Coast.</i> - [1] <i>DC hold.</i>

1-80 Function at Stop		
Option:	Function:	
[0] *	Coast	Leave the motor in free mode.
[1]	DC hold / Motor Preheat	Energize the motor with a DC hold current (see <i>parameter 2-00 DC Hold/Motor Preheat Current</i>).
[3]	Pre-magnetizing	Build up a magnetic field while the motor is stopped. This allows the motor to produce torque quickly at commands (asynchronous motors only). This pre-magnetizing function does not help the very first start command. Two different solutions are available to pre-magnetize the machine for the first start command: <ol style="list-style-type: none"> 1. Start the frequency converter with a 0 RPM reference and wait 2–4 rotor time constants (see the equation below) before increasing the speed reference. 2. <ol style="list-style-type: none"> 2a Set <i>parameter 1-71 Start Delay</i> to the pre-magnetize time (2–4 rotor time constants). 2b Set <i>parameter 1-72 Start Function</i> to [0] <i>DC hold</i>. 2c Set the DC-hold current magnitude (<i>parameter 2-00 DC Hold/Motor Preheat Current</i>) to be equal to $I_{pre-mag} = U_{nom} / (1.73 \times X_h)$. <p>Sample rotor time constants= $(X_h + X_2) / (6.3 \times Freq_{nom} \times R_r)$ 1 kW=0.2 s 10 kW=0.5 s 100 kW=1.7 s</p>

1-82 Min Speed for Function at Stop [Hz]	
Range:	Function:
0 Hz* [0 - 20 Hz]	Set the output frequency at which to activate <i>parameter 1-80 Function at Stop</i> .

1-83 Precise Stop Function		
Option:	Function:	
[0] *	Precise ramp stop	Only optimal when the operational speed (for example the operational speed of a conveyor belt) is constant. This is an open-loop control. Achieves high repetitive precision at the stopping point.
[1]	Counter stop with reset	Count the number of pulses, typically from an encoder, and generates a stop signal after a preprogrammed number of pulses

1-83 Precise Stop Function		
Option:	Function:	
		defined in <i>parameter 1-84 Precise Stop Counter Value</i> , which has been received at terminal 29 or terminal 33. This is a direct feedback with one-way closed-loop control. The counter function is activated (starts timing) at the edge of the start signal (when it changes from stop to start). After each precise stop, the number of pulses counted during ramp down to 0 RPM is reset.
[2]	Counter stop without reset	Same as [1] <i>Counter stop with reset</i> , but the number of pulses counted during ramp down to 0 RPM is deducted from the counter value entered in <i>parameter 1-84 Precise Stop Counter Value</i> . This reset function can be used to compensate for the extra distance done during ramping down, and to reduce the impacts of gradual wear of mechanical parts.
[3]	Speed compensated stop	Stop at precisely the same point, regardless of the present speed. The stop signal is delayed internally when the present speed is lower than the maximum speed (set in <i>parameter 4-19 Max Output Frequency</i>). The delay is calculated on the basis of the reference speed of the frequency converter and not based on the actual speed. Make sure that the frequency converter has ramped up before activating the speed compensated stop.
[4]	Speed compensated counter stop with reset	Same as [3] <i>Speed compensated stop</i> , but after each precise stop, the number of pulses counted during ramp down to 0 RPM is reset.
[5]	Speed compensated counter stop without reset	Same as [3] <i>Speed compensated stop</i> , but the number of pulses counted during ramp down to 0 RPM is deducted from the counter value entered in <i>parameter 1-84 Precise Stop Counter Value</i> . This reset function can be used to compensate for the extra distance done during ramping down and to reduce the impacts of gradual wear of mechanical parts.

1-84 Precise Stop Counter Value		
Range:	Function:	
100000* [0 - 999999999]	Enter the counter value to be used in the integrated precise stop function in <i>parameter 1-83 Precise Stop Function</i> . The maximum permissible frequency at terminal 29 or 33 is 32 kHz.	

1-85 Precise Stop Speed Compensation Delay		
Range:	Function:	
10 ms* [0 - 100 ms]	Enter the delay time for sensors, PLCs, and so on for use in <i>parameter 1-83 Precise Stop Function</i> . In speed-compensated stop mode, the delay time at different frequencies has a major influence on the stop function.	

1-88 AC Brake Gain		
Range:	Function:	
1.4* [1.0 - 2.0]	This parameter is used to set AC brake power capability (set ramp-down time when inertia is constant). In the condition that the DC-link voltage is not higher than DC-link voltage trip value, the generator torque can be adjusted with this parameter. The higher AC brake gain is, the stronger the brake capability is. It equals to 1.0 means that there is no AC brake capability.	
<p>NOTICE</p> <p>If there is continuous generator torque, higher generator torque causes higher motor current, and the motor becomes hot. In this condition, the <i>parameter 2-16 AC Brake, Max current</i> can be used to protect the motor from overheating.</p>		

1-90 Motor Thermal Protection		
Option:	Function:	
[0] *	No protection	Continuously overloaded motor, when no warning or trip of the frequency converter is required.
[1]	Thermistor warning	Activates a warning when the connected thermistor in the motor reacts on a motor overtemperature.
[2]	Thermistor trip	Stops (trips) the frequency converter when the connected thermistor in the motor reacts on a motor overtemperature. The thermistor cutout value must be >3 kΩ. Integrate a thermistor (PTC sensor) in the motor for winding protection.
[3]	ETR warning 1	Calculates the load and activates a warning in the display when the motor is overloaded. Program a warning signal via 1 of the digital outputs.
[4]	ETR trip 1	Calculates the load and stops (trips) the frequency converter when the motor is overloaded. Program a warning signal via 1 of the digital outputs. The signal appears in the event of a warning and if the frequency converter trips (thermal warning).

4

1-90 Motor Thermal Protection	
Option:	Function:
[22]	ETR Trip - Extended Detection

1-93 Thermistor Source	
Option:	Function:
	<p>NOTICE This parameter cannot be changed while the motor is running.</p> <p>NOTICE Set the digital input to [0] PNP - Active at 24 V in parameter 5-00 Digital I/O Mode.</p> <p>Select the input to which the thermistor (PTC sensor) should be connected. An analog input option [1] Analog Input 53 or [2] Analog Input 54 cannot be selected if the analog input is already in use as a reference source (selected in parameter 3-15 Reference 1 Source, parameter 3-16 Reference 2 Source, or parameter 3-17 Reference 3 Source).</p>
[0] *	None
[1]	Analog Input 53
[2]	Analog Input 54
[3]	Digital input 18
[4]	Digital input 19
[5]	Digital input 32
[6]	Digital input 33

4.3 Parameters: 2-** Brakes

2-00 DC Hold/Motor Preheat Current		
Range:	Function:	
50 % *	[0 - 160 %]	Set the holding current as a percentage of the rated motor current $I_{M,N}$ <i>parameter 1-24 Motor Current</i> . This parameter holds the motor function (holding torque) or pre-heats the motor. This parameter is active if [0] DC hold is selected in <i>parameter 1-72 Start Function</i> , or if [1] DC hold/pre-heat is selected in <i>parameter 1-80 Function at Stop</i> .
<p>NOTICE</p> <p>The maximum value depends on the rated motor current. Avoid 100% current for too long. It may damage the motor.</p>		

2-01 DC Brake Current		
Range:	Function:	
50 % *	[0 - 150 %]	<p>NOTICE</p> <p>MOTOR OVERHEATING</p> <p>The maximum value depends on the rated motor current.</p> <p>To avoid motor damage caused by overheating, do not run at 100% for too long.</p> <p>Set current as % of rated motor current, <i>parameter 1-24 Motor Current</i>. When speed is below the limit set in <i>parameter 2-04 DC Brake Cut In Speed</i>, or when the DC-brake inverse function is active (in <i>parameter group 5-1* Digital Inputs</i> set to [5] DC-brake inverse; or via the serial port), a DC-brake current is applied on a stop command. See <i>parameter 2-02 DC Braking Time</i> for duration.</p>

2-02 DC Braking Time		
Range:	Function:	
10 s*	[0 - 60 s]	Set the duration of the DC-brake current set in <i>parameter 2-01 DC Brake Current</i> , once activated.

2-04 DC Brake Cut In Speed		
Range:	Function:	
0 Hz* *	[0 - 500 Hz]	This parameter is for setting the DC brake cut-in speed at which the DC brake current <i>parameter 2-01 DC Brake Current</i> is to be active, with a stop command.

2-06 Parking Current		
Range:	Function:	
100 %*	[0 - 150 %]	Set current as percentage of rated motor current, <i>parameter 1-24 Motor Current</i> .

2-07 Parking Time		
Range:	Function:	
3 s*	[0.1 - 60 s]	Set the duration of the parking current set in <i>parameter 2-06 Parking Current</i> , once activated.

2-10 Brake Function		
Option:	Function:	
[0] *	Off	No brake resistor is installed.
[1]	Resistor brake	A brake resistor is incorporated in the system for dissipating surplus brake energy as heat. Connecting a brake resistor allows a higher DC-link voltage during braking (generating operation). The brake resistor function is only active in frequency converters with an integral dynamic brake.
[2]	AC brake	Improve braking without using a brake resistor. This parameter controls an overmagnetization of the motor when running with a generative load. This function can improve the OVC function. Increasing the electrical losses in the motor allows the OVC function to increase braking torque without exceeding the voltage limit.
<p>NOTICE</p> <p>The AC brake is not as efficient as dynamic braking with resistor.</p> <p>AC brake is for VVC+ mode in both open and closed loop.</p>		

2-11 Brake Resistor (ohm)		
Range:	Function:	
Size related* *	[0 - 65535 Ohm]	Set the brake resistor value in Ω . This value is used for monitoring the power to the brake resistor. <i>Parameter 2-11 Brake Resistor (ohm)</i> is only active in frequency converters with an integral dynamic brake. Use this parameter for values without decimals.

2-12 Brake Power Limit (kW)		
Range:	Function:	
Size related* *	[0.001 - 2000 kW]	<p><i>Parameter 2-12 Brake Power Limit (kW)</i> is the expected average power dissipated in the brake resistor over a period of 120 s. It is used as the monitoring limit for <i>parameter 16-33 Brake Energy Average</i> and specifies when a warning/alarm is given. To calculate <i>parameter 2-12 Brake Power Limit (kW)</i>, the following formula can be used.</p> $P_{br,avg}[W] = \frac{U_{br}^2[V] \times t_{br}[s]}{R_{br}[\Omega] \times T_{br}[s]}$

2-12 Brake Power Limit (kW)		
Range:	Function:	
	<p>$P_{br,avg}$ is the average power dissipated in the brake resistor. R_{br} is the resistance of the brake resistor. t_{br} is the active braking time within the 120 s period T_{br}. U_{br} is the DC voltage where the brake resistor is active. For T4 units, the DC voltage is 770 V, which can be reduced by <i>parameter 2-14 Brake voltage reduce</i>.</p> <p>NOTICE</p> <p>If R_{br} is not known or if T_{br} is different from 120 s, the practical approach is to run the brake application, read out <i>parameter 16-33 Brake Energy Average</i>, and then enter this value + 20% in <i>parameter 2-12 Brake Power Limit (kW)</i>.</p>	

2-14 Brake voltage reduce		
Range:	Function:	
0 V*	[0 - 70 V]	Setting this parameter may change the brake resistor (<i>parameter 2-11 Brake Resistor (ohm)</i>).

2-16 AC Brake, Max current		
Range:	Function:	
100 %*	[0 - 160 %]	Enter the maximum allowed current when using AC brake to avoid overheating of motor windings.
	<p>NOTICE</p> <p><i>Parameter 2-16 AC Brake, Max current is not available for all PM motors, for example, all of the PM options in parameter 1-10 Motor Construction.</i></p>	

2-17 Over-voltage Control		
Option:	Function:	
	Overvoltage control (OVC) reduces the risk of the frequency converter tripping due to an overvoltage on the DC link caused by generative power from the load.	
[0] *	Disabled	No OVC required.
[1]	Enabled (not at stop)	Activate OVC except when using a stop signal to stop the frequency converter.
[2]	Enabled	Activate OVC.

2-17 Over-voltage Control		
Option:	Function:	
	<p>! WARNING</p> <p>PERSONAL INJURY AND EQUIPMENT DAMAGE</p> <p>Enabling OVC in hoisting applications may lead to personal injuries and equipment damage. Do not enable OVC in such applications.</p>	

2-19 Over-voltage Gain		
Range:	Function:	
100 %*	[0 - 200 %]	Select overvoltage gain.

2-20 Release Brake Current		
Range:	Function:	
0 A*	[0 - 100 A]	Set the motor current for release of the mechanical brake when a start condition is present. The upper limit is specified in <i>parameter 16-37 Inv. Max. Current</i> .
	<p>NOTICE</p> <p>When mechanical brake control output is selected, but no mechanical brake is connected, the function does not work by default setting due to too low motor current.</p>	

2-22 Activate Brake Speed [Hz]		
Range:	Function:	
0 Hz*	[0 - 400 Hz]	Set the motor frequency for activation of the mechanical brake when a stop condition is present.

2-23 Activate Brake Delay		
Range:	Function:	
0 s*	[0 - 5 s]	Enter the brake delay time of the coast after ramp-down time. The shaft is held at 0 speed with full holding torque. Ensure that the mechanical brake has locked the load before the motor enters coast mode.

4.4 Parameters: 3-** Reference/Ramps

3-00 Reference Range		
Option:	Function:	
[0] *	Min - Max	Select the range of the reference signal and the feedback signal. Signal values can be positive only, or positive and negative.
[1]	-Max - +Max	For both positive and negative values (both directions), relative to <i>parameter 4-10 Motor Speed Direction</i> .

3-01 Reference/Feedback Unit		
Option:	Function:	
		Select the unit for process PID control references and feedbacks.
[0]	None	
[1]	%	
[2]	RPM	
[3]	Hz	
[4]	Nm	
[5]	PPM	
[10]	1/min	
[12]	Pulse/s	
[20]	l/s	
[21]	l/min	
[22]	l/h	
[23]	m ³ /s	
[24]	m ³ /min	
[25]	m ³ /h	
[30]	kg/s	
[31]	kg/min	
[32]	kg/h	
[33]	t/min	
[34]	t/h	
[40]	m/s	
[41]	m/min	
[45]	m	
[60]	°C	
[70]	mbar	
[71]	bar	
[72]	Pa	
[73]	kPa	
[74]	m WG	
[80]	kW	
[120]	GPM	
[121]	gal/s	
[122]	gal/min	
[123]	gal/h	
[124]	CFM	
[125]	ft ³ /s	
[126]	ft ³ /min	
[127]	ft ³ /h	
[130]	lb/s	
[131]	lb/min	

3-01 Reference/Feedback Unit		
Option:	Function:	
[132]	lb/h	
[140]	ft/s	
[141]	ft/min	
[145]	ft	
[150]	lb ft	
[160]	°F	
[170]	psi	
[171]	lb/in ²	
[172]	in WG	
[173]	ft WG	
[180]	HP	

3-02 Minimum Reference		
Range:	Function:	
0 Reference Feedback Unit*	[0 - 4999 Reference Feedback Unit]	<p>Enter the minimum reference. The minimum reference is the lowest value obtainable by summing all references. The minimum reference is active only when <i>parameter 3-00 Reference Range</i> is set to [0] <i>Min.-Max</i>.</p> <p>The minimum reference unit matches:</p> <ul style="list-style-type: none"> The option in <i>parameter 1-00 Configuration Mode</i>. The unit selected in <i>parameter 3-01 Reference/Feedback Unit</i>.

3-03 Maximum Reference		
Range:	Function:	
Size related*	[-4999.0 - 4999 ReferenceFeed- backUnit]	<p>Enter the maximum reference. The maximum reference is the highest value obtainable by summing all references.</p> <p>The maximum reference unit matches:</p> <ul style="list-style-type: none"> The option selected in <i>parameter 1-00 Configuration Mode</i>. The unit selected in <i>parameter 3-00 Reference Range</i>.

3-04 Reference Function		
Option:	Function:	
[0] *	Sum	Sum both external and preset reference sources.
[1]	External/ Preset	Use either the preset or the external reference source. Shift between external and preset via a command or a digital input.

3-10 Preset Reference		
Range:	Function:	
0 %* [-100 - 100 %]	Enter up to 8 different preset references (0-7) in this parameter, using array programming. For selecting dedicated references, select <i>preset reference bit 0/1/2</i> [16], [17], or [18] for the corresponding digital inputs in <i>parameter group 5-1* Digital Inputs</i> .	

3-11 Jog Speed [Hz]		
Range:	Function:	
5 Hz* [0 - 500.0 Hz]	The jog speed is a fixed output speed at which the frequency converter runs when the jog function is activated. See also <i>parameter 3-80 Jog Ramp Time</i> .	

3-12 Catch up/slow Down Value		
Range:	Function:	
0 %* [0 - 100 %]	Enter a percentage value to be either added to or deducted from the actual reference for catching up or slowing down respectively. If [28] <i>Catch up</i> is selected via 1 of the digital inputs (<i>parameter 5-10 Terminal 18 Digital Input to parameter 5-15 Terminal 33 Digital Input</i>), the percentage value is added to the total reference. If [29] <i>Slow down</i> is selected via 1 of the digital inputs (<i>parameter 5-10 Terminal 18 Digital Input to parameter 5-15 Terminal 33 Digital Input</i>), the percentage value is deducted from the total reference.	

3-14 Preset Relative Reference		
Range:	Function:	
0 %* [-100 - 100 %]	The actual reference, X, is increased or decreased with the percentage Y, set in <i>parameter 3-14 Preset Relative Reference</i> . This results in the actual reference Z. Actual reference (X) is the sum of the inputs selected in <i>parameter 3-15 Reference 1 Source</i> , <i>parameter 3-16 Reference 2 Source</i> , <i>parameter 3-17 Reference 3 Source</i> , and <i>parameter 8-02 Control Source</i> .	

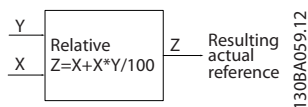

Illustration 4.3 Preset Relative Reference

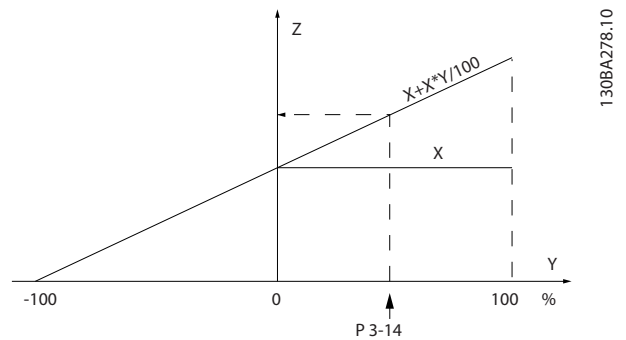

Illustration 4.4 Actual Reference

3-15 Reference 1 Source		
Option:	Function:	
	Select the reference input to be used for the first reference signal. <i>Parameter 3-15 Reference 1 Source</i> , <i>parameter 3-16 Reference 2 Source</i> , and <i>parameter 3-17 Reference 3 Source</i> define up to 3 different reference signals. The sum of these reference signals defines the actual reference.	
[0]	No function	
[1] *	Analog Input 53	
[2]	Analog Input 54	
[7]	Frequency input 29	
[8]	Frequency input 33	
[11]	Local bus reference	
[20]	Digital pot.meter	
[32]	Bus PCD	

3-16 Reference 2 Source		
Option:	Function:	
	Select the reference input to be used for the first reference signal. <i>Parameter 3-15 Reference 1 Source</i> , <i>parameter 3-16 Reference 2 Source</i> , and <i>parameter 3-17 Reference 3 Source</i> define up to 3 different reference signals. The sum of these reference signals defines the actual reference.	
[0]	No function	
[1]	Analog Input 53	
[2] *	Analog Input 54	
[7]	Frequency input 29	
[8]	Frequency input 33	
[11]	Local bus reference	

3-16 Reference 2 Source		
Option:	Function:	
[20]	Digital pot.meter	
[32]	Bus PCD	

3-17 Reference 3 Source		
Option:	Function:	
		Select the reference input to be used for the first reference signal. <i>Parameter 3-15 Reference 1 Source, parameter 3-16 Reference 2 Source, and parameter 3-17 Reference 3 Source</i> define up to 3 different reference signals. The sum of these reference signals defines the actual reference.
[0]	No function	
[1]	Analog Input 53	
[2]	Analog Input 54	
[7]	Frequency input 29	
[8]	Frequency input 33	
[11] *	Local bus reference	
[20]	Digital pot.meter	
[32]	Bus PCD	

3-18 Relative Scaling Reference Resource		
Option:	Function:	
		<p>NOTICE This parameter cannot be adjusted while the motor is running.</p> <p>Select a variable value to be added to the fixed value (defined in <i>parameter 3-14 Preset Relative Reference</i>). The sum of the fixed and variable values (labeled Y in <i>Illustration 4.5</i>) is multiplied by the actual reference (labeled X in <i>Illustration 4.5</i>). This product is then added to the actual reference (X+X*Y/100) to give the resulting actual reference.</p> <div style="text-align: center;"> </div> <p>Illustration 4.5 Resulting Actual Reference</p>
[0] *	No function	
[1]	Analog Input 53	
[2]	Analog Input 54	
[7]	Frequency input 29	

3-18 Relative Scaling Reference Resource		
Option:	Function:	
[8]	Frequency input 33	
[11]	Local bus reference	

3-40 Ramp 1 Type		
Option:	Function:	
		Select the ramp type, depending on requirements for acceleration/deceleration. A linear ramp gives constant acceleration during ramping. A sine-2 ramp gives non-linear acceleration.
[0] *	Linear	
[1]	Sine Ramp	
[2]	Sine 2 Ramp	S-ramp based on the values set in <i>parameter 3-41 Ramp 1 Ramp Up Time</i> and <i>parameter 3-42 Ramp 1 Ramp Down Time</i> .

3-41 Ramp 1 Ramp Up Time		
Range:	Function:	
Size related*	[0.01 - 3600 s]	Enter the ramp-up time, that is the acceleration time from 0 RPM to the synchronous motor speed n_s . Select a ramp-up time such that the output current does not exceed the current limit in <i>parameter 4-18 Current Limit</i> during ramping. The value 0.00 corresponds to 0.01 s in speed mode. See ramp-down time in <i>parameter 3-42 Ramp 1 Ramp Down Time</i> .
		$Par. 3 - 41 = \frac{t_{acc} [s] \times n_s [RPM]}{ref [RPM]}$

3-42 Ramp 1 Ramp Down Time		
Range:	Function:	
Size related*	[0.01 - 3600 s]	Enter the ramp-down time, that is the deceleration time from the synchronous motor speed n_s to 0 RPM. Select a ramp-down time such that no overvoltage occurs in the inverter due to regenerative operation of the motor, and such that the generated current does not exceed the current limit set in <i>parameter 4-18 Current Limit</i> . The value 0.00 corresponds to 0.01 s in speed mode. See ramp-up time in <i>parameter 3-41 Ramp 1 Ramp Up Time</i> .
		$Par. 3 - 42 = \frac{t_{dec} [s] \times n_s [RPM]}{ref [RPM]}$

3-50 Ramp 2 Type		
Option:	Function:	
		Select the ramp type, depending on requirements for acceleration/deceleration. A linear ramp gives constant acceleration during ramping. A sine-2 ramp gives non-linear acceleration.
[0] *	Linear	
[1]	Sine Ramp	
[2]	Sine 2 Ramp	S-ramp based on the values set in <i>parameter 3-51 Ramp 2 Ramp Up Time</i> and <i>parameter 3-52 Ramp 2 Ramp Down Time</i> .

3-51 Ramp 2 Ramp Up Time		
Range:	Function:	
Size related*	[0.01 - 3600 s]	Enter the ramp-up time, which is the acceleration time from 0 RPM to the rated motor speed n_s . Select a ramp-up time such that the output current does not exceed the current limit in <i>parameter 4-18 Current Limit</i> during ramping. The value 0.00 corresponds to 0.01 s in speed mode. See ramp-down time in <i>parameter 3-52 Ramp 2 Ramp Down Time</i> .
$Par. 3 - 51 = \frac{t_{dec} [s] \times n_s [RPM]}{ref [RPM]}$		

3-52 Ramp 2 Ramp Down Time		
Range:	Function:	
Size related*	[0.01 - 3600 s]	Enter the ramp-down time, that is the deceleration time from the rated motor speed n_s to 0 RPM. Select a ramp-down time such that no overvoltage arises in the frequency converter due to regenerative operation of the motor, and such that the generated current does not exceed the current limit set in <i>parameter 4-18 Current Limit</i> . The value 0.00 corresponds to 0.01 s in speed mode. See ramp-up time in <i>parameter 3-51 Ramp 2 Ramp Up Time</i> .
$Par. 3 - 52 = \frac{t_{dec} [s] \times n_s [RPM]}{ref [RPM]}$		

3-60 Ramp 3 Type		
Option:	Function:	
		Select the ramp type, depending on requirements for acceleration/deceleration. A linear ramp gives constant acceleration during ramping. An S-ramp gives non-linear acceleration.
[0] *	Linear	
[1]	Sine Ramp	

3-60 Ramp 3 Type		
Option:	Function:	
[2]	Sine 2 Ramp	S-ramp based on the values set in <i>parameter 3-61 Ramp 3 Ramp up Time</i> and <i>parameter 3-62 Ramp 3 Ramp down Time</i> .

3-61 Ramp 3 Ramp up Time		
Range:	Function:	
Size related*	[0.01 - 3600 s]	Enter the ramp-up time, which is the acceleration time from 0 RPM to the rated motor speed n_s . Select a ramp-up time such that the output current does not exceed the current limit in <i>parameter 4-18 Current Limit</i> during ramping. The value 0.00 corresponds to 0.01 s in speed mode. See ramp-down time in <i>parameter 3-62 Ramp 3 Ramp down Time</i> .

3-62 Ramp 3 Ramp down Time		
Range:	Function:	
Size related*	[0.01 - 3600 s]	Enter the ramp-down time, which is the deceleration time from the rated motor speed n_s to 0 RPM. Select a ramp-down time such that no overvoltage arises in the inverter due to regenerative operation of the motor, and such that the generated current does not exceed the current limit set in <i>parameter 4-18 Current Limit</i> . The value 0.00 corresponds to 0.01 s in speed mode. See ramp-up time in <i>parameter 3-61 Ramp 3 Ramp up Time</i> .
$Par. 3 - 62 = \frac{t_{dec} [s] \times n_s [RPM]}{ref [RPM]}$		

3-70 Ramp 4 Type		
Option:	Function:	
		Select the ramp type, depending on requirements for acceleration/deceleration. A linear ramp gives constant acceleration during ramping. An S-ramp gives non-linear acceleration.
[0] *	Linear	
[1]	Sine Ramp	
[2]	Sine 2 Ramp	S-ramp based on the values set in <i>parameter 3-71 Ramp 4 Ramp up Time</i> and <i>parameter 3-72 Ramp 4 Ramp Down Time</i> .

3-71 Ramp 4 Ramp up Time		
Range:	Function:	
Size related*	[0.01 - 3600 s]	Enter the ramp-up time, which is the acceleration time from 0 RPM to the rated motor speed n_s . Select a ramp-up time such that the output current does not exceed the current limit in <i>parameter 4-18 Current Limit</i>

3-71 Ramp 4 Ramp up Time	
Range:	Function:
	during ramping. The value 0.00 corresponds to 0.01 s in speed mode. See ramp-down time in <i>parameter 3-72 Ramp 4 Ramp Down Time</i> .
	$Par. 3 - 71 = \frac{t_{acc} [s] \times n_s [RPM]}{ref [RPM]}$

3-72 Ramp 4 Ramp Down Time	
Range:	Function:
Size related* [0.01 - 3600 s]	Enter the ramp-down time, which is the deceleration time from the rated motor speed n_s to 0 RPM. Select a ramp-down time such that no overvoltage arises in the inverter due to regenerative operation of the motor, and such that the generated current does not exceed the current limit set in <i>parameter 4-18 Current Limit</i> . The value 0.00 corresponds to 0.01 s in speed mode. See ramp-up time in <i>parameter 3-71 Ramp 4 Ramp up Time</i> .
	$Par. 3 - 72 = \frac{t_{dec} [s] \times n_s [RPM]}{ref [RPM]}$

3-80 Jog Ramp Time	
Range:	Function:
Size related* [0.01 - 3600 s]	Enter the jog ramp time, which is the acceleration/deceleration time between 0 RPM and the rated motor frequency n_s . Ensure that the resulting output current required for the given jog ramp time does not exceed the current limit in <i>parameter 4-18 Current Limit</i> . The jog ramp time starts when activating a jog signal via the LCP, a selected digital output, or the serial communication port. When jog state is disabled, the normal ramping times are valid.

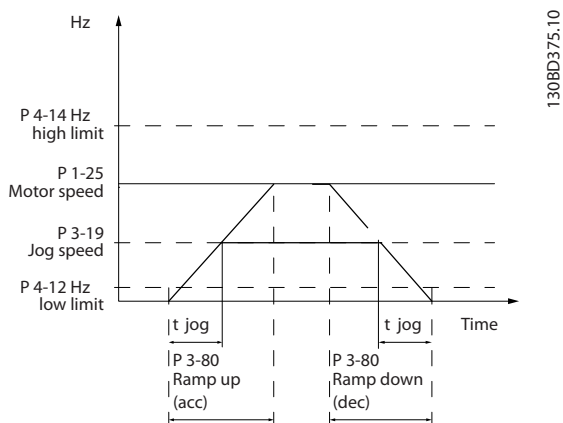

Illustration 4.6 Jog Ramp Time

$$Par. 3 - 80 = \frac{t_{jog} [s] \times n_s [RPM]}{\Delta jog\ speed (par. 3 - 19) [RPM]}$$

3-81 Quick Stop Ramp Time	
Range:	Function:
Size related* [0.01 - 3600 s]	Enter the quick-stop ramp-down time, which is the deceleration time from the synchronous motor speed to 0 RPM. Ensure that no resulting overvoltage occurs in the inverter due to regenerative operation of the motor required to achieve the given ramp-down time. Also, ensure that the generated current required to achieve the given ramp-down time does not exceed the current limit (set in <i>parameter 4-18 Current Limit</i>). Activate quick stop with a signal on a selected digital input, or via the serial communication port.

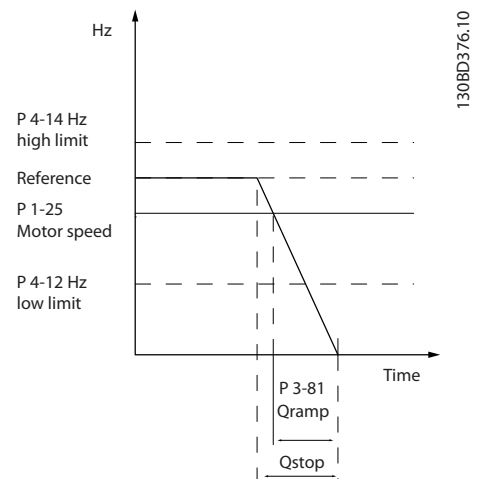

Illustration 4.7 Quick Stop Ramp Time

3-90 Step Size	
Range:	Function:
0.10 % * [0.01 - 200 %]	Enter the increment size required for increase/decrease, as a percentage of the synchronous motor speed, n_s . If increase/decrease is activated, the resulting reference is increased/decreased by the amount set in this parameter.

3-92 Power Restore	
Option:	Function:
[0] * Off	Reset the digital potentiometer reference to 0% after power-up.
[1] On	Restore the most recent digital potentiometer reference at power-up.

3-93 Maximum Limit		
Range:		Function:
100 %*	[-200 - 200 %]	Set the maximum permissible value for the resulting reference. This is recommended if the digital potentiometer is used for fine-tuning of the resulting reference.

3-94 Minimum Limit		
Range:		Function:
-100 %	[-200 - 200 %]	Set the minimum allowed value for the resulting reference. This is recommended if the digital potentiometer is used for fine-tuning of the resulting reference.

3-95 Ramp Delay		
Range:		Function:
1000 ms*	[0 - 3600000 ms]	Enter the delay required from activation of the digital potentiometer function until the frequency converter starts to ramp the reference. With a delay of 0 ms, the reference starts to ramp as soon as increase/decrease is activated.

3-96 Maximum Limit Switch Reference		
Range:		Function:
25 %*	[0 - 200 %]	Enter the maximum limit switch reference. If the crane reaches a limit switch (OFF), and if the speed exceeds the value in this parameter, then the speed is reduced automatically to the value in this parameter. If the limit switch is off, the speed cannot exceed the value in this parameter.

4.5 Parameters: 4-** Limits/Warnings

4-10 Motor Speed Direction		
Option:	Function:	
[0] * Clockwise	<p>NOTICE The setting in <i>parameter 4-10 Motor Speed Direction</i> has impact on <i>parameter 1-73 Flying Start</i>.</p> <p>Only operation in clockwise direction is allowed.</p>	
[2]	Both directions	Operation in both clockwise and counter-clockwise directions are allowed.

4-12 Motor Speed Low Limit [Hz]		
Range:	Function:	
0 Hz* [0 - 500.0 Hz]	Enter the minimum limit for motor speed. The motor speed low limit can be set to correspond to the minimum output frequency of the motor shaft. The motor speed low limit must not exceed the setting in <i>parameter 4-14 Motor Speed High Limit [Hz]</i> .	

4-14 Motor Speed High Limit [Hz]		
Range:	Function:	
65 Hz* [0.1 - 500 Hz]	<p>NOTICE Maximum output frequency cannot exceed 10% of the inverter switching frequency (<i>parameter 14-01 Switching Frequency</i>).</p> <p>Enter the maximum limit for motor speed. The motor speed high limit can be set to correspond to the manufacturer's recommended maximum of the motor shaft. The motor speed high limit must exceed the value in <i>parameter 4-12 Motor Speed Low Limit [Hz]</i>.</p>	

4-16 Torque Limit Motor Mode		
Range:	Function:	
Size related* [0 - 1000 %]	This function limits the torque on the shaft to protect the mechanical installation.	

4-17 Torque Limit Generator Mode		
Range:	Function:	
100 %* [0 - 1000 %]	This function limits the torque on the shaft to protect the mechanical installation.	

4-18 Current Limit		
Range:	Function:	
Size related* [0 - 1000 %]	This is a true current limit function that continues in the oversynchronous range. However, due to field weakening, the motor torque at current limit drops accordingly when the voltage increase stops above the synchronized motor speed.	

4-19 Max Output Frequency		
Range:	Function:	
Size related* [0 - 500 Hz]	<p>NOTICE This parameter cannot be adjusted while the motor is running.</p> <p>NOTICE Maximum output frequency cannot exceed 10% of the inverter switching frequency (<i>parameter 14-01 Switching Frequency</i>).</p> <p>Provide a final limit on the output frequency for improved safety in applications at risk of overspeeding. This limit is final in all configurations (independent of the setting in <i>parameter 1-00 Configuration Mode</i>).</p>	

4-20 Torque Limit Factor Source		
Select an analog input for scaling the settings in <i>parameter 4-16 Torque Limit Motor Mode</i> and <i>parameter 4-17 Torque Limit Generator Mode</i> 0–100% (or inverse). The signal levels corresponding to 0% and 100% are defined in the analog input scaling, for example <i>parameter group 6-1* Analog Input 1</i> . This parameter is only active when <i>parameter 1-00 Configuration Mode</i> is set to [0] Open Loop or [1] Speed Closed Loop.		
Option:	Function:	
[0] *	No function	
[2]	Analog in 53	
[4]	Analog in 53 inv	
[6]	Analog in 54	
[8]	Analog in 54 inv	

4-21 Speed Limit Factor Source		
Select an analog input for scaling the settings in <i>parameter 4-19 Max Output Frequency</i> 0–100% (or inverse). The signal levels corresponding to 0% and 100% are defined in the analog input scaling, for example <i>parameter group 6-1* Analog Input 1</i> . This parameter is only active when <i>parameter 1-00 Configuration Mode</i> is in torque mode.		
Option:	Function:	
[0] *	No function	
[2]	Analog in 53	

4-21 Speed Limit Factor Source		
Select an analog input for scaling the settings in <i>parameter 4-19 Max Output Frequency</i> 0–100% (or inverse). The signal levels corresponding to 0% and 100% are defined in the analog input scaling, for example <i>parameter group 6-1* Analog Input 1</i> . This parameter is only active when <i>parameter 1-00 Configuration Mode</i> is in torque mode.		
Option:	Function:	
[4]	Analog in 53 inv	
[6]	Analog in 54	
[8]	Analog in 54 inv	

4-22 Break Away Boost		
Option:	Function:	
[0] *	Off	
[1]	On	The frequency converter provides higher current than normal current levels to enhance breakaway-torque capacity.

4-30 Motor Feedback Loss Function		
Option:	Function:	
		This function is used to monitor consistency in the feedback signal, that is, if the feedback signal is available. Select the action of the frequency converter if a feedback fault is detected. The selected action takes place when the feedback signal differs from the output speed by the value set in <i>parameter 4-31 Motor Feedback Speed Error</i> for longer than the value set in <i>parameter 4-32 Motor Feedback Loss Timeout</i> .
[0] *	Disabled	
[1]	Warning	
[2]	Trip	
[3]	Jog	
[4]	Freeze Output	
[5]	Max Speed	
[6]	Switch to Open Loop	

4-31 Motor Feedback Speed Error		
Range:	Function:	
20 Hz*	[0 - 50 Hz]	Select the maximum allowed error in speed (output speed versus feedback).

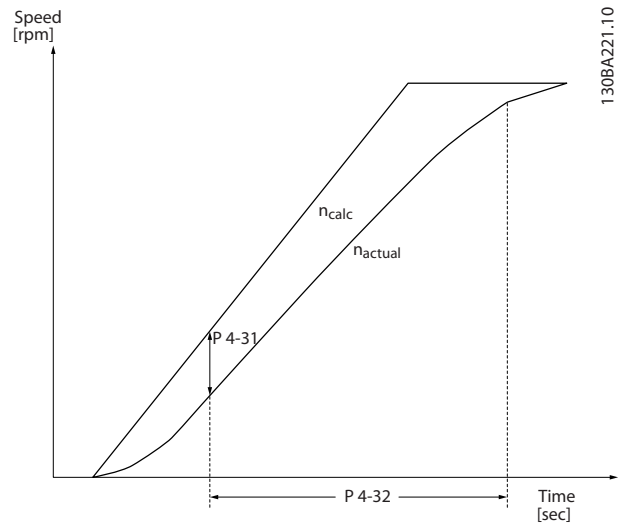

Illustration 4.8 Motor Feedback Speed Error

4-32 Motor Feedback Loss Timeout		
Range:	Function:	
0.05 s*	[0 - 60 s]	Set the timeout value allowing the speed error set in <i>parameter 4-31 Motor Feedback Speed Error</i> to be exceeded before enabling the function selected in <i>parameter 4-30 Motor Feedback Loss Function</i> .

4-40 Warning Freq. Low		
Range:	Function:	
Size related*	[0 - 500 Hz]	Use this parameter for setting a lower limit for the frequency range. When the motor speed drops below this limit, the display reads <i>Speed low</i> . Warning bit 10 is set in <i>parameter 16-94 Ext. Status Word</i> . Output relay can be configured to indicate this warning. LCP warning light is not lit when the limit set is reached.

4-41 Warning Freq. High		
Range:	Function:	
Size related*	[0 - 500 Hz]	Use this parameter for setting a higher limit for the frequency range. When the motor speed exceeds this limit, the display reads <i>Speed high</i> . Warning bit 9 is set in <i>parameter 16-94 Ext. Status Word</i> . Output relay can be configured to indicate this warning. LCP warning light is not lit when the limit set is reached.

4-42 Adjustable Temperature Warning		
Range:	Function:	
0*	[0 - 255]	Use this parameter to set the motor temperature limit.

4-50 Warning Current Low		
Range:	Function:	
0 A* [0 - 194.0 A]	Enter the I_{LOW} value. When the motor current drops below this limit, a bit in the status word is set. This value can also be programmed to produce a signal on the digital output or the relay output.	

4-51 Warning Current High		
Range:	Function:	
Size related* [0.0 - 194.0 A]	Enter the I_{HIGH} value. When the motor current exceeds this limit, a bit in the status word is set. This value can also be programmed to produce a signal on the digital output or the relay output.	

4-54 Warning Reference Low		
Range:	Function:	
-4999* [-4999 - 4999]	Enter the low reference limit. When the actual reference drops below this limit, the display shows <i>Ref_{LOW}</i> . Bit 20 is set in <i>parameter 16-94 Ext. Status Word</i> . The output relay or the digital output can be configured to indicate this warning. The LCP warning light is not turned on when this parameter set limit is reached.	

4-55 Warning Reference High		
Range:	Function:	
4999* [-4999 - 4999]	Use this parameter to set a high limit for the reference range. When the actual reference exceeds this limit, the display shows <i>Ref_{HIGH}</i> . Bit 19 is set in <i>parameter 16-94 Ext. Status Word</i> . The output relay or the digital output can be configured to indicate this warning. The LCP warning light is not turned on when this parameter set limit is reached.	

4-56 Warning Feedback Low		
Range:	Function:	
-4999 ProcessCtrlUnit*	[-4999 - 4999 ProcessCtrlUnit]	Use this parameter to set a low limit for the feedback range. When the feedback drops below this limit, the display shows <i>Feedb Low</i> . Bit 6 is set in <i>parameter 16-94 Ext. Status Word</i> . The output relay or the digital output can be configured to indicate this warning. The LCP warning light is not turned on when this parameter set limit is reached.

4-57 Warning Feedback High		
Range:	Function:	
4999 ProcessCtrlUnit*	[-4999 - 4999 ProcessCtrlUnit]	Use this parameter to set a high limit for the feedback range. When the feedback exceeds this limit, the display reads <i>Feedb High</i> . Bit 5 is set in <i>parameter 16-94 Ext. Status Word</i> . The output relay or the digital output can be configured to indicate this warning. The LCP warning light is not turned on when this parameter set limit is reached.

4-58 Missing Motor Phase Function		
Option:	Function:	
[0]	Off	No alarm is shown if a missing motor phase occurs.
[1] *	On	An alarm is shown if a missing motor phase occurs.

4-61 Bypass Speed From [Hz]		
Range:	Function:	
0 Hz* [0 - 500 Hz]	Some systems call for avoiding certain output speeds due to resonance problems in the system. Enter the lower limits of the speeds to be avoided.	

4-63 Bypass Speed To [Hz]		
Range:	Function:	
0 Hz* [0 - 500 Hz]	Some systems call for avoiding certain output speeds due to resonance problems in the system. Enter the upper limits of the speeds to be avoided.	

4-64 Semi-Auto Bypass Set-up		
Option:	Function:	
[0] *	Off	
[1]	Enable	

4.6 Parameters: 5-** Digital In/Out

5-00 Digital Input Mode		
Option:	Function:	
		Set NPN or PNP mode for digital inputs 18, 19, 27, 29, 32, and 33. Digital input mode.
[0] *	PNP	Action on positive directional pulses (0). PNP systems are pulled down to ground (GND).
[1]	NPN	Action on negative directional pulses (1). NPN systems are pulled up to +24 V, internally in the frequency converter.

5-01 Terminal 27 Mode		
Option:	Function:	
		NOTICE This parameter cannot be adjusted while the motor is running.
[0] *	Input	Define terminal 27 as a digital input.
[1]	Output	Define terminal 27 as a digital output.

4.6.1 5-1* Digital Inputs

The digital inputs are used for selecting various functions in the frequency converter.

5-10 to 5-15 Digital Inputs

[0]	No operation	No reaction to signals transmitted to the terminal.
[1]	Reset	Resets frequency converter after a trip/alarm. Not all alarms can be reset.
[2]	Coast inverse	(Default Digital input 27): Coasting stop, inverted input (NC). The frequency converter leaves the motor in free mode. Logic 0⇒coasting stop.
[3]	Coast and reset inverse	Reset and coasting stop inverted input (NC). Leaves motor in free mode and resets frequency converter. Logic 0⇒coasting stop and reset.
[4]	Quick stop inverse	Inverted input (NC). Generates a stop in accordance with the quick stop ramp time set in <i>parameter 3-81 Quick Stop Ramp Time</i> . When the motor stops, the shaft is in free mode. Logic 0⇒Quick-stop.
[5]	DC-brake inverse	Inverted input for DC braking (NC). Stops the motor by energizing it with a DC current for a certain time period. See <i>parameter 2-01 DC Brake Current</i> to <i>parameter 2-04 DC Brake Cut In Speed [Hz]</i> . The function is only active when the value in <i>parameter 2-02 DC Braking Time</i> is different from 0. Logic 0⇒DC braking.

[6]	Stop inverse	NOTICE When the frequency converter is at the torque limit and has received a stop command, it may not stop by itself. To ensure that the frequency converter stops, configure a digital output to [27] <i>Torque limit and stop</i> and connect this digital output to a digital input that is configured as coast. Stop inverted function. Generates a stop function when the selected terminal goes from logic 1 to logic 0. The stop is performed according to the selected ramp time (<i>parameter 3-42 Ramp 1 Ramp Down Time</i> , <i>parameter 3-52 Ramp 2 Ramp Down Time</i> , <i>parameter 3-62 Ramp 3 Ramp down Time</i> , <i>parameter 3-72 Ramp 4 Ramp Down Time</i>).
[8]	Start	Default digital input 18. Select start for a start/stop command. Logic 1=start, logic 0=stop.
[9]	Latched start	The motor starts when a pulse is applied for minimum 2 ms. The motor stops when [6] <i>Stop inverse</i> is activated or a reset command (via DI) is given.
[10]	Reversing	Default digital input 19. Change the direction of motor shaft rotation. Select logic 1 to reverse. The reversing signal only changes the direction of rotation. It does not activate the start function. Select both directions in <i>parameter 4-10 Motor Speed Direction</i> . The function is not active in process closed loop.
[11]	Start reversing	Used for start/stop and for reversing on the same wire. Signals on start are not allowed at the same time.
[12]	Enable start forward	Disengage the counterclockwise movement and allows for the clockwise direction.
[13]	Enable start reverse	Disengage the clockwise movement and allows for the counterclockwise direction.
[14]	Jog	Default digital input 29. Use to activate jog speed. See <i>parameter 3-11 Jog Speed [Hz]</i> .
[15]	Preset reference on	Shift between external reference and preset reference. It is assumed that [1] <i>External/preset</i> has been selected in <i>parameter 3-04 Reference Function</i> . Logic 0 = external reference active; logic 1=1 of the 8 preset references is active.
[16]	Preset ref bit 0	Preset reference bits 0, 1, and 2 enable the selection of 1 of the 8 preset references according to <i>Table 4.1</i> .
[17]	Preset ref bit 1	Same as [16] <i>Preset ref bit 0</i> .
[18]	Preset ref bit 2	Same as [16] <i>Preset ref bit 0</i> .

Preset ref. bit	2	1	0
Preset ref. 0	0	0	0
Preset ref. 1	0	0	1
Preset ref. 2	0	1	0
Preset ref. 3	0	1	1
Preset ref. 4	1	0	0
Preset ref. 5	1	0	1
Preset ref. 6	1	1	0
Preset ref. 7	1	1	1

Table 4.1 Preset Ref. Bit

[19]	Freeze ref	Freeze the actual reference, which is now the point of enable/condition for [21] Speed up and [22] Speed down to be used. If [21] Speed up or [22] Speed down is used, the speed change always follows ramp 2 (parameter 3-51 Ramp 2 Ramp Up Time and parameter 3-52 Ramp 2 Ramp Down Time) in the range 0-parameter 3-03 Maximum Reference.
[20]	Freeze output	<p>NOTICE</p> <p>When [20] Freeze output is active, the frequency converter cannot be stopped by setting the signal on [8] Start to low. Stop the frequency converter via a terminal programmed for [2] Coasting inverse or [3] Coast and reset, inverse.</p> <p>Freeze the actual motor frequency (Hz), which is now the point of enable/condition for [21] Speed up and [22] Speed down to be used. If [21] Speed up or [22] Speed down is used, the speed change always follows ramp 2 (parameter 3-51 Ramp 2 Ramp Up Time and parameter 3-52 Ramp 2 Ramp Down Time) in the range 0-parameter 1-23 Motor Frequency.</p>
[21]	Speed up	Select [21] Speed up and [22] Speed down if digital control of the up/down speed is needed (motor potentiometer). Activate this function by selecting either [19] Freeze reference or [20] Freeze output. When speed up/down is activated for less than 400 ms, the resulting reference is increased/decreased by 0.1%. If speed up/down is activated for more than 400 ms, the resulting reference follows the setting in ramping up/down parameter 3-x1/3-x2.

	Shut down	Catch up
Unchanged speed	0	0
Reduced by %-value	1	0
Increased by %-value	0	1
Reduced by %-value	1	1

Table 4.2 Shut Down/Catch Up

[22]	Speed down	Same as [21] Speed up.
[23]	Set-up select bit 0	Select [23] Set-up select bit 0 or [1] Set-up select bit 1 to select 1 of the 2 set-ups. Set parameter 0-10 Active Set-up to [9] Multi Set-up.

[24]	Set-up select bit 1	Default digital input 32. Same as [23] Set-up select bit 0.
[26]	Precise stop inv.	Precise stop inverse function is available for terminals 18 or 19.
[27]	Precise start stop	
[28]	Catch up	Increase reference value by percentage (relative) set in parameter 3-12 Catch up/slow Down Value.
[29]	Slow down	Reduce reference value by percentage (relative) set in parameter 3-12 Catch up/slow Down Value.
[32]	Pulse time-based	<p>Measure the duration between pulse flanks. This parameter has a higher resolution at lower frequencies, but is not as precise at higher frequencies. This principle has a cut-off frequency, which makes it unsuited for encoders with low resolutions (for example 30 PPR) at low speeds.</p> <div style="border: 1px solid black; padding: 5px;"> <p>a: Low encoder resolution b: Standard encoder resolution</p> <p>130BB462.10</p> <p>130BB464.10</p> </div> <p>Illustration 4.9 Duration Between Pulse Flanks</p>
[34]	Ramp bit 0	Enable a selection from the 4 ramps available, according to Table 4.3.
[35]	Ramp bit 1	Same as ramp bit 0.

Preset ramp bit	1	0
Ramp 1	0	0
Ramp 2	0	1
Ramp 3	1	0
Ramp 4	1	1

Table 4.3 Preset Ramp Bits

[40]	Latched precise start	A latched precise start only requires a pulse of 3 ms on terminals 18 or 19 when using parameter 1-83 Precise Stop Function [1] Counter stop with resetor [2] Counter stop without reset. When the reference is reached, the frequency converter internally enables the precise stop signal. This means that the frequency converter does the precise stop when the counter value of parameter 1-84 Precise Stop Counter Value is reached.
------	-----------------------	--

[41]	Latch prec stop inv	Send a latched stop signal when the precise stop function is activated in <i>parameter 1-83 Precise Stop Function</i> . The latched precise stop inverse function is available for terminals 18 or 19.
[51]	External interlock	This function makes it possible to give an external fault to the frequency converter. This fault is treated as an internally generated alarm.
[58]	DigiPot Hoist	
[60]	Counter A	(Terminal 29 or 33 only) Input for increment counting in the SLC counter.
[61]	Counter A	(Terminal 29 or 33 only) Input for decrement counting in the SLC counter.
[62]	Reset Counter A	Input for reset of counter A.
[63]	Counter B	(Terminal 29 or 33 only) Input for increment counting in the SLC counter.
[64]	Counter B	(Terminal 29 or 33 only) Input for decrement counting in the SLC counter.
[65]	Reset Counter B	Input for reset of counter B.
[72]	PID error inverse	Invert the resulting error from the process PID controller. Available only if <i>parameter 1-00 Configuration Mode</i> is set to [6] <i>Surface Winder</i> or [7] <i>Extended PID Speed OL</i> .
[73]	PID reset I-part	Reset the I-part of the process PID controller. Equivalent to <i>parameter 7-40 Process PID I-part Reset</i> . Available only when <i>parameter 1-00 Configuration Mode</i> is set to [6] <i>Surface Winder</i> or [7] <i>Extended PID Speed OL</i> .
[74]	PID enable	This option enables the extended process PID controller. Equivalent to <i>parameter 7-50 Process PID Extended PID</i> . Available only if <i>parameter 1-00 Configuration Mode</i> is set to [7] <i>Extended PID Speed OL</i> .
[150]	Go To Home	The frequency converter moves to the home position.
[151]	Home Ref. Switch	Indicate the status of the home referenced switch. <i>On</i> means that the home position is reached, <i>off</i> means that the home position is not reached.
[155]	HW Limit Positive	The positive hardware position limit is exceeded. This option is active on the falling edge.
[156]	HW Limit Negative	The negative hardware position limit is exceeded. This option is active on the falling edge.
[157]	Pos. Quick Stop Inv	Stop the frequency converter during positioning with the ramp time that is set in <i>parameter 32-81 Motion Ctrl Quick Stop Ramp</i> . This option is only effective when <i>parameter 37-00 Application Mode</i> is set to [2] <i>Position Control</i> .
[160]	Go To Target Pos.	The frequency converter moves to the target position. This option is only effective when

		<i>parameter 37-00 Application Mode</i> is set to [2] <i>Position Control</i> .
[162]	Pos. Idx Bit0	Position index bit 0. This option is only effective when <i>parameter 37-00 Application Mode</i> is set to [2] <i>Position Control</i> .
[163]	Pos. Idx Bit1	Position index bit 1. This option is only effective when <i>parameter 37-00 Application Mode</i> is set to [2] <i>Position Control</i> .
[164]	Pos. Idx Bit2	Position index bit 2. This option is only effective when <i>parameter 37-00 Application Mode</i> is set to [2] <i>Position Control</i> .
[171]	Limit switch cw inverse	
[172]	Limit switch ccw inverse	

5-10 Terminal 18 Digital Input

Option: **Function:**

[8] *	Start	Functions are described in <i>parameter group 5-1* Digital Inputs</i> .
-------	-------	---

5-11 Terminal 19 Digital Input

Option: **Function:**

[10] *	Reversing	Functions are described in <i>parameter group 5-1* Digital Inputs</i> .
--------	-----------	---

5-12 Terminal 27 Digital Input

Option: **Function:**

[2] *	Coast inverse	Functions are described in <i>parameter group 5-1* Digital Inputs</i> .
-------	---------------	---

5-13 Terminal 29 Digital Input

Option: **Function:**

[14] *	Jog	Functions are described in <i>parameter group 5-1* Digital Inputs</i> .
[32]	Pulse time based	

5-14 Terminal 32 Digital Input

Option: **Function:**

[0] *	No operation	Functions are described in <i>parameter group 5-1* Digital Inputs</i> .
[82]	Encoder input B	

5-15 Terminal 33 Digital Input

Option: **Function:**

[0] *	No operation	Functions are described in <i>parameter group 5-1* Digital Inputs</i> .
[32]	Pulse time based	
[81]	Encoder input A	

5-19 Terminal 37/38 Safe Torque Off		
Use this parameter to set up the STO functionality. Warning makes the frequency converter coast and enables automatic restart. Alarm makes the frequency converter coast and requires a manual restart.		
Option:	Function:	
[1] * Safe Torque Off Alarm	Coast the frequency converter when Safe Torque Off is activated. Manual reset from LCP, digital input, or fieldbus. This alarm can no longer be reset by automatic reset mode of <i>parameter 14-20 Reset Mode</i> in software 1.2 and further versions.	
[3] Safe Torque Off Warning	Coast the frequency converter when Safe Torque Off is activated (terminal 37 and terminal 38 off). When Safe Torque Off circuit is reestablished, the frequency converter continues without manual reset.	

4.6.2 5-3* Digital Outputs

The 2 solid-state digital outputs are common for terminal 27. Set the I/O function for terminal 27 in *parameter 5-01 Terminal 27 Mode*.

Terminal 42 can also be configured as digital outputs.

NOTICE

These parameters cannot be adjusted while the motor is running.

5-30 Digital Outputs

[0] *	No operation	Default for all digital outputs.
[1]	Control ready	The control card is ready.
[2]	Drive ready	The frequency converter is ready for operation and applies a supply signal on the control board.
[3]	Drive ready / remote control	The frequency converter is ready for operation and is in auto-on mode.
[4]	Stand-by / no warning	Ready for operation. No start or stop command is given (start/disable). No warnings are active.
[5]	Running	The motor is running and shaft torque is present.
[6]	Running / no warning	The output speed is higher than the speed set in <i>parameter 1-81 Min Speed for Function at Stop [RPM]</i> . The motor is running and there are no warnings.
[7]	Run in range / no warning	The motor is running within the programmed current and speed ranges set in <i>parameter 4-50 Warning Current Low</i> to <i>parameter 4-51 Warning Current High</i> . There are no warnings.

[8]	Run on reference / no warning	The motor runs at reference speed. No warnings.
[9]	Alarm	An alarm activates the output. There are no warnings.
[10]	Alarm or warning	An alarm or a warning activates the output.
[11]	At torque limit	The torque limit set in <i>parameter 4-16 Torque Limit Motor Mode</i> or <i>parameter 4-17 Torque Limit Generator Mode</i> has been exceeded.
[12]	Out of current range	The motor current is outside the range set in <i>parameter 4-18 Current Limit</i> .
[13]	Below current, low	The motor current is lower than set in <i>parameter 4-50 Warning Current Low</i> .
[14]	Above current, high	The motor current is higher than set in <i>parameter 4-51 Warning Current High</i> .
[15]	Out of frequency range	Output frequency is outside the frequency range.
[16]	Below frequency, low	The output speed is lower than the setting in <i>parameter 4-40 Warning Freq. Low</i> .
[17]	Above frequency, high	The output speed is higher than the setting in <i>parameter 4-41 Warning Freq. High</i> .
[18]	Out of feedback range	The feedback is outside the range set in <i>parameter 4-56 Warning Feedback Low</i> and <i>parameter 4-57 Warning Feedback High</i> .
[19]	Below feedback low	The feedback is below the limit set in <i>parameter 4-56 Warning Feedback Low</i> .
[20]	Above feedback high	The feedback is above the limit set in <i>parameter 4-57 Warning Feedback High</i> .
[21]	Thermal warning	The thermal warning turns on when the temperature exceeds the limit in the motor, the frequency converter, the brake resistor, or the thermistor.
[22]	Ready, no thermal warning	The frequency converter is ready for operation, and there is no overtemperature warning.
[23]	Remote, ready, no thermal warning	The frequency converter is ready for operation and is in auto-on mode. There is no overtemperature warning.
[24]	Ready, no overvoltage/ undervoltage	The frequency converter is ready for operation and the mains voltage is within the specified voltage range (see chapter <i>General Specifications</i> in the <i>design guide</i>).
[25]	Reverse	The motor runs (or is ready to run) clockwise when logic=0 and counter-clockwise when logic=1. The output changes when the reversing signal is applied.
[26]	Bus OK	Active communication (no timeout) via the serial communication port.

[27]	Torque limit and stop	Use in performing a coast stop and in torque limit condition. If the frequency converter has received a stop signal and is at the torque limit, the signal is logic 0.
[28]	Brake, no brake warning	The brake is active and there are no warnings.
[29]	Brake ready, no fault	The brake is ready for operation and there are no faults.
[30]	Brake fault (IGBT)	The output is logic 1 when the brake IGBT is short-circuited. Use this function to protect the frequency converter if there is a fault on the brake modules. Use the output/relay to cut out the mains voltage from the frequency converter.
[31]	Relay 123	The relay is activated when [0] Control Word is selected in <i>parameter group 8-** Communications and Options</i> .
[32]	Mechanical brake control	Enable control of an external mechanical brake. See <i>parameter group 2-2* Mechanical Brake</i> for more details.
[36]	Control word bit 11	
[37]	Control word bit 12	
[40]	Out of ref range	This option is active when the actual speed is outside the settings in <i>parameter 4-52 Warning Speed Low</i> to <i>parameter 4-55 Warning Reference High</i> .
[41]	Below reference low	This option is active when the actual speed is below the speed reference setting.
[42]	Above reference high	This option is active when the actual speed is above the speed reference setting.
[43]	Extended PID Limit	
[45]	Bus Ctrl	Control output via fieldbus. The state of the output is set in <i>parameter 5-90 Digital & Relay Bus Control</i> . The output state is retained in the event of fieldbus timeout.
[46]	Bus control, timeout: On	Control output via fieldbus. The state of the output is set in <i>parameter 5-90 Digital & Relay Bus Control</i> . When bus timeout occurs, the output state is set high (On).
[47]	Bus control, timeout: Off	
[55]	Pulse output	
[56]	Heat sink cleaning warning, high	
[60]	Comparator 0	See <i>parameter group 13-1* Comparators</i> . If comparator 0 is evaluated as true, the output goes high. Otherwise, it is low.
[61]	Comparator 1	See <i>parameter group 13-1* Comparators</i> . If comparator 1 is evaluated as true, the output goes high. Otherwise, it is low.

[62]	Comparator 2	See <i>parameter group 13-1* Comparators</i> . If comparator 2 is evaluated as true, the output goes high. Otherwise, it is low.
[63]	Comparator 3	See <i>parameter group 13-1* Comparators</i> . If comparator 3 is evaluated as true, the output goes high. Otherwise, it is low.
[64]	Comparator 4	See <i>parameter group 13-1* Comparators</i> . If comparator 4 is evaluated as true, the output goes high. Otherwise, it is low.
[65]	Comparator 5	See <i>parameter group 13-1* Comparators</i> . If comparator 5 is evaluated as true, the output goes high. Otherwise, it is low.
[70]	Logic Rule 0	See <i>parameter group 13-4* Logic Rules</i> . If logic rule 0 is evaluated as true, the output goes high. Otherwise, it is low.
[71]	Logic Rule 1	See <i>parameter group 13-4* Logic Rules</i> . If logic rule 1 is evaluated as true, the output goes high. Otherwise, it is low.
[72]	Logic Rule 2	See <i>parameter group 13-4* Logic Rules</i> . If logic rule 2 is evaluated as true, the output goes high. Otherwise, it is low.
[73]	Logic Rule 3	See <i>parameter group 13-4* Logic Rules</i> . If logic rule 3 is evaluated as true, the output goes high. Otherwise, it is low.
[74]	Logic Rule 4	See <i>parameter group 13-4* Logic Rules</i> . If logic rule 4 is evaluated as true, the output goes high. Otherwise, it is low.
[75]	Logic Rule 5	See <i>parameter group 13-4* Logic Rules</i> . If logic rule 5 is evaluated as true, the output goes high. Otherwise, it is low.
[80]	SL Digital Output A	See <i>parameter 13-52 SL Controller Action</i> . The output goes high whenever the smart logic action [38] Set dig. out. A high is executed. The output goes low whenever the smart logic action [32] Set dig. out. A low is executed.
[81]	SL Digital Output B	See <i>parameter 13-52 SL Controller Action</i> . The input goes high whenever the smart logic action [39] Set dig. out. B high is executed. The input goes low whenever the smart logic action [33] Set dig. out. B low is executed.
[82]	SL Digital Output C	See <i>parameter 13-52 SL Controller Action</i> . The input goes high whenever the smart logic action [40] Set dig. out. C high is executed. The input goes low whenever the smart logic action [34] Set dig. out. C low is executed.
[83]	SL Digital Output D	See <i>parameter 13-52 SL Controller Action</i> . The input goes high whenever the smart logic action [41] Set dig. out. D high is executed. The input goes low whenever the smart logic action [35] Set dig. out. D low is executed.
[91]	Encoder emulate output A	

[160]	No alarm	The output is high when no alarm is present.
[161]	Running reverse	The output is high when the frequency converter is running counterclockwise (the logical product of the status bits <i>Running AND Reverse</i>).
[165]	Local reference active	
[166]	Remote ref active	
[167]	Start command active	The output is high when there is an active start command, and no stop command is active.
[168]	Drive in hand mode	The output is high when the frequency converter is in hand-on mode.
[169]	Drive in auto mode	The output is high when the frequency converter is in auto-on mode.
[170]	Homing Completed	The homing operation is completed. This option is only effective when <i>parameter 37-00 Application Mode</i> is set to [2] <i>Position Control</i> .
[171]	Target Position Reached	The target position is reached. This option is only effective when <i>parameter 37-00 Application Mode</i> is set to [2] <i>Position Control</i> .
[172]	Position Control Fault	A fault occurred in the positioning process. Refer to <i>parameter 37-18 Pos. Ctrl Fault Reason</i> for details about the fault. This option is only effective when <i>parameter 37-00 Application Mode</i> is set to [2] <i>Position Control</i> .
[173]	Position Mech Brake	Select mechanical control for positioning. This option is only effective when <i>parameter 37-00 Application Mode</i> is set to [2] <i>Position Control</i> .
[190]	STO function active	
[193]	Sleep mode	The frequency converter/system has entered sleep mode. See <i>parameter group 22-4* Sleep Mode</i> .
[194]	Broken belt	A broken-belt condition has been detected. See <i>parameter group 22-4* Sleep Mode</i> .
[239]	STO function fault	

5-34 On Delay, Digital Output		
Range:	Function:	
0.01 s*	[0 - 600 s]	

5-35 Off Delay, Digital Output		
Range:	Function:	
0.01 s*	[0 - 600 s]	

4.6.3 5-4* Relay

Parameters for configuring the timing and the output functions for the relay.

The parameter shows 1 relay.

5-40 Function Relay

Option:	Function:
[0]	No operation Default setting for all digital outputs.
[1] *	Control Ready The control card is ready.
[2]	Drive ready The frequency converter is ready to operate. Mains and control supplies are OK.
[3]	Drive rdy/rem ctrl The frequency converter is ready for operation, and in auto-on mode.
[4]	Stand-by / no warning Ready for operation. No start or stop commands have been applied. No warnings are active.
[5]	Running The motor runs, and a shaft torque is present.
[6]	Running / no warning The output speed is higher than the speed set in <i>parameter 1-82 Min Speed for Function at Stop [Hz]</i> . The motor is running and no warnings are present.
[7]	Run in range/no warn The motor runs within the programmed current ranges set in <i>parameter 4-50 Warning Current Low</i> .
[8]	Run on ref/no warn The motor runs at reference speed. No warnings.
[9]	Alarm An alarm activates the output. No warnings.
[10]	Alarm or warning An alarm or warning activates the output.
[11]	At torque limit The torque limit set in <i>parameter 4-16 Torque Limit Motor Mode</i> or <i>parameter 4-17 Torque Limit Generator Mode</i> has been exceeded.
[12]	Out of current range The motor current is outside the range set in <i>parameter 4-18 Current Limit</i> .
[13]	Below current, low The motor current is lower than set in <i>parameter 4-50 Warning Current Low</i> .
[14]	Above current, high The motor current is higher than set in <i>parameter 4-51 Warning Current High</i> .
[15]	Out of frequency range The output speed/frequency exceeds the limit that is set in <i>parameter 4-40 Warning Freq. Low</i> and <i>parameter 4-41 Warning Freq. High</i> .
[16]	Below frequency, low The output frequency is lower than the setting in <i>parameter 4-40 Warning Freq. Low</i> .
[17]	Above frequency, high The frequency is higher than the setting in <i>parameter 4-41 Warning Freq. High</i> .
[18]	Out of feedb. range The feedback is outside the range set in <i>parameter 4-56 Warning Feedback</i>

5-40 Function Relay		
Option:	Function:	
		Low and parameter 4-57 Warning Feedback High.
[19]	Below feedback, low	The feedback is below the limit set in parameter 4-56 Warning Feedback Low.
[20]	Above feedback, high	The feedback is above the limit set in parameter 4-57 Warning Feedback High.
[21]	Thermal warning	Thermal warning turns on when the temperature exceeds the limit within the motor, frequency converter, brake resistor, or connected resistor.
[22]	Ready, no thermal warning	The frequency converter is ready for operation, and there is no overtemperature warning.
[23]	Remote,ready,no TW	The frequency converter is ready for operation and is in auto-on mode. There is no overtemperature warning.
[24]	Ready, no over-/under voltage	The frequency converter is ready for operation, and the mains voltage is within the specified voltage range.
[25]	Reverse	The motor runs (or is ready to run) clockwise when logic=0 and counter-clockwise when logic=1. The output changes when the reversing signal is applied.
[26]	Bus OK	Active communication (no timeout) via the serial communication port.
[27]	Torque limit & stop	Use for performing a coasted stop for frequency converter in torque limit condition. If the frequency converter has received a stop signal and is in torque limit, the signal is logic=0.
[28]	Brake, no brake warning	The brake is active, and there are no warnings.
[29]	Brake ready, no fault	The brake is ready for operation, and there are no faults.
[30]	Brake fault (IGBT)	The output is logic=1 when the brake IGBT is short-circuited. Use this function to protect the frequency converter if there is a fault on the brake module. Use the digital output/relay to cut out the mains voltage from the frequency converter.
[31]	Relay 123	Digital output/relay is activated when [0] Control word is selected in parameter group 8-** Comm. and Options.
[32]	Mech brake ctrl	Selection of mechanical brake control. When the parameters selected in parameter group 2-2* Mechanical Brake are active, reinforce the output to carry the current for the coil in the brake. This issue is solved by connecting an external relay to the selected digital output.

5-40 Function Relay		
Option:	Function:	
[36]	Control word bit 11	Activate relay 1 by a control word from the fieldbus. No other functional impact on the frequency converter. Typical application: Controlling an auxiliary device from a fieldbus. The function is valid when [0] FC Profile is selected in parameter 8-10 Control Word Profile.
[37]	Control word bit 12	Activate relay 2 by a control word from the fieldbus. No other functional impact on the frequency converter. Typical application: Controlling an auxiliary device from a fieldbus. The function is valid when [0] FC Profile is selected in parameter 8-10 Control Word Profile.
[40]	Out of ref range	Active when the actual speed is outside the settings in parameter 4-55 Warning Reference High and parameter 4-56 Warning Feedback Low.
[41]	Below reference, low	Active when the actual speed is below the speed reference setting.
[42]	Above ref, high	Active when the actual speed is above the speed reference setting.
[45]	Bus ctrl.	Control the digital output/relay via bus. The state of the output is set in parameter 5-90 Digital & Relay Bus Control. The output state is retained in the event of a bus timeout.
[46]	Bus control, timeout: On	Control output via bus. The state of the output is set in parameter 5-90 Digital & Relay Bus Control. When a bus timeout occurs, the output state is set high (on).
[47]	Bus control, timeout: Off	Control output via bus. The state of the output is set in parameter 5-90 Digital & Relay Bus Control. When a bus timeout occurs, the output state is set low (off).
[56]	Heat sink cleaning warning, high	
[60]	Comparator 0	See parameter group 13-1* Smart Logic Control. If comparator 0 in SLC is true, the output goes high. Otherwise, it goes low.
[61]	Comparator 1	See parameter group 13-1* Smart Logic Control. If comparator 1 in SLC is true, the output goes high. Otherwise, it goes low.
[62]	Comparator 2	See parameter group 13-1* Smart Logic Control. If comparator 2 in SLC is true, the output goes high. Otherwise, it goes low.

5-40 Function Relay		
Option:	Function:	
[63]	Comparator 3	See <i>parameter group 13-1* Smart Logic Control</i> . If comparator 3 in SLC is true, the output goes high. Otherwise, it goes low.
[64]	Comparator 4	See <i>parameter group 13-1* Smart Logic Control</i> . If comparator 4 in SLC is true, the output goes high. Otherwise, it goes low.
[65]	Comparator 5	See <i>parameter group 13-1* Smart Logic Control</i> . If comparator 5 in SLC is true, the output goes high. Otherwise, it goes low.
[70]	Logic rule 0	See <i>parameter group 13-4* Logic Rules</i> . If logic rule 0 in SLC is true, the output goes high. Otherwise, it goes low.
[71]	Logic rule 1	See <i>parameter group 13-4* Logic Rules</i> . If logic rule 1 in SLC is true, the output goes high. Otherwise, it goes low.
[72]	Logic rule 2	See <i>parameter group 13-4* Logic Rules</i> . If logic rule 2 in SLC is true, the output goes high. Otherwise, it goes low.
[73]	Logic rule 3	See <i>parameter group 13-4* Logic Rules</i> . If logic rule 3 in SLC is true, the output goes high. Otherwise, it goes low.
[74]	Logic rule 4	See <i>parameter group 13-4* Logic Rules</i> . If logic rule 4 in SLC is true, the output goes high. Otherwise, it goes low.
[75]	Logic rule 5	See <i>parameter group 13-4* Logic Rules</i> . If logic rule 5 in SLC is true, the output goes high. Otherwise, it goes low.
[80]	SL digital output A	See <i>parameter 13-52 SL Controller Action</i> . Output A is low on [32] <i>Smart Logic Action</i> . Output A is high on [38] <i>Smart Logic Action</i> .
[81]	SL digital output B	See <i>parameter 13-52 SL Controller Action</i> . Output B is low on [32] <i>Smart Logic Action</i> . Output B is high on [38] <i>Smart Logic Action</i> .
[82]	SL digital output C	See <i>parameter 13-52 SL Controller Action</i> . Output C is low on [32] <i>Smart Logic Action</i> . Output C is high on [38] <i>Smart Logic Action</i> .
[83]	SL digital output D	See <i>parameter 13-52 SL Controller Action</i> . Output D is low on [32] <i>Smart Logic Action</i> . Output D is high on [38] <i>Smart Logic Action</i> .
[160]	No alarm	The output is high when no alarm is present.
[161]	Running reverse	The output is high when the frequency converter is running counterclockwise (the logical product of the status bits <i>Running AND Reverse</i>).
[165]	Local ref active	
[166]	Remote ref active	

5-40 Function Relay		
Option:	Function:	
[167]	Start command activ	The output is high when there is an active start command, and no stop command is active.
[168]	Drive in hand mode	The output is high when the frequency converter is in hand-on mode.
[169]	Drive in auto mode	The output is high when the frequency converter is in auto-on mode.
[170]	Homing Completed	The homing operation is completed. This option is only effective when <i>parameter 37-00 Application Mode</i> is set to [2] <i>Position Control</i> .
[171]	Target Position Reached	The target position is reached. This option is only effective when <i>parameter 37-00 Application Mode</i> is set to [2] <i>Position Control</i> .
[172]	Position Control Fault	A fault occurred in the positioning process. Refer to <i>parameter 37-18 Pos. Ctrl Fault Reason</i> for details about the fault. This option is only effective when <i>parameter 37-00 Application Mode</i> is set to [2] <i>Position Control</i> .
[173]	Position Mech Brake	Select mechanical control for positioning. This option is only effective when <i>parameter 37-00 Application Mode</i> is set to [2] <i>Position Control</i> .
[190]	STO function active	
[193]	Sleep Mode	The frequency converter/system has entered sleep mode. See <i>parameter group 22-4* Sleep Mode</i> .
[194]	Broken Belt Function	A broken-belt condition has been detected. See <i>parameter group 22-4* Sleep Mode</i> .
[239]	STO Function Fault	

5-41 On Delay, Relay		
Range:	Function:	
0.01 s*	[0.01 - 600 s]	Enter the delay of the relay cut-in time. The relay only cuts in if the condition in <i>parameter 5-40 Function Relay</i> is uninterrupted during the specified time.

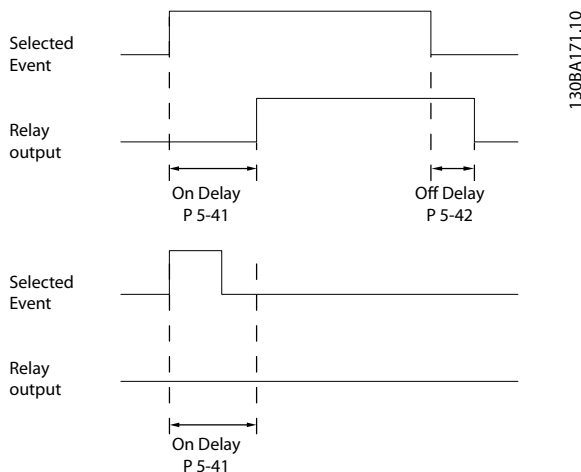

Illustration 4.10 On Delay, Relay

5-42 Off Delay, Relay		
Range:	Function:	
0.01 s*	[0.01 - 600 s]	Enter the delay of the relay cutout time.

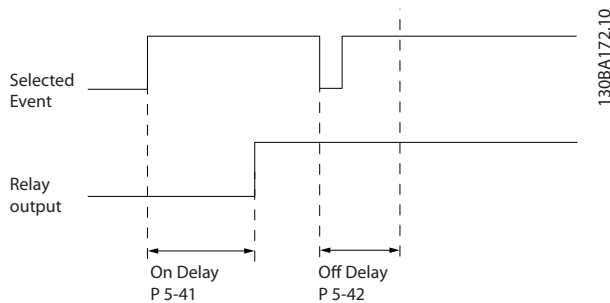

Illustration 4.11 Off Delay, Relay

If the selected event condition changes before the on- or off delay timer expires, the relay output is unaffected.

4.6.4 5-5* Pulse Input

The pulse input parameters are used to define an appropriate window for the impulse reference area by configuring the scaling and filter settings for the pulse inputs. Input terminals 29 or 33 act as frequency reference inputs. Set terminal 29 (*parameter 5-13 Terminal 29 Digital Input*) or terminal 33 (*parameter 5-15 Terminal 33 Digital Input*) to [32] *Pulse input*. If terminal 29 is used as an input, then set *parameter 5-01 Terminal 27 Mode* to [0] *Input*.

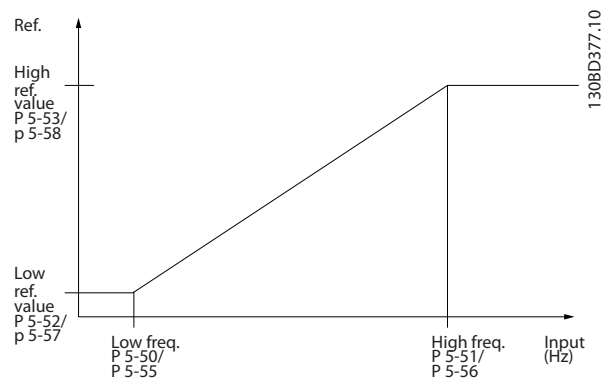

Illustration 4.12 Pulse Input

5-50 Term. 29 Low Frequency		
Range:	Function:	
4 Hz*	[4 - 31999 Hz]	Enter the low frequency limit corresponding to the low motor shaft speed (that is low reference value) in <i>parameter 5-52 Term. 29 Low Ref./Feedb. Value</i> . Refer to <i>Illustration 4.12</i> .

5-51 Term. 29 High Frequency		
Range:	Function:	
32000 Hz*	[5 - 32000 Hz]	Enter the high frequency limit corresponding to the high motor shaft speed (which is high reference value) in <i>parameter 5-53 Term. 29 High Ref./Feedb. Value</i> .

5-52 Term. 29 Low Ref./Feedb. Value		
Range:	Function:	
0*	[-4999 - 4999]	Enter the low reference value limit for the motor shaft speed [Hz]. This value is also the lowest feedback value, see also <i>parameter 5-57 Term. 33 Low Ref./Feedb. Value</i> . Set terminal 29 to digital input (<i>parameter 5-02 Terminal 29 Mode=[0] Input</i> and <i>parameter 5-13 Terminal 29 Digital Input=applicable value</i>).

5-53 Term. 29 High Ref./Feedb. Value		
Range:	Function:	
Size related*	[-4999 - 4999]	Enter the high reference value [Hz] for the motor shaft speed, and the high feedback value. See also <i>parameter 5-58 Term. 33 High Ref./Feedb. Value</i> . Select terminal 29 as a digital input (<i>parameter 5-02 Terminal 29 Mode=[0] Input</i> (default) and <i>parameter 5-13 Terminal 29 Digital Input=applicable value</i>).

5-55 Term. 33 Low Frequency		
Range:	Function:	
4 Hz* [4 - 31999 Hz]	Enter the low frequency corresponding to the low motor shaft speed (which is low reference value) in <i>parameter 5-57 Term. 33 Low Ref./Feedb. Value</i> .	

5-56 Term. 33 High Frequency		
Range:	Function:	
32000 Hz* [5 - 32000 Hz]	Enter the high frequency corresponding to the high motor shaft speed (that is high reference value) in <i>parameter 5-58 Term. 33 High Ref./Feedb. Value</i> .	

5-57 Term. 33 Low Ref./Feedb. Value		
Range:	Function:	
0* [-4999 - 4999]	Enter the low reference value [Hz] for the motor shaft speed. This value is also the low feedback value, see also <i>parameter 5-52 Term. 29 Low Ref./Feedb. Value</i> .	

5-58 Term. 33 High Ref./Feedb. Value		
Range:	Function:	
Size related* [-4999 - 4999]	Enter the high reference value [Hz] for the motor shaft speed. See also <i>parameter 5-53 Term. 29 High Ref./Feedb. Value</i> .	

5-60 Terminal 27 Pulse Output Variable		
Option:	Function:	
[0] *	No operation	
[45]	Bus ctrl.	
[48]	Bus ctrl., timeout	
[100]	Output frequency	
[101]	Reference	
[102]	Process Feedback	
[103]	Motor Current	
[104]	Torque rel to limit	
[105]	Torq relate to rated	
[106]	Power	
[107]	Speed	
[109]	Max Out Freq	
[113]	Ext. Closed Loop 1	

5-62 Pulse Output Max Freq 27		
Range:	Function:	
5000 Hz* [4 - 32000 Hz]	Set the maximum frequency for terminal 27, corresponding to the output variable selected in <i>parameter 5-60 Terminal 27 Pulse Output Variable</i> .	

5-70 Term 32/33 Pulses Per Revolution		
Range:	Function:	
1024* [1 - 4096]	Set the encoder pulses per revolution on the motor shaft. Read the correct value from the encoder.	

5-71 Term 32/33 Encoder Direction		
Option:	Function:	
	NOTICE This parameter cannot be adjusted while the motor is running. Change the detected encoder rotation direction without changing the wiring to the encoder.	
[0] *	Clockwise	Set channel A 90° (electrical degrees) behind channel B after clockwise rotation of the encoder shaft.
[1]	Counter clockwise	Set channel A 90° (electrical degrees) ahead of channel B after clockwise rotation of the encoder shaft.

5-90 Digital & Relay Bus Control		
Range:	Function:	
0* [0 - 0xFFFFFFFF]	This parameter holds the state of the bus-controlled digital outputs and relays. A logical 1 indicates that the output is high or active. A logical 0 indicates that the output is low or inactive.	

Bit 0-3	Reserved
Bit 4	Relay 1 output terminal
Bit 6-23	Reserved
Bit 24	Terminal 42 digital output
Bit 26-31	Reserved

Table 4.4 Bit Functions

5-93 Pulse Out 27 Bus Control		
Range:	Function:	
0 %* [0 - 100 %]	Set the output frequency transferred to the output terminal 27 when the terminal is configured as [45] <i>Bus Controlled</i> in <i>parameter 5-60 Terminal 27 Pulse Output Variable</i> .	

5-94 Pulse Out 27 Timeout Preset		
Range:	Function:	
0 %* [0 - 100 %]	Set the output frequency transferred to the output terminal 27 when the terminal is configured as [48] <i>Bus Ctrl Timeout</i> in <i>parameter 5-60 Terminal 27 Pulse Output Variable</i> and a timeout is detected.	

4.7 Parameters: 6-** Analog In/Out

6-00 Live Zero Timeout Time		
Range:	Function:	
10 s*	[1 - 99 s]	Enter the timeout time.

6-01 Live Zero Timeout Function		
Option:	Function:	
	Select the timeout function. The function set in <i>parameter 6-01 Live Zero Timeout Function</i> is activated if the input signal on terminal 53 or 54 is below 50% of the value in <i>parameter 6-10 Terminal 53 Low Voltage</i> , <i>parameter 6-20 Terminal 54 Low Voltage</i> , or <i>parameter 6-22 Terminal 54 Low Current</i> for a time period defined in <i>parameter 6-00 Live Zero Timeout Time</i> .	
[0] *	Off	
[1]	Freeze output	
[2]	Stop	
[3]	Jogging	
[4]	Max. speed	
[5]	Stop and trip	

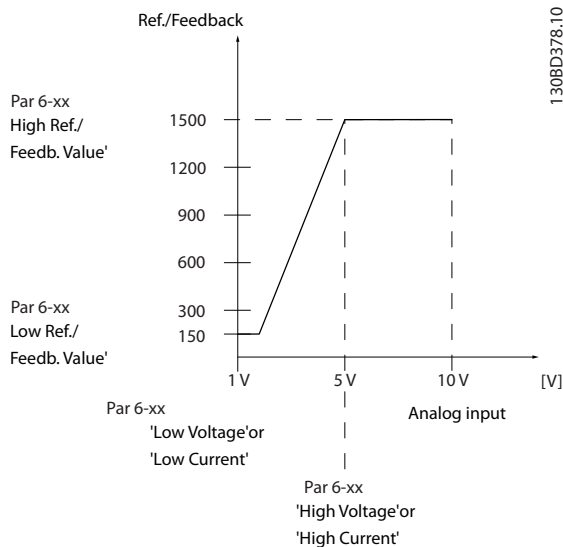

Illustration 4.13 Timeout Function

6-10 Terminal 53 Low Voltage		
Range:	Function:	
0.07 V*	[0 - 10 V]	Enter the voltage (V) that corresponds to <i>parameter 6-14 Terminal 53 Low Ref./Feedb. Value</i> . To activate <i>parameter 6-01 Live Zero Timeout Function</i> , set the value at >1 V.

6-11 Terminal 53 High Voltage		
Range:	Function:	
10 V*	[0 - 10 V]	Enter the voltage (V) that corresponds to the high reference value (set in <i>parameter 6-15 Terminal 53 High Ref./Feedb. Value</i>).

6-14 Terminal 53 Low Ref./Feedb. Value		
Range:	Function:	
0*	[-4999 - 4999]	Enter the reference or feedback value that corresponds to the voltage or current set in <i>parameter 6-10 Terminal 53 Low Voltage</i> .

6-15 Terminal 53 High Ref./Feedb. Value		
Range:	Function:	
Size related*	[-4999 - 4999]	Enter the reference or feedback value that corresponds to the voltage or current set in <i>parameter 6-11 Terminal 53 High Voltage</i> .

6-16 Terminal 53 Filter Time Constant		
Range:	Function:	
0.01 s*	[0.01 - 10 s]	Enter the time constant. This constant is a first-order digital low-pass filter time constant for suppressing electrical noise in terminal 53. A high time constant value improves dampening, but also increases the time delay through the filter.

6-18 Terminal 53 Digital Input		
Option:	Function:	
[0] *	No operation	
[1]	Reset	
[2]	Coast inverse	
[3]	Coast and reset inverse	
[4]	Quick stop inverse	
[5]	DC-brake inverse	
[6]	Stop inverse	
[8]	Start	
[10]	Reversing	
[11]	Start reversing	
[12]	Enable start forward	
[13]	Enable start reverse	
[14]	Jog	
[15]	Preset reference on	
[16]	Preset ref bit 0	
[17]	Preset ref bit 1	
[18]	Preset ref bit 2	
[19]	Freeze reference	
[20]	Freeze output	
[21]	Speed up	
[22]	Speed down	
[23]	Set-up select bit 0	
[24]	Set-up select bit 1	

6-18 Terminal 53 Digital Input		
Option:	Function:	
[28]	Catch up	
[29]	Slow down	
[34]	Ramp bit 0	
[35]	Ramp bit 1	
[51]	External Interlock	
[55]	DigiPot increase	
[56]	DigiPot decrease	
[57]	DigiPot clear	
[58]	DigiPot Hoist	
[72]	PID error inverse	
[73]	PID reset I part	
[74]	PID enable	
[150]	Go To Home	
[151]	Home Ref. Switch	
[155]	HW Limit Positive Inv	
[156]	HW Limit Negative Inv	
[157]	Pos. Quick Stop Inv	
[160]	Go To Target Pos.	
[162]	Pos. Idx Bit0	
[163]	Pos. Idx Bit1	
[164]	Pos. Idx Bit2	
[171]	Limit switch cw inverse	
[172]	Limit switch ccw inverse	

6-19 Terminal 53 mode

Select the terminal 53 input mode.

Option:	Function:	
[1] *	Voltage mode	
[6]	Digital input	

6-20 Terminal 54 Low Voltage

Range:	Function:	
0.07 V* [0 - 10 V]	Enter the voltage (V) that corresponds to the low reference value (set in <i>parameter 6-24 Terminal 54 Low Ref./Feedb. Value</i>). To activate <i>parameter 6-01 Live Zero Timeout Function</i> , set the value at >1 V.	

6-21 Terminal 54 High Voltage

Range:	Function:	
10 V* [0 - 10 V]	Enter the voltage (V) that corresponds to the high reference value (set in <i>parameter 6-25 Terminal 54 High Ref./Feedb. Value</i>).	

6-22 Terminal 54 Low Current

Range:	Function:	
4 mA* [0 - 20 mA]	Enter the low current value. This reference signal corresponds to the low reference/feedback value set in <i>parameter 6-24 Terminal 54 Low Ref./Feedb. Value</i> . To activate the live	

6-22 Terminal 54 Low Current

Range:	Function:	
	zero timeout function in <i>parameter 6-01 Live Zero Timeout Function</i> , set the value to >2 mA.	

6-23 Terminal 54 High Current

Range:	Function:	
20 mA* [0 - 20 mA]	Enter the high current value corresponding to the high reference/feedback value set in <i>parameter 6-25 Terminal 54 High Ref./Feedb. Value</i> .	

6-24 Terminal 54 Low Ref./Feedb. Value

Range:	Function:	
0* [-4999 - 4999]	Enter the reference or feedback value that corresponds to the voltage or current set in <i>parameter 6-21 Terminal 54 High Voltage/parameter 6-22 Terminal 54 Low Current</i> .	

6-25 Terminal 54 High Ref./Feedb. Value

Range:	Function:	
Size related* [-4999 - 4999]	Enter the reference or feedback value that corresponds to the voltage or current set in <i>parameter 6-21 Terminal 54 High Voltage/parameter 6-23 Terminal 54 High Current</i> .	

6-26 Terminal 54 Filter Time Constant

Range:	Function:	
0.01 s* [0.01 - 10 s]	Enter the time constant, which is a first-order digital low-pass filter time constant for suppressing electrical noise in terminal 54. A high time constant value improves dampening, but also increases the time delay through the filter.	

6-29 Terminal 54 mode

Option:	Function:	
	Select if terminal 54 is used for current input or voltage input.	
[0]	Current mode	
[1] *	Voltage mode	

6-90 Terminal 42 Mode

Option:	Function:	
	Set terminal 42 to act as analog output or as digital output. When digital output is set, terminal 42 outputs 0 mA as OFF or 20 mA as ON. External resistor (≥ 1 k Ω) should be connected between terminals 42 and 55.	
[0] *	0-20 mA	
[1]	4-20 mA	

6-90 Terminal 42 Mode		
Option:	Function:	
[2]	Digital Output	

6-91 Terminal 42 Analog Output		
Option:	Function:	
[0] *	No operation	
[100]	Output frequency	
[101]	Reference	
[102]	Process Feedback	
[103]	Motor Current	
[104]	Torque rel to limit	
[105]	Torq relate to rated	
[106]	Power	
[107]	Speed	
[111]	Speed Feedback	
[113]	Ext. Closed Loop 1	
[139]	Bus Control	
[143]	Ext. CL 1	
[254]	DC Link Voltage	

6-92 Terminal 42 Digital Output		
Option:	Function:	
[0] *	No operation	
[1]	Control Ready	
[2]	Drive ready	
[3]	Drive rdy/rem ctrl	
[4]	Stand-by / no warning	
[5]	Running	
[6]	Running / no warning	
[7]	Run in range/no warn	
[8]	Run on ref/no warn	
[9]	Alarm	
[10]	Alarm or warning	
[11]	At torque limit	
[12]	Out of current range	
[13]	Below current, low	
[14]	Above current, high	
[15]	Out of frequency range	
[16]	Below frequency, low	
[17]	Above frequency, high	
[18]	Out of feedb. range	
[19]	Below feedback, low	
[20]	Above feedback, high	
[21]	Thermal warning	
[22]	Ready, no thermal warning	
[23]	Remote,ready,no TW	
[24]	Ready, no over-/ under voltage	
[25]	Reverse	
[26]	Bus OK	
[27]	Torque limit & stop	
[28]	Brake, no brake warning	

6-92 Terminal 42 Digital Output		
Option:	Function:	
[29]	Brake ready, no fault	
[30]	Brake fault (IGBT)	
[31]	Relay 123	
[32]	Mech brake ctrl	
[36]	Control word bit 11	
[37]	Control word bit 12	
[40]	Out of ref range	
[41]	Below reference, low	
[42]	Above ref, high	
[45]	Bus ctrl.	
[46]	Bus control, timeout: On	
[47]	Bus control, timeout: Off	
[56]	Heat sink cleaning warning, high	
[60]	Comparator 0	
[61]	Comparator 1	
[62]	Comparator 2	
[63]	Comparator 3	
[64]	Comparator 4	
[65]	Comparator 5	
[70]	Logic rule 0	
[71]	Logic rule 1	
[72]	Logic rule 2	
[73]	Logic rule 3	
[74]	Logic rule 4	
[75]	Logic rule 5	
[80]	SL digital output A	
[81]	SL digital output B	
[82]	SL digital output C	
[83]	SL digital output D	
[160]	No alarm	
[161]	Running reverse	
[165]	Local ref active	
[166]	Remote ref active	
[167]	Start command activ	
[168]	Drive in hand mode	
[169]	Drive in auto mode	
[170]	Homing Completed	The homing operation is completed. This option is only effective when <i>parameter 37-00 Application Mode</i> is set to [2] <i>Position Control</i> .
[171]	Target Position Reached	The target position is reached. This option is only effective when <i>parameter 37-00 Application Mode</i> is set to [2] <i>Position Control</i> .
[172]	Position Control Fault	A fault occurred in the positioning process. Refer to <i>parameter 37-18 Pos. Ctrl Fault</i>

6-92 Terminal 42 Digital Output		
Option:	Function:	
		Reason for details about the fault. This option is only effective when <i>parameter 37-00 Application Mode</i> is set to [2] <i>Position Control</i> .
[173]	Position Mech Brake	Select mechanical control for positioning. This option is only effective when <i>parameter 37-00 Application Mode</i> is set to [2] <i>Position Control</i> .
[193]	Sleep Mode	The frequency converter/system has entered sleep mode. See <i>parameter group 22-4* Sleep Mode</i> .
[194]	Broken Belt Function	A broken-belt condition has been detected. See <i>parameter group 22-4* Sleep Mode</i> .
[198]	Drive Bypass	

6-93 Terminal 42 Output Min Scale		
Range:	Function:	
0 %* [0 - 200 %]	Scale for the minimum output (0 mA or 4 mA) of the analog signal at terminal 42. Set the value to be the percentage of the full range of the variable selected in <i>parameter 6-91 Terminal 42 Analog Output</i> .	

6-94 Terminal 42 Output Max Scale		
Range:	Function:	
100 %* [0 - 200 %]	Scale for maximum output (20 mA) of the scaling at terminal 42. Set the value to be the percentage of the full range of the variable selected in <i>parameter 6-91 Terminal 42 Analog Output</i> .	
	<p style="text-align: center;">Illustration 4.14 Output Scale versus Current</p>	

6-96 Terminal 42 Output Bus Control		
Range:	Function:	
0* [0 - 16384]	Hold the analog output at terminal 42 if controlled by bus.	

6-98 Drive Type		
Range:	Function:	
0* [0 - 0]		

4.8 Parameters: 7-** Controllers

7-00 Speed PID Feedback Source		
Option:	Function:	
		NOTICE This parameter cannot be changed while the motor is running.
		Select feedback source for speed CL control.
[1]	24V encoder	
[6]	Analog Input 53	
[7]	Analog Input 54	
[8]	Frequency input 29	
[9]	Frequency input 33	
[20] *	None	

7-02 Speed PID Proportional Gain		
Range:	Function:	
0.015* [0 - 1]	Enter the speed controller proportional gain. The proportional gain amplifies the error (that is the deviation between the feedback signal and the setpoint). This parameter is used with <i>parameter 1-00 Configuration Mode [1] Speed closed loop control</i> . Quick control is obtained at high amplification. However, if the amplification is too high, the process may become unstable.	

7-03 Speed PID Integral Time		
Range:	Function:	
8 ms* [2 - 20000 ms]	Enter the speed controller integral time, which determines the time the internal PID control takes to correct errors. The greater the error, the more quickly the gain increases. The integral time causes a delay of the signal and therefore a dampening effect, and can be used to eliminate steady-state speed error. Obtain quick control through a short integral time, though if the integral time is too short, the process becomes unstable. An excessively long integral time disables the integral action, leading to major deviations from the required reference, since the process regulator takes too long to regulate errors. This parameter is used with [1] <i>Speed closed loop control</i> set in <i>parameter 1-00 Configuration Mode</i> .	

7-04 Speed PID Differentiation Time		
Range:	Function:	
30 ms* [0 - 200 ms]	Enter the speed controller differentiation time. The differentiator does not react to constant error. It provides gain proportional to the rate of change of the speed feedback. The quicker the error changes, the stronger the gain from	

7-04 Speed PID Differentiation Time		
Range:	Function:	
		the differentiator. The gain is proportional with the speed at which errors change. Setting this parameter to 0 disables the differentiator. This parameter is used with <i>parameter 1-00 Configuration Mode [1] Speed closed loop control</i> .

7-05 Speed PID Diff. Gain Limit		
Range:	Function:	
5* [1 - 20]	Set a limit for the gain provided by the differentiator. Since the differential gain increases at higher frequencies, limiting the gain may be useful. For example, set up a pure D-link at low frequencies and a constant D-link at higher frequencies. This parameter is used with <i>parameter 1-00 Configuration Mode [1] Speed closed loop control</i> .	

7-06 Speed PID Lowpass Filter Time												
Range:	Function:											
10 ms* [1 - 6000 ms]	<p>NOTICE Severe filtering can be detrimental to dynamic performance. This parameter is used with <i>parameter 1-00 Configuration Mode [1] Speed closed loop</i>.</p> <p>Set a time constant for the speed control low-pass filter. The low-pass filter improves steady-state performance and dampens oscillations on the feedback signal. This parameter is useful if there is a great amount of noise in the system, see <i>Illustration 4.15</i>. For example, if a time constant (τ) of 100 ms is programmed, the cutoff frequency for the low-pass filter is $1/0.1=10$ RAD/s., corresponding to $(10/2 \times \pi)=1.6$ Hz. The PID regulator only regulates a feedback signal that varies by a frequency of less than 1.6 Hz. If the feedback signal varies by a higher frequency than 1.6 Hz, the PID regulator does not react. Practical settings of <i>parameter 7-06 Speed PID Lowpass Filter Time</i> taken from the number of pulses per revolutions from encoder:</p> <table border="1"> <thead> <tr> <th>Encoder PPR</th> <th>Parameter 7-06 Speed PID Lowpass Filter Time</th> </tr> </thead> <tbody> <tr> <td>512</td> <td>10 ms</td> </tr> <tr> <td>1024</td> <td>5 ms</td> </tr> <tr> <td>2048</td> <td>2 ms</td> </tr> <tr> <td>4096</td> <td>1 ms</td> </tr> </tbody> </table>		Encoder PPR	Parameter 7-06 Speed PID Lowpass Filter Time	512	10 ms	1024	5 ms	2048	2 ms	4096	1 ms
Encoder PPR	Parameter 7-06 Speed PID Lowpass Filter Time											
512	10 ms											
1024	5 ms											
2048	2 ms											
4096	1 ms											

7-06 Speed PID Lowpass Filter Time

Range: **Function:**

Illustration 4.15 Feedback Signal

7-07 Speed PID Feedback Gear Ratio

Range: **Function:**

1* [0.0001 - 32]

Illustration 4.16 Speed PID Feedback Gear Ratio

The frequency converter multiplies the speed feedback by this ratio.

7-08 Speed PID Feed Forward Factor

Range: **Function:**

0 %* [0 - 500 %] The reference signal bypasses the speed controller by the amount specified. This feature increases the dynamic performance of the speed control loop.

7-12 Torque PID Proportional Gain

Range: **Function:**

100 %* [0 - 500 %] Enter the proportional gain value for the torque controller. Selection of a high value makes the controller react faster. Too high a setting leads to controller instability.

7-13 Torque PID Integration Time

Range: **Function:**

0.020 s* [0.002 - 2 s] Enter the integration time for the torque controller. The lower the integration time, the faster the controller reacts. However, too low a setting leads to controller instability.

7-20 Process CL Feedback 1 Resource

Option: **Function:**

The effective feedback signal is made up of the sum of up to 2 different input signals. Select which input is treated as the source of the first of these signals. The 2nd input signal is defined in parameter 7-22 Process CL Feedback 2 Resource.

[0] *	No function	
[1]	Analog Input 53	
[2]	Analog Input 54	
[3]	Frequency input 29	
[4]	Frequency input 33	

7-22 Process CL Feedback 2 Resource

Option: **Function:**

The effective feedback signal is made up of the sum of up to 2 different input signals. Select which input is treated as the source of the 2nd of these signals. The 1st input signal is defined in parameter 7-20 Process CL Feedback 1 Resource.

[0] *	No function	
[1]	Analog Input 53	
[2]	Analog Input 54	
[3]	Frequency input 29	
[4]	Frequency input 33	

7-30 Process PID Normal/ Inverse Control

Option: **Function:**

Normal and inverse controls are implemented by introducing a difference between the reference signal and the feedback signal.

[0] *	Normal	Set process control to increase the output frequency.
[1]	Inverse	Set process control to decrease the output frequency.

7-31 Process PID Anti Windup		
Option:	Function:	
[0]	Off	Continue regulation of an error even when the output frequency cannot be increased or decreased.
[1] *	On	Cease regulation of an error when the output frequency can no longer be adjusted.

7-32 Process PID Start Speed		
Range:	Function:	
0 RPM*	[0 - 6000 RPM]	Enter the motor speed to be attained as a start signal for commencement of PID control. When the power is switched on, the frequency converter starts to ramp and then operates under speed open-loop control. When the process PID start speed is reached, the frequency converter changes to process PID control.

7-33 Process PID Proportional Gain		
Range:	Function:	
0.01*	[0 - 10]	Enter the PID proportional gain. The proportional gain multiplies the error between the setpoint and the feedback signal.

7-34 Process PID Integral Time		
Range:	Function:	
9999 s*	[0.10 - 9999 s]	Enter the PID integral time. The integrator provides an increasing gain at a constant error between the setpoint and the feedback signal. The integral time is the time needed by the integrator to reach the same gain as the proportional gain.

7-35 Process PID Differentiation Time		
Range:	Function:	
0 s*	[0 - 20 s]	Enter the PID differentiation time. The differentiator does not react to a constant error, but provides a gain only when the error changes. The shorter the PID differentiation time, the stronger the gain from the differentiator.

7-36 Process PID Diff. Gain Limit		
Range:	Function:	
5*	[1 - 50]	Enter a limit for the differentiator gain. If there is no limit, the differentiator gain increases when there are fast changes. To obtain a pure differentiator gain at slow changes and a constant differentiator gain where fast changes occur, limit the differentiator gain.

7-38 Process PID Feed Forward Factor		
Range:	Function:	
0 %*	[0 - 200 %]	Enter the PID feed forward (FF) factor. The FF factor sends a constant fraction of the reference signal to bypass the PID control, so the PID control only affects the remaining fraction of the control signal. Any change to this parameter affects the motor speed. When the FF factor is activated, it provides less overshoot, and high dynamics when changing the setpoint. <i>Parameter 7-38 Process PID Feed Forward Factor is active when parameter 1-00 Configuration Mode is set to [3] Process.</i>

7-39 On Reference Bandwidth		
Range:	Function:	
5 %*	[0 - 200 %]	Enter the on-reference bandwidth. When the PID control error (the difference between the reference and the feedback) is less than the value of this parameter, the on-reference status bit is 1.

7-40 Process PID I-part Reset		
Option:	Function:	
[0] *	No	
[1]	Yes	Select [1] Yes to reset the I-part of the process PID controller. The selection automatically returns to [0] No. Resetting the I-part makes it possible to start from a well-defined point after changing something in the process, for example changing a textile roll.

7-41 Process PID Output Neg. Clamp		
Range:	Function:	
-100 %*	[-100 - 100 %]	Enter a negative limit for the process PID controller output.

7-42 Process PID Output Pos. Clamp		
Range:	Function:	
100 %*	[-100 - 100 %]	Enter a positive limit for the process PID controller output.

7-43 Process PID Gain Scale at Min. Ref.		
Range:	Function:	
100 %*	[0 - 100 %]	Enter a scaling percentage to apply to the process PID output when operating at the minimum reference. The scaling percentage is adjusted linearly between the scale at minimum reference (<i>parameter 7-43 Process PID Gain Scale at Min. Ref.</i>) and the scale at maximum reference (<i>parameter 7-44 Process PID Gain Scale at Max. Ref.</i>).

7-44 Process PID Gain Scale at Max. Ref.		
Range:		Function:
100 %*	[0 - 100 %]	Enter a scaling percentage to apply to the process PID output when operating at the maximum reference. The scaling percentage is adjusted linearly between the scale at minimum reference (<i>parameter 7-43 Process PID Gain Scale at Min. Ref.</i>) and the scale at maximum reference (<i>parameter 7-44 Process PID Gain Scale at Max. Ref.</i>).

7-45 Process PID Feed Fwd Resource		
Option:		Function:
		Select which frequency converter input is used as the feed forward factor. The FF factor is added directly to the output of the PID controller. This parameter can increase dynamic performance.
[0] *	No function	
[1]	Analog Input 53	
[2]	Analog Input 54	
[7]	Frequency input 29	
[8]	Frequency input 33	
[11]	Local bus reference	
[32]	Bus PCD	

7-46 Process PID Feed Fwd Normal/ Inv. Ctrl.		
Option:		Function:
[0] *	Normal	Select <i>[0] Normal</i> to set the feed-forward factor to treat the FF resource as a positive value.
[1]	Inverse	Select <i>[1] Inverse</i> to treat the feed forward resource as a negative value.

7-48 PCD Feed Forward		
Range:		Function:
0*	[0 - 65535]	Readout parameter where the bus <i>parameter 7-45 Process PID Feed Fwd Resource [32]</i> can be read.

7-49 Process PID Output Normal/ Inv. Ctrl.		
Option:		Function:
[0] *	Normal	Select <i>[0] Normal</i> to use the resulting output from the process PID controller as is.
[1]	Inverse	Select <i>[1] Inverse</i> to invert the resulting output from the process PID controller. This operation is performed after the feed forward factor is applied.

7-50 Process PID Extended PID		
Option:		Function:
[0]	Disabled	Disable the extended parts of the process PID controller.
[1] *	Enabled	Enable the extended parts of the PID controller.

7-51 Process PID Feed Fwd Gain		
Range:		Function:
1*	[0 - 100]	The feed forward is used to obtain the gain, based on a well-known signal available. The PID controller then only takes care of the smaller part of the control, necessary because of unknown characters. The standard feed-forward factor in <i>parameter 7-38 Process PID Feed Forward Factor</i> is always related to the reference whereas <i>parameter 7-51 Process PID Feed Fwd Gain</i> has more options. In winder applications, the feed-forward factor is typically the line speed of the system.

7-52 Process PID Feed Fwd Ramp up		
Range:		Function:
0.01 s*	[0.01 - 100 s]	Control dynamics of the feed-forward signal when ramping up.

7-53 Process PID Feed Fwd Ramp down		
Range:		Function:
0.01 s*	[0.01 - 100 s]	Control the dynamics of the feed-forward signal when ramping down.

7-56 Process PID Ref. Filter Time		
Range:		Function:
0.001 s*	[0.001 - 1 s]	Set a time constant for the reference first-order low-pass filter. The low-pass filter improves steady-state performance and dampens oscillations on the reference/ feedback signals. However, severe filtering can be detrimental to dynamic performance.

7-57 Process PID Fb. Filter Time		
Range:		Function:
0.001 s*	[0.001 - 1 s]	Set a time constant for the feedback first-order low-pass filter. The low-pass filter improves steady-state performance and dampens oscillations on the reference/ feedback signals. However, severe filtering can be detrimental to dynamic performance.

7-60 Feedback 1 Conversion		
Select a conversion for the feedback 1 signal. Select <i>[0] Linear</i> to leave the feedback signal unchanged.		
Option:		Function:
[0] *	Linear	
[1]	Square root	

7-62 Feedback 2 Conversion

Select a conversion for the feedback 2 signal. Select [0] *Linear* to leave the feedback signal unchanged.

Option:

Function:

[0] *	Linear	
[1]	Square root	

4.9 Parameters: 8-** Communications and Options

8-01 Control Site		
Option:	Function:	
		The setting in this parameter overrides the settings in <i>parameter 8-50 Coasting Select</i> to <i>parameter 8-58 Profdrive OFF3 Select</i> .
[0] *	Digital and ctrl.word	Control by using both digital input and control word.
[1]	Digital only	Control by using digital inputs only.
[2]	Controlword only	Control by using control word only.

8-02 Control Source		
Option:	Function:	
		Select the source of the control word. NOTICE This parameter cannot be adjusted while the motor is running.
[0]	None	
[1]	FC Port	
[2]	FC USB	
[3]	Option A	

8-03 Control Timeout Time		
Range:	Function:	
1 s*	[0.1 - 6000 s]	Enter the maximum time expected to pass between the reception of 2 consecutive telegrams. If this time is exceeded, it indicates that the serial communication has stopped. The function that is selected in <i>parameter 8-04 Control Timeout Function</i> is then carried out.

8-04 Control Timeout Function		
Option:	Function:	
[0] *	Off	Select the timeout function. The timeout function is activated when the control word fails to be updated within the time period specified in <i>parameter 8-03 Control Timeout Time</i> .
[1]	Freeze output	
[2]	Stop	
[3]	Jogging	
[4]	Max. speed	
[5]	Stop and trip	

8-07 Diagnosis Trigger		
Option:	Function:	
[0] *	Disable	Send no extended diagnosis data (EDD).
[1]	Trigger on alarms	Send EDD upon alarms.
[2]	Trigger alarm/warn.	Send EDD upon alarms or warnings in <i>parameter 16-90 Alarm Word</i> , <i>parameter 9-53 Profibus Warning Word</i> , or <i>parameter 16-92 Warning Word</i> .

8-10 Control Word Profile		
Option:	Function:	
Select the interpretation of the control and status words corresponding to the installed fieldbus.		
[0] *	FC profile	
[1]	PROFdrive profile	
[5]	ODVA	
[7]	CANopen DSP 402	

8-14 Configurable Control Word CTW		
Option:	Function:	
The control word has 16 bits (0–15). Bits 10 and 12–15 are configurable.		
[0]	None	
[1] *	Profile default	
[2]	CTW Valid, active low	
[4]	PID error inverse	
[5]	PID reset I part	
[6]	PID enable	

8-19 Product Code		
Range:	Function:	
Size related*	[0 - 2147483647]	Select 0 to read out the actual fieldbus product code according to the mounted fieldbus option. Select 1 to read out the actual vendor ID.

8-30 Protocol		
Option:	Function:	
		Select the protocol for the integrated RS485 port.
[0] *	FC	Communication according to the FC protocol.
[2]	Modbus RTU	Communication according to the Modbus RTU protocol.

8-31 Address		
Range:	Function:	
1*	[0 - 247]	Enter the address for the RS485 port. Valid range: 1–126 for FC-bus, or 1–247 for Modbus.

8-32 Baud Rate
Option: **Function:**

		Select the baud rate for the RS485 port.
[0]	2400 Baud	
[1]	4800 Baud	
[2] *	9600 Baud	
[3]	19200 Baud	
[4]	38400 Baud	
[5]	57600 Baud	
[6]	76800 Baud	
[7]	115200 Baud	

8-33 Parity / Stop Bits

Parity and stop bits for the protocol using the FC port. For some of the protocols, not all options are available.

Option: **Function:**

[0]	Even Parity, 1 Stop Bit	
[1]	Odd Parity, 1 Stop Bit	
[2]	No Parity, 1 Stop Bit	
[3]	No Parity, 2 Stop Bits	

8-35 Minimum Response Delay
Range: **Function:**

0.01 s*	[0.0010 - 0.5 s]	Specify the minimum delay time between receiving a request and transmitting a response. This is used for overcoming modem turn-around delays.
---------	-------------------	---

8-36 Maximum Response Delay
Range: **Function:**

Size related*	[0.1 - 10.0 s]	Specify the maximum allowed delay time between receiving a request and transmitting the response. If this time is exceeded, no response is returned.
---------------	-----------------	--

8-37 Maximum Inter-char delay
Range: **Function:**

0.025 s*	[0.025 - 0.025 s]	Specify the maximum delay time between 2 characters in a message. Exceeding this delay time causes the message to be discarded.
----------	-------------------	---

8-42 PCD Write Configuration

Select the parameters to be assigned to the PCD's telegrams. The number of available PCDs depends on the telegram type. The values in the PCDs are then written to the selected parameters as data values.

Option: **Function:**

[0]	None	
[1]	[302] Minimum Reference	
[2]	[303] Maximum Reference	
[3]	[341] Ramp 1 Ramp up time	
[4]	[342] Ramp 1 Ramp down time	

8-42 PCD Write Configuration

Select the parameters to be assigned to the PCD's telegrams. The number of available PCDs depends on the telegram type. The values in the PCDs are then written to the selected parameters as data values.

Option: **Function:**

[5]	[351] Ramp 2 Ramp up time	
[6]	[352] Ramp 2 Ramp down time	
[7]	[380] Jog Ramp Time	
[8]	[381] Quick Stop Time	
[9]	[412] Motor Speed Low Limit [Hz]	
[10]	[414] Motor Speed High Limit [Hz]	
[11]	[590] Digital & Relay Bus Control	
[12]	[676] Terminal45 Output Bus Control	
[13]	[696] Terminal 42 Output Bus Control	
[14]	[894] Bus Feedback 1	
[15]	FC Port CTW	
[16]	FC Port REF	

8-43 PCD Read Configuration

Select the parameters to be assigned to the PCDs of the telegrams. The number of available PCDs depends on the telegram type. PCDs contain the actual data values of the selected parameters.

Option: **Function:**

[0] *	None	
[1]	[1500] Operation Hours	
[2]	[1501] Running Hours	
[3]	[1502] kWh Counter	
[4]	[1600] Control Word	
[5]	[1601] Reference [Unit]	
[6]	[1602] Reference %	
[7]	[1603] Status Word	
[8]	[1605] Main Actual Value [%]	
[9]	[1609] Custom Readout	
[10]	[1610] Power [kW]	
[11]	[1611] Power [hp]	
[12]	[1612] Motor Voltage	
[13]	[1613] Frequency	
[14]	[1614] Motor Current	
[15]	[1615] Frequency [%]	
[16]	[1616] Torque [Nm]	
[17]	[1618] Motor Thermal	
[18]	[1630] DC Link Voltage	
[19]	[1634] Heatsink Temp.	
[20]	[1635] Inverter Thermal	
[21]	[1638] SL Controller State	
[22]	[1650] External Reference	
[23]	[1652] Feedback [Unit]	

8-43 PCD Read Configuration

Select the parameters to be assigned to the PCDs of the telegrams. The number of available PCDs depends on the telegram type. PCDs contain the actual data values of the selected parameters.

Option: **Function:**

[24]	[1660] Digital Input 18, 19, 27, 29, 32, 33	
[25]	[1661] Terminal 53 Switch Setting	
[26]	[1662] Analog Input 53(V)	
[27]	[1663] Terminal 54 Switch Setting	
[28]	[1664] Analog Input 54	
[29]	[1665] Analog Output 42 [mA]	
[30]	[1671] Relay Output [bin]	
[31]	[1672] Counter A	
[32]	[1673] Counter B	
[33]	[1690] Alarm Word	
[34]	[1692] Warning Word	
[35]	[1694] Ext. Status Word	

8-50 Coasting Select

Option: **Function:**

		Select control of the coasting function via the terminals (digital input) and/or via the bus.
[0]	Digital input	Activate coasting command via a digital input.
[1]	Bus	Activate coasting command via the serial communication port or fieldbus option.
[2]	Logic AND	Activate coasting command via the fieldbus/serial communication port and 1 extra digital input.
[3] *	Logic OR	Activate coasting command via the fieldbus/serial communication port or via 1 of the digital inputs.

8-51 Quick Stop Select

Select the trigger for the quick stop function.

Option: **Function:**

[0]	Digital input	
[1]	Bus	
[2]	Logic AND	
[3] *	Logic OR	

8-52 DC Brake Select

Option: **Function:**

		Select control of the DC brake via the terminals (digital input) and/or via the fieldbus.
		NOTICE When parameter 1-10 Motor Construction is set to [1] PM non-salient SPM, only selection [0] Digital input is available.

8-52 DC Brake Select

Option: **Function:**

[0]	Digital input	Activate DC brake command via a digital input.
[1]	Bus	Activate DC brake command via the serial communication port or fieldbus option.
[2]	Logic AND	Activate DC brake command via the fieldbus/serial communication port and additionally via 1 of the digital inputs.
[3] *	Logic OR	Activate DC brake command via the fieldbus/serial communication port or via 1 of the digital inputs.

8-53 Start Select

Option: **Function:**

		Select the trigger for the start function.
[0]	Digital input	A digital input triggers the start function.
[1]	Bus	A serial communication port or the fieldbus triggers the start function.
[2]	Logic AND	The fieldbus/serial communication port and a digital input trigger the start function.
[3] *	Logic OR	The fieldbus/serial communication port or a digital input triggers the start function.

8-54 Reversing Select

Option: **Function:**

		Select the trigger for the reversing function.
[0]	Digital input	A digital input triggers the reversing function.
[1]	Bus	A serial communication port or the fieldbus triggers the reversing function.
[2]	Logic AND	The fieldbus/serial communication port and a digital input trigger the reversing function.
[3] *	Logic OR	The fieldbus/serial communication port or a digital input trigger the reversing function.

8-55 Set-up Select

Option: **Function:**

		Select the trigger for the set-up selection.
[0]	Digital input	A digital input triggers the set-up selection.
[1]	Bus	A serial communication port or the fieldbus triggers the set-up selection.
[2]	Logic AND	The fieldbus/serial communication port and a digital input trigger the set-up selection.
[3] *	Logic OR	The fieldbus/serial communication port or a digital input triggers the set-up selection.

8-56 Preset Reference Select		
Option:	Function:	
		Select the trigger for the preset reference selection.
[0]	Digital input	A digital input triggers the preset reference selection.
[1]	Bus	A serial communication port or the fieldbus triggers the preset reference selection.
[2]	Logic AND	The fieldbus/serial communication port and a digital input trigger the preset reference selection.
[3] *	Logic OR	The fieldbus/serial communication port or a digital input triggers the preset reference selection.

8-57 Profdrive OFF2 Select		
Select control of the frequency converter OFF2 selection via the terminals (digital input) and/or via the fieldbus. This parameter is active only when <i>parameter 8-01 Control Site</i> is set to [0] <i>Digital and ctrl. word</i> and <i>parameter 8-10 Control Word Profile</i> is set to [1] <i>Profdrive profile</i> .		
Option:	Function:	
[0]	Digital input	
[1]	Bus	
[2]	Logic AND	
[3] *	Logic OR	

8-58 Profdrive OFF3 Select		
Select control of the frequency converter OFF3 selection via the terminals (digital input) and/or via the fieldbus. This parameter is active only when <i>parameter 8-01 Control Site</i> is set to [0] <i>Digital and ctrl. word</i> , and <i>parameter 8-10 Control Word Profile</i> is set to [1] <i>Profdrive profile</i> .		
Option:	Function:	
[0]	Digital input	
[1]	Bus	
[2]	Logic AND	
[3] *	Logic OR	

8-79 Protocol Firmware version		
Range:	Function:	
Size related*	[0 - 65535]	Firmware revision: FC is in index 0; Modbus is in index 1; indexes 2-4 are reserved.

8-80 Bus Message Count		
Range:	Function:	
0*	[0 - 4294967295]	This parameter shows the number of valid telegrams detected on the bus.

8-81 Bus Error Count		
Range:	Function:	
0*	[0 - 4294967295]	This parameter shows the number of telegrams with faults (for example CRC faults) detected on the bus.

8-82 Slave Messages Rcvd		
Range:	Function:	
0*	[0 - 4294967295]	This parameter shows the number of valid telegrams sent by the frequency converter to the slave.

8-83 Slave Error Count		
Range:	Function:	
0*	[0 - 4294967295]	This parameter shows the number of error telegrams, which could not be executed by the frequency converter.

8-84 Slave Messages Sent		
Range:	Function:	
0*	[0 - 4294967295]	This parameter shows the number of messages sent from the slave.

8-85 Slave Timeout Errors		
Range:	Function:	
0*	[0 - 4294967295]	This parameter shows the number of slave timeout errors.

8-88 Reset FC port Diagnostics		
Reset all FC port diagnostic counters.		
Option:	Function:	
[0] *	Do not reset	
[1]	Reset counter	

8-90 Bus Jog 1 Speed		
Range:	Function:	
100 RPM*	[0 - 1500 RPM]	Enter the jog speed. This is a fixed jog speed activated via the serial port or fieldbus option.

8-91 Bus Jog 2 Speed		
Range:	Function:	
200 RPM*	[0 - 1500 RPM]	Enter the jog speed. This value is a fixed jog speed activated via the serial port or fieldbus option.

4.10 Parameters: 9-** PROFIdrive

For PROFIBUS parameter descriptions, see the *VLT® Midi Drive FC 280 PROFIBUS DP Programming Guide*.

For PROFINET parameter descriptions, see the *VLT® Midi Drive FC 280 PROFINET Programming Guide*.

4.11 Parameters: 10-** CAN Fieldbus

For CAN Fieldbus parameter descriptions, see the *VLT® Midi Drive FC 280 CANopen Programming Guide*.

4.12 Parameters: 12-** Ethernet

For Ethernet parameter descriptions, see the *VLT® Midi Drive FC 280 EtherNet/IP Programming Guide* and *VLT® Midi Drive FC 280 PROFINET Programming Guide*.

4.13 Parameters: 13-** Smart Logic Control

13-00 SL Controller Mode		
Option:	Function:	
[0] *	Off	Disable the smart logic controller.
[1]	On	Enable the smart logic controller.

13-01 Start Event		
Select the condition (true or false) which activates the smart logic controller.		
Option:	Function:	
[0]	False	
[1]	True	
[2]	Running	
[3]	In range	
[4]	On reference	
[7]	Out of current range	
[8]	Below I low	
[9]	Above I high	
[16]	Thermal warning	
[17]	Mains out of range	
[18]	Reversing	
[19]	Warning	
[20]	Alarm (trip)	
[21]	Alarm (trip lock)	
[22]	Comparator 0	
[23]	Comparator 1	
[24]	Comparator 2	
[25]	Comparator 3	
[26]	Logic rule 0	
[27]	Logic rule 1	
[28]	Logic rule 2	
[29]	Logic rule 3	
[33]	Digital input DI18	
[34]	Digital input DI19	
[35]	Digital input DI27	
[36]	Digital input DI29	
[39] *	Start command	
[40]	Drive stopped	
[42]	Auto Reset Trip	
[50]	Comparator 4	
[51]	Comparator 5	
[60]	Logic rule 4	
[61]	Logic rule 5	
[83]	Broken Belt	

13-02 Stop Event		
Select the condition (true or false) which deactivates the smart logic controller.		
Option:	Function:	
[0]	False	
[1]	True	
[2]	Running	
[3]	In range	

13-02 Stop Event		
Select the condition (true or false) which deactivates the smart logic controller.		
Option:	Function:	
[4]	On reference	
[7]	Out of current range	
[8]	Below I low	
[9]	Above I high	
[16]	Thermal warning	
[17]	Mains out of range	
[18]	Reversing	
[19]	Warning	
[20]	Alarm (trip)	
[21]	Alarm (trip lock)	
[22]	Comparator 0	
[23]	Comparator 1	
[24]	Comparator 2	
[25]	Comparator 3	
[26]	Logic rule 0	
[27]	Logic rule 1	
[28]	Logic rule 2	
[29]	Logic rule 3	
[30]	SL Time-out 0	
[31]	SL Time-out 1	
[32]	SL Time-out 2	
[33]	Digital input DI18	
[34]	Digital input DI19	
[35]	Digital input DI27	
[36]	Digital input DI29	
[39]	Start command	
[40] *	Drive stopped	
[42]	Auto Reset Trip	
[50]	Comparator 4	
[51]	Comparator 5	
[60]	Logic rule 4	
[61]	Logic rule 5	
[70]	SL Time-out 3	
[71]	SL Time-out 4	
[72]	SL Time-out 5	
[73]	SL Time-out 6	
[74]	SL Time-out 7	
[83]	Broken Belt	

13-03 Reset SLC		
Option:	Function:	
[0] *	Do not reset SLC	Retain programmed settings in <i>parameter group 13.** Smart Logic</i> .
[1]	Reset SLC	Reset all parameters in <i>parameter group 13.** Smart Logic</i> to default settings.

13-10 Comparator Operand		
Select the variable to be monitored by the comparator. This is an array parameter containing comparators 0 to 5.		
Option:	Function:	
[0] *	Disabled	
[1]	Reference %	
[2]	Feedback %	
[3]	Motor speed	
[4]	Motor Current	
[6]	Motor power	
[7]	Motor voltage	
[12]	Analog input AI53	
[13]	Analog input AI54	
[18]	Pulse input FI29	
[19]	Pulse input FI33	
[20]	Alarm number	
[30]	Counter A	
[31]	Counter B	

13-11 Comparator Operator		
Option:	Function:	
		Select the operator to be used in the comparison. This is an array parameter containing comparator operators 0–5.
[0]	Less Than (<)	The result of the evaluation is true, when the variable selected in <i>parameter 13-10 Comparator Operand</i> is smaller than the fixed value in <i>parameter 13-12 Comparator Value</i> . The result is false, if the variable selected in <i>parameter 13-10 Comparator Operand</i> is greater than the fixed value in <i>parameter 13-12 Comparator Value</i> .
[1] *	Approx.Equal (~)	The result of the evaluation is true, when the variable speed selected in <i>parameter 13-10 Comparator Operand</i> is approximately equal to the fixed value in <i>parameter 13-12 Comparator Value</i> .
[2]	Greater Than (>)	Inverse logic of [0] Less Than (<).

13-12 Comparator Value		
Range:	Function:	
0*	[-9999 - 9999]	Enter the trigger level for the variable that is monitored by this comparator. This is an array parameter containing comparator values 0–5.

13-20 SL Controller Timer		
Range:	Function:	
0 s* [0 - 3600 s]	Enter the value to define the duration of the false output from the programmed timer. A timer is only false if it is started by an action (for example [29] Start timer 1) and until the given timer value has elapsed.	

13-40 Logic Rule Boolean 1		
Option:	Function:	
	Select the 1 st boolean (true or false) input for the selected logic rule. See <i>parameter 13-01 Start Event ([0]–[61])</i> and <i>parameter 13-02 Stop Event ([70]–[74])</i> for further description.	
[0] *	False	
[1]	True	
[2]	Running	
[3]	In range	
[4]	On reference	
[7]	Out of current range	
[8]	Below I low	
[9]	Above I high	
[16]	Thermal warning	
[17]	Mains out of range	
[18]	Reversing	
[19]	Warning	
[20]	Alarm (trip)	
[21]	Alarm (trip lock)	
[22]	Comparator 0	
[23]	Comparator 1	
[24]	Comparator 2	
[25]	Comparator 3	
[26]	Logic rule 0	
[27]	Logic rule 1	
[28]	Logic rule 2	
[29]	Logic rule 3	
[30]	SL Time-out 0	
[31]	SL Time-out 1	
[32]	SL Time-out 2	
[33]	Digital input DI18	
[34]	Digital input DI19	
[35]	Digital input DI27	
[36]	Digital input DI29	
[39]	Start command	
[40]	Drive stopped	
[42]	Auto Reset Trip	
[50]	Comparator 4	
[51]	Comparator 5	
[60]	Logic rule 4	
[61]	Logic rule 5	
[70]	SL Time-out 3	
[71]	SL Time-out 4	
[72]	SL Time-out 5	

13-40 Logic Rule Boolean 1		
Option:	Function:	
[73]	SL Time-out 6	
[74]	SL Time-out 7	
[83]	Broken Belt	

13-41 Logic Rule Operator 1		
Option:	Function:	
	Select the 1 st logical operator to use on the boolean inputs from <i>parameter 13-40 Logic Rule Boolean 1</i> and <i>parameter 13-42 Logic Rule Boolean 2</i> .	
[0] *	Disabled	Ignore <i>parameter 13-42 Logic Rule Boolean 2</i> , <i>parameter 13-43 Logic Rule Operator 2</i> , and <i>parameter 13-44 Logic Rule Boolean 3</i> .
[1]	AND	Evaluate the expression [13-40] AND [13-42].
[2]	OR	Evaluate the expression [13-40] OR [13-42].
[3]	AND NOT	Evaluate the expression [13-40] AND NOT [13-42].
[4]	OR NOT	Evaluate the expression [13-40] OR NOT [13-42].
[5]	NOT AND	Evaluate the expression NOT [13-40] AND [13-42].
[6]	NOT OR	Evaluate the expression NOT [13-40] OR [13-42].
[7]	NOT AND NOT	Evaluate the expression NOT [13-40] AND NOT [13-42].
[8]	NOT OR NOT	Evaluate the expression NOT [13-40] OR NOT [13-42].

13-42 Logic Rule Boolean 2		
Option:	Function:	
	Select the 2 nd boolean (true or false) input for the selected logic rule. See <i>parameter 13-01 Start Event ([0]–[61])</i> , and <i>parameter 13-02 Stop Event ([70]–[74])</i> for further description.	
[0] *	False	
[1]	True	
[2]	Running	
[3]	In range	
[4]	On reference	
[7]	Out of current range	
[8]	Below I low	
[9]	Above I high	
[16]	Thermal warning	
[17]	Mains out of range	
[18]	Reversing	
[19]	Warning	
[20]	Alarm (trip)	
[21]	Alarm (trip lock)	
[22]	Comparator 0	

13-42 Logic Rule Boolean 2		
Option:	Function:	
[23]	Comparator 1	
[24]	Comparator 2	
[25]	Comparator 3	
[26]	Logic rule 0	
[27]	Logic rule 1	
[28]	Logic rule 2	
[29]	Logic rule 3	
[30]	SL Time-out 0	
[31]	SL Time-out 1	
[32]	SL Time-out 2	
[33]	Digital input DI18	
[34]	Digital input DI19	
[35]	Digital input DI27	
[36]	Digital input DI29	
[39]	Start command	
[40]	Drive stopped	
[42]	Auto Reset Trip	
[50]	Comparator 4	
[51]	Comparator 5	
[60]	Logic rule 4	
[61]	Logic rule 5	
[70]	SL Time-out 3	
[71]	SL Time-out 4	
[72]	SL Time-out 5	
[73]	SL Time-out 6	
[74]	SL Time-out 7	
[83]	Broken Belt	

13-43 Logic Rule Operator 2		
Option:	Function:	
		Select the 2 nd logical operator to be used on the boolean input calculated in <i>parameter 13-40 Logic Rule Boolean 1</i> , <i>parameter 13-41 Logic Rule Operator 1</i> , and <i>parameter 13-42 Logic Rule Boolean 2</i> , and the boolean input coming from <i>parameter 13-42 Logic Rule Boolean 2</i> . <i>Parameter 13-42 Logic Rule Boolean 2</i> signifies the boolean input of <i>parameter 13-44 Logic Rule Boolean 3</i> . <i>Parameter 13-40 Logic Rule Boolean 1</i> , and <i>parameter 13-42 Logic Rule Boolean 2</i> signify the boolean input calculated in <i>parameter 13-40 Logic Rule Boolean 1</i> , <i>parameter 13-41 Logic Rule Operator 1</i> , and <i>parameter 13-42 Logic Rule Boolean 2</i> .
[0] *	Disabled	Ignore <i>parameter 13-44 Logic Rule Boolean 3</i> .
[1]	AND	
[2]	OR	
[3]	AND NOT	
[4]	OR NOT	
[5]	NOT AND	

13-43 Logic Rule Operator 2		
Option:	Function:	
[6]	NOT OR	
[7]	NOT AND NOT	
[8]	NOT OR NOT	

13-44 Logic Rule Boolean 3		
Option:	Function:	
		Select the 3 rd boolean (true or false) input for the selected logic rule. See <i>parameter 13-40 Logic Rule Boolean 1</i> , <i>parameter 13-41 Logic Rule Operator 1</i> , and <i>parameter 13-42 Logic Rule Boolean 2</i> , and the boolean input. See <i>parameter 13-01 Start Event ([0]–[61])</i> , and <i>parameter 13-02 Stop Event ([70]–[74])</i> for further description.
[0] *	False	
[1]	True	
[2]	Running	
[3]	In range	
[4]	On reference	
[7]	Out of current range	
[8]	Below I low	
[9]	Above I high	
[16]	Thermal warning	
[17]	Mains out of range	
[18]	Reversing	
[19]	Warning	
[20]	Alarm (trip)	
[21]	Alarm (trip lock)	
[22]	Comparator 0	
[23]	Comparator 1	
[24]	Comparator 2	
[25]	Comparator 3	
[26]	Logic rule 0	
[27]	Logic rule 1	
[28]	Logic rule 2	
[29]	Logic rule 3	
[30]	SL Time-out 0	
[31]	SL Time-out 1	
[32]	SL Time-out 2	
[33]	Digital input DI18	
[34]	Digital input DI19	
[35]	Digital input DI27	
[36]	Digital input DI29	
[39]	Start command	
[40]	Drive stopped	
[42]	Auto Reset Trip	
[50]	Comparator 4	
[51]	Comparator 5	
[60]	Logic rule 4	
[61]	Logic rule 5	

13-44 Logic Rule Boolean 3		
Option:	Function:	
[70]	SL Time-out 3	
[71]	SL Time-out 4	
[72]	SL Time-out 5	
[73]	SL Time-out 6	
[74]	SL Time-out 7	
[83]	Broken Belt	

13-51 SL Controller Event		
Option:	Function:	
		Select the 3 rd boolean (true or false) input for the selected logic rule. See <i>parameter 13-40 Logic Rule Boolean 1</i> , <i>parameter 13-41 Logic Rule Operator 1</i> , <i>parameter 13-42 Logic Rule Boolean 2</i> , and the boolean input. See <i>parameter 13-01 Start Event ([0]–[61])</i> and <i>parameter 13-02 Stop Event ([70]–[74])</i> for further description.
[0] *	False	
[1]	True	
[2]	Running	
[3]	In range	
[4]	On reference	
[7]	Out of current range	
[8]	Below I low	
[9]	Above I high	
[16]	Thermal warning	
[17]	Mains out of range	
[18]	Reversing	
[19]	Warning	
[20]	Alarm (trip)	
[21]	Alarm (trip lock)	
[22]	Comparator 0	
[23]	Comparator 1	
[24]	Comparator 2	
[25]	Comparator 3	
[26]	Logic rule 0	
[27]	Logic rule 1	
[28]	Logic rule 2	
[29]	Logic rule 3	
[30]	SL Time-out 0	
[31]	SL Time-out 1	
[32]	SL Time-out 2	
[33]	Digital input DI18	
[34]	Digital input DI19	
[35]	Digital input DI27	
[36]	Digital input DI29	
[39]	Start command	
[40]	Drive stopped	
[42]	Auto Reset Trip	
[50]	Comparator 4	
[51]	Comparator 5	

13-51 SL Controller Event		
Option:	Function:	
[60]	Logic rule 4	
[61]	Logic rule 5	
[70]	SL Time-out 3	
[71]	SL Time-out 4	
[72]	SL Time-out 5	
[73]	SL Time-out 6	
[74]	SL Time-out 7	
[83]	Broken Belt	

13-52 SL Controller Action		
Option:	Function:	
[0] *	Disabled	Select the action corresponding to the SLC event. Actions are executed when the corresponding event (defined in <i>parameter 13-51 SL Controller Event</i>) is evaluated as true.
[1]	No action	
[2]	Select set-up 1	Change the active set-up (<i>parameter 0-10 Active Set-up</i>) to 1. If the set-up is changed, it merges with other set-up commands coming from either the digital inputs, or via a fieldbus.
[3]	Select set-up 2	Change the active set-up (<i>parameter 0-10 Active Set-up</i>) to 2. If the set-up is changed, it merges with other set-up commands coming from either the digital inputs, or via a fieldbus.
[4]	Select set-up 3	Change the active set-up (<i>parameter 0-10 Active Set-up</i>) to 3. If the set-up is changed, it merges with other set-up commands coming from either the digital inputs, or via a fieldbus.
[5]	Select set-up 4	Change the active set-up (<i>parameter 0-10 Active Set-up</i>) to 4. If the set-up is changed, it merges with other set-up commands coming from either the digital inputs, or via a fieldbus.
[10]	Select preset ref 0	Select preset reference 0. If the active preset reference is changed, it merges with other preset reference commands coming from either the digital inputs or via a fieldbus.
[11]	Select preset ref 1	Select preset reference 1. If the active preset reference is changed, it merges with other preset reference commands coming from either the digital inputs, or via a fieldbus.
[12]	Select preset ref 2	Select preset reference 2. If the active preset reference is changed, it merges with other preset reference commands coming from either the digital inputs, or via a fieldbus.
[13]	Select preset ref 3	Select preset reference 3. If the active preset reference is changed, it merges with other

13-52 SL Controller Action		
Option:	Function:	
		preset reference commands coming from either the digital inputs, or via a fieldbus.
[14]	Select preset ref 4	Select preset reference 4. If the active preset reference is changed, it merges with other preset reference commands coming from either the digital inputs, or via a fieldbus.
[15]	Select preset ref 5	Select preset reference 5. If the active preset reference is changed, it merges with other preset reference commands coming from either the digital inputs, or via a fieldbus.
[16]	Select preset ref 6	Select preset reference 6. If the active preset reference is changed, it merges with other preset reference commands coming from either the digital inputs, or via a fieldbus.
[17]	Select preset ref 7	Select preset reference 7. If the active preset reference is changed, it merges with other preset reference commands coming from either the digital inputs, or via a fieldbus.
[18]	Select ramp 1	Select ramp 1.
[19]	Select ramp 2	Select ramp 2.
[22]	Run	Issue a start command to the frequency converter.
[23]	Run reverse	Issue a start reverse command to the frequency converter.
[24]	Stop	Issue a stop command to the frequency converter.
[25]	Qstop	Issue a quick stop command to the frequency converter.
[26]	DC Brake	Issue a DC-brake command to the frequency converter.
[27]	Coast	The frequency converter coasts immediately. All stop commands including the coast command stop the SLC.
[28]	Freeze output	Freeze the output of the frequency converter.
[29]	Start timer 0	See <i>parameter 13-20 SL Controller Timer</i> for further description.
[30]	Start timer 1	See <i>parameter 13-20 SL Controller Timer</i> for further description.
[31]	Start timer 2	See <i>parameter 13-20 SL Controller Timer</i> for further description.
[32]	Set digital out A low	Any output with SL output A is low.
[33]	Set digital out B low	Any output with SL output B is low.
[34]	Set digital out C low	Any output with SL output C is low.

13-52 SL Controller Action		
Option:	Function:	
[35]	Set digital out D low	Any output with SL output D is low.
[38]	Set digital out A high	Any output with SL output A is high.
[39]	Set digital out B high	Any output with SL output B is high.
[40]	Set digital out C high	Any output with SL output C is high.
[41]	Set digital out D high	Any output with SL output D is high.
[60]	Reset Counter A	Reset counter A to 0.
[61]	Reset Counter B	Reset counter B to 0.
[70]	Start Timer 3	See <i>parameter 13-20 SL Controller Timer</i> for further description.
[71]	Start Timer 4	See <i>parameter 13-20 SL Controller Timer</i> for further description.
[72]	Start Timer 5	See <i>parameter 13-20 SL Controller Timer</i> for further description.
[73]	Start Timer 6	See <i>parameter 13-20 SL Controller Timer</i> for further description.
[74]	Start Timer 7	See <i>parameter 13-20 SL Controller Timer</i> for further description.

4.14 Parameters: 14-** Special Functions

14-01 Switching Frequency

Option:	Function:
	Select the inverter switching frequency. Changing the switching frequency helps to reduce acoustic noise from the motor.
[2]	2.0 kHz
[3]	3.0 kHz
[4]	4.0 kHz
[5]	5.0 kHz
[6]	6.0 kHz
[7]	8.0 kHz
[8]	10.0 kHz
[9]	12.0 kHz
[10]	16.0 kHz

14-03 Overmodulation

Option:	Function:
[0]	Off To avoid torque ripple on the motor shaft, select [0] Off for no overmodulation of the output voltage. This feature may be useful for applications such as grinding machines.
[1] *	On Select [1] On to enable the overmodulation function for the output voltage. Select this setting when it is required that the output voltage is >95% of the input voltage (typical when running oversynchronously). The output voltage is increased according to the degree of overmodulation. NOTICE Overmodulation leads to increased torque ripple as harmonics are increased.

14-07 Dead Time Compensation Level

Range:	Function:
Size related* [0 - 100]	Level of applied deadtime compensation in percentage. A high level (>90%) optimizes the dynamic motor response; a level 50–90% is good for both motor-torque-ripple minimization and the motor dynamics. A 0-level turns the deadtime compensation off.

14-08 Damping Gain Factor

Range:	Function:
Size related* [0 - 100 %]	Damping factor for DC-link voltage compensation.

14-09 Dead Time Bias Current Level

Range:	Function:
Size related* [0 - 100 %]	Set a bias signal (in [%]) to add to the current-sense signal for deadtime compensation for some motors.

14-10 Mains Failure

Option:	Function:
	NOTICE <i>Parameter 14-10 Mains Failure cannot be changed while motor is running.</i> <i>Parameter 14-10 Mains Failure is typically used where very short mains interruptions (voltage dips) are present. At 100% load and a short voltage interruption, the DC voltage on the main capacitors drops quickly. For larger frequency converters, it only takes a few milliseconds before the DC level is down to about 373 V DC and the IGBTs cut off and lose control of the motor. When mains is restored, and the IGBTs start again, the output frequency, and voltage vector do not correspond to the speed/frequency of the motor, and the result is normally an overvoltage or overcurrent, mostly resulting in a trip lock. Parameter 14-10 Mains Failure can be programmed to avoid this situation.</i> <i>Select the function to which the frequency converter must act when the threshold in parameter 14-11 Mains Voltage at Mains Fault has been reached.</i>
[0] *	No function The frequency converter does not compensate for a mains interruption. The voltage on the DC-link drops quickly, and the motor is lost within milliseconds to seconds. Trip lock is the result.
[1]	Ctrl. ramp-down The frequency converter remains control of the motor and does a controlled ramp-down from parameter 14-11 Mains Voltage at Mains Fault level. If parameter 2-10 Brake Function is [0] Off or [2] AC brake, the ramp follows the overvoltage ramping. If parameter 2-10 Brake Function is [1] Resistor Brake, the ramp follows the setting in parameter 3-81 Quick Stop Ramp Time. This selection is particularly useful in pump applications, where the inertia is low and the friction is high. When mains is restored, the output frequency ramps the motor up to the reference speed (if the mains interruption is prolonged, the controlled ramp-down might take the output frequency down to 0 RPM, and when the mains is restored, the application is ramped up from 0 RPM to the previous reference speed via the normal ramp up). If the energy in the DC-link disappears before the motor is ramped to 0, the motor is coasted.
[2]	Ctrl. ramp-down, trip This selection is similar to selection [1] Ctrl. ramp-down, except that in [2] Ctrl. ramp-down, trip a reset is necessary for starting up after power-up.
[3]	Coasting Centrifuges can run for an hour without power supply. In those situations, it is possible to select a

14-10 Mains Failure												
Option:	Function:											
		coast function at mains interruption, together with a flying start, which occurs when the mains is restored.										
[4]	Kinetic back-up	<p>Kinetic back-up ensures that the frequency converter keeps running as long as there is energy in the system due to the inertia from motor and load. This is done by converting the mechanical energy to the DC-link and thereby maintaining control of the frequency converter and motor. This can extend the controlled operation, depending on the inertia in the system. For fans, it is typically several seconds, for pumps up to 2 s and for compressors only for a fraction of a second. Many industry applications can extend controlled operation for many seconds, which is often enough time for the mains to return.</p> <table border="1"> <tr><td>A</td><td>Normal operation</td></tr> <tr><td>B</td><td>Mains failure</td></tr> <tr><td>C</td><td>Kinetic back-up</td></tr> <tr><td>D</td><td>Mains return</td></tr> <tr><td>E</td><td>Normal operation: Ramping</td></tr> </table> <p>Illustration 4.17 Kinetic Back-up</p> <p>The DC-level during [4] <i>Kinetic back-up</i> is parameter 14-11 <i>Mains Voltage at Mains Fault</i> x 1.35.</p> <p>If the mains does not return, U_{DC} is maintained as long as possible by ramping the speed down towards 0 RPM. Finally, the frequency converter coasts.</p> <p>If mains returns while in kinetic back-up, U_{DC} increases above parameter 14-11 <i>Mains Voltage at Mains Fault</i> x 1.35. This is detected in 1 of the following ways:</p> <ul style="list-style-type: none"> If $U_{DC} > \text{parameter 14-11 Mains Voltage at Mains Fault} \times 1.35 \times 1.05$ If the speed is above the reference. This is relevant if mains comes back at a lower level than before, for example, parameter 14-11 <i>Mains Voltage at Mains Fault</i> x 1.35 x 1.02. This does not fulfill the criterion above, and the frequency converter tries to reduce U_{DC} to parameter 14-11 <i>Mains Voltage at Mains</i> 	A	Normal operation	B	Mains failure	C	Kinetic back-up	D	Mains return	E	Normal operation: Ramping
A	Normal operation											
B	Mains failure											
C	Kinetic back-up											
D	Mains return											
E	Normal operation: Ramping											

14-10 Mains Failure										
Option:	Function:									
		<p><i>Fault</i> x 1.35 by increasing the speed. This does not succeed as mains cannot be lowered.</p> <ul style="list-style-type: none"> If running motoric. The same mechanism as in the previous point, but where the inertia prevents that the speed goes above the reference speed. This leads to the motor running motoric until the speed is above the reference speed, and the above situation occurs. Instead of waiting for that, the present criterion is introduced. 								
[5]	Kinetic back-up, trip	<p>The difference between kinetic back-up with and without trip is that the latter always ramps down to 0 RPM and trips, regardless of whether mains return or not.</p> <p>The function is made so that it does not even detect if mains return, this is the reason for the relatively high level on the DC-link during ramp down.</p> <table border="1"> <tr><td>A</td><td>Normal operation</td></tr> <tr><td>B</td><td>Mains failure</td></tr> <tr><td>C</td><td>Kinetic back-up</td></tr> <tr><td>D</td><td>Trip</td></tr> </table> <p>Illustration 4.18 Kinetic Back-up Trip</p>	A	Normal operation	B	Mains failure	C	Kinetic back-up	D	Trip
A	Normal operation									
B	Mains failure									
C	Kinetic back-up									
D	Trip									
[6]	Alarm									
[7]	Kin. back-up, trip w recovery									

14-11 Mains Voltage at Mains Fault		
Range:	Function:	
342 V*	[100 - 800 V]	This parameter defines the threshold voltage at which the selected function in parameter 14-10 <i>Mains Failure</i> is activated. The detection level is at a factor $\sqrt{2}$ of the value in this parameter.

14-12 Function at Mains Imbalance

Option:	Function:
	Operation under severe mains imbalance conditions reduces the lifetime of the motor. Conditions are considered severe if the motor is operated continuously near nominal load (for example, a pump or fan running near full speed).
[0] *	Trip the frequency converter.
[1]	Warning Issue a warning.
[2]	Disabled No action is taken.

14-15 Kin. Backup Trip Recovery Level

Range:	Function:
Size related* [0 - 500.000 Reference-FeedbackUnit]	This parameter specifies the kinetic back-up trip recovery level.

14-20 Reset Mode

Option:	Function:
	<p>⚠ WARNING</p> <p>UNINTENDED START</p> <p>When the frequency converter is connected to AC mains, DC supply, or load sharing, the motor may start at any time. Unintended start during programming, service, or repair work can result in death, serious injury, or property damage. The motor can start via an external switch, a fieldbus command, an input reference signal from the LCP, or after a cleared fault condition. To prevent unintended motor start:</p> <ul style="list-style-type: none"> • Disconnect the frequency converter from the mains. • Press [Off/Reset] on the LCP before programming parameters. • Fully wire and assembly the frequency converter, motor, and any driven equipment before connecting the frequency converter to AC mains, DC supply, or load sharing.

14-20 Reset Mode

Option:	Function:
	<p>NOTICE</p> <p>If the specified number of automatic resets is reached within 10 minutes, the frequency converter enters [0] Manual reset mode. After the manual reset is performed, the setting of parameter 14-20 Reset Mode reverts to the original selection. If the number of automatic resets is not reached within 10 minutes, or when a manual reset is performed, the internal automatic reset counter returns to 0.</p> <p>Select the reset function after tripping. Once reset, the frequency converter can be restarted. Automatic reset mode does not affect alarm 68, Safe Torque Off and alarm 188, STO internal fault in software v1.2 and further versions.</p>
[0] *	Manual reset Select [0] Manual reset, to perform a reset via [Reset] or via the digital inputs.
[1]	Automatic reset x 1 Select [1]-[12] Automatic reset x 1...x 20 to perform between 1 and 20 automatic resets after tripping.
[2]	Automatic reset x 2
[3]	Automatic reset x 3
[4]	Automatic reset x 4
[5]	Automatic reset x 5
[6]	Automatic reset x 6
[7]	Automatic reset x 7
[8]	Automatic reset x 8
[9]	Automatic reset x 9
[10]	Automatic reset x 10
[11]	Automatic reset x 15
[12]	Automatic reset x 20
[13]	Infinite auto reset Select [13] Infinite Automatic Reset for continuous resetting after tripping.
[14]	Reset at power-up

14-21 Automatic Restart Time		
Range:	Function:	
10 s* [0 - 600 s]	Enter the time interval from trip to start of the automatic reset function. This parameter is active when <i>parameter 14-20 Reset Mode</i> is set to [1]-[13] <i>Automatic reset</i> .	

14-22 Operation Mode		
Option:	Function:	
	Specify normal operation, perform tests, or initialize all parameters except for <i>parameter 15-03 Power Up's</i> , <i>parameter 15-04 Over Temp's</i> , and <i>parameter 15-05 Over Volt's</i> . This function is only active when the power is cycled to the frequency converter.	
[0] *	Normal operation	Normal operation with motor selected.
[2]	Initialisation	Reset all parameter values to default settings, except for <i>parameter 15-03 Power Up's</i> , <i>parameter 15-04 Over Temp's</i> , and <i>parameter 15-05 Over Volt's</i> . The frequency converter resets during the next power-up.

14-24 Trip Delay at Current Limit		
Range:	Function:	
60 s* [0 - 60 s]	Enter the current limit trip delay in seconds. When the output current reaches the current limit (<i>parameter 4-18 Current Limit</i>), a warning is triggered. When the current limit warning has been continuously present for the period specified in this parameter, the frequency converter trips. To run continuously in current limit without tripping, set the parameter to 60 s=Off. Thermal monitoring of the frequency converter remains active.	

14-25 Trip Delay at Torque Limit		
Range:	Function:	
60 s* [0 - 60 s]	Enter the torque limit trip delay in seconds. When the output torque reaches the torque limits (<i>parameter 4-16 Torque Limit Motor Mode</i> and <i>parameter 4-17 Torque Limit Generator Mode</i>), a warning is triggered. When the torque limit warning has been continuously present for the period specified in this parameter, the frequency converter trips. Disable the trip delay by setting the parameter to 60 s=Off. Thermal monitoring of the frequency converter remains active.	

14-27 Action At Inverter Fault		
Option:	Function:	
	Select how the frequency converter reacts when an overvoltage or grounding fault occurs.	

14-27 Action At Inverter Fault		
Option:	Function:	
[0]	Trip	Disable the protection filters and trips at the first fault.
[1] *	Warning	Run the protection filters normally.

14-28 Production Settings		
Option:	Function:	
[0] *	No action	
[1]	Service reset	
[3]	Software Reset	

14-29 Service Code		
Range:	Function:	
0* [0 - 0x7FFFFFFF]	For internal use only.	

14-30 Current Lim Ctrl, Proportional Gain		
Range:	Function:	
100 %* [0 - 500 %]	Enter the proportional gain value for the current limit controller. Selection of a high value makes the controller react faster. Too high a setting leads to controller instability.	

14-31 Current Lim Ctrl, Integration Time		
Range:	Function:	
0.020 s* [0.002 - 2 s]	Control the current limit control integration time. Setting it to a lower value makes it react faster. A setting too low leads to control instability.	

14-32 Current Lim Ctrl, Filter Time		
Range:	Function:	
5 ms* [1 - 100 ms]	Set a time constant for the current limit controller low-pass filter.	

14-40 VT Level		
Range:	Function:	
66 % * [40 - 90 %]	<p>NOTICE This parameter cannot be adjusted while the motor is running.</p> <p>NOTICE This parameter is not active when <i>parameter 1-10 Motor Construction</i> is set to options that enable PM motor mode.</p> <p>Enter the level of motor magnetization at low speed. Selection of a low value reduces energy loss in the motor, but also reduces load capability.</p>	

14-41 AEO Minimum Magnetisation		
Range:		Function:
66 %*	[40 - 75 %]	Enter the minimum allowable magnetization for AEO. Selection of a low value reduces energy loss in the motor, but can also reduce resistance to sudden load changes.

14-44 d-axis current optimization for IPM		
Range:		Function:
100 %*	[0 - 200 %]	<p>This parameter is available only when <i>parameter 1-10 Motor Construction</i> is set to [2] PM, salient IPM, non-Sat.</p> <p>Normally, VVC⁺ PM control automatically optimizes d-axis demagnetizing current based on d-axis and q-axis settings. When <i>parameter 1-10 Motor Construction</i> is set to [2] PM, salient IPM, non-Sat, use this parameter to compensate the saturation effect at high load. Usually, decreasing this value improves the efficiency. However, 0% means no optimization and the d-axis current is 0 (not recommended).</p>

14-51 DC-Link Voltage Compensation		
Option:		Function:
[0]	Off	Disable DC-link compensation.
[1] *	On	Enable DC-link compensation.

14-52 Fan Control		
Option:		Function:
[5]	Constant-on mode	
[6]	Constant-off mode	
[7]	On-when-Inverter-is-on-else-off Mode	
[8] *	Variable-speed mode	

14-55 Output Filter		
Option:		Function:
		<p>NOTICE</p> <p>This parameter cannot be changed while the motor is running.</p> <p>Select the type of output filter connected.</p>
[0] *	No Filter	
[1]	Sine-Wave Filter	

14-61 Function at Inverter Overload		
When the frequency converter issues a frequency converter overload warning, select whether to continue and trip the frequency converter, or derate the output current.		
Option:		Function:
[0] *	Trip	
[1]	Derate	

14-63 Min Switch Frequency		
Option:		Function:
		Set the minimum switch frequency allowed by the output filter.
[2] *	2.0 kHz	
[3]	3.0 kHz	
[4]	4.0 kHz	
[5]	5.0 kHz	
[6]	6.0 kHz	
[7]	8.0 kHz	
[8]	10.0 kHz	
[9]	12.0 kHz	
[10]	16.0 kHz	

14-64 Dead Time Compensation Zero Current Level		
Option:		Function:
[0] *	Disabled	
[1]	Enabled	If using a long motor cable, select this option to minimize the motor torque ripple.

14-65 Speed Derate Dead Time Compensation		
Range:		Function:
Size related*	[20 - 1000 Hz]	Deadtime compensation level is reduced linearly versus output frequency from the maximum level set in <i>parameter 14-07 Dead Time Compensation Level</i> to a minimum level set in this parameter.

14-89 Option Detection		
Select the behavior when an option change is detected. This parameter returns to [0] <i>Protect Option Config.</i> after an option change.		
Option:		Function:
[0] *	Protect Option Config.	Freeze the current settings and prevents unwanted changes when missing or defective options are detected.
[1]	Enable Option Change	Settings can be changed when the system configuration is being modified.

14-90 Fault Level		
Use this parameter to customize fault levels. Use the 8 th element to control the fault level of <i>alarm 13, Overcurrent</i> .		
Option:		Function:
[3] *	Trip Lock	Alarm is set to trip-lock.
[4]	Trip w. delayed reset	Alarm is configured into trip alarm, which can be reset after a delay time. For example, if <i>alarm 13, Overcurrent</i> is configured to this option, it can be reset 3 minutes after the alarm.

4

14-90 Fault Level		
Use this parameter to customize fault levels. Use the 8 th element to control the fault level of <i>alarm 13, Overcurrent</i> .		
Option:		Function:
[5]	Flystart	At start-up, the frequency converter tries to catch a spinning motor. If this option is selected, <i>parameter 1-73 Flying Start</i> is forced to [1] Enabled.

Index	Alarm	Trip lock	Trip w. delayed	Flystart
0	Reserved	-	-	-
1	Reserved	-	-	-
2	Reserved	-	-	-
3	Reserved	-	-	-
4	Reserved	-	-	-
5	Reserved	-	-	-
6	Reserved	-	-	-
7	Overcurrent	D	x	x

Table 4.5 Table for Selection of Action when Selected Alarm Appears (*Parameter 14-90 Fault Level*)

D = Default setting

x = Possible selection

4.15 Parameters: 15-*** Drive Information

15-00 Operating hours		
Range:	Function:	
0 h*	[0 - 0x7ffffff. h]	View how many hours the frequency converter has run. The value is saved, when the frequency converter is turned off.

15-01 Running Hours		
Range:	Function:	
0 h*	[0 - 0x7ffffff. h]	View how many hours the frequency converter has run. Reset the counter in <i>parameter 15-07 Reset Running Hours Counter</i> . The value is saved, when the frequency converter is turned off.

15-02 kWh Counter		
Range:	Function:	
0 kWh*	[0 - 2147483647 kWh]	Register the power consumption of the motor as an average value over 1 hour. Reset the counter in <i>parameter 15-06 Reset kWh Counter</i> .

15-03 Power Up's		
Range:	Function:	
0*	[0 - 2147483647]	View the number of times the frequency converter has been powered up.

15-04 Over Temp's		
Range:	Function:	
0*	[0 - 65535]	View the number of frequency converter temperature faults.

15-05 Over Volt's		
Range:	Function:	
0*	[0 - 65535]	View the number of frequency converter overvoltages.

15-06 Reset kWh Counter		
Option:	Function:	
[0] *	Do not reset	No reset of the kWh counter is required.
[1]	Reset counter	Press [OK] to reset the kWh counter to 0 (see <i>parameter 15-02 kWh Counter</i>).

15-07 Reset Running Hours Counter		
Option:	Function:	
[0] *	Do not reset	
[1]	Reset counter	Press [OK] to reset the running hours counter to 0 (see <i>parameter 15-01 Running Hours</i>).

15-30 Alarm Log: Error Code		
Range:	Function:	
0*	[0 - 255]	View the error code and look up its meaning in <i>chapter 6 Troubleshooting</i> .

15-31 InternalFaultReason		
Range:	Function:	
0*	[-32767 - 32767]	View an extra description of the error. This parameter is mostly used in combination with <i>alarm 38, Internal Fault</i> .

15-40 FC Type		
Range:	Function:	
0*	[0 - 0]	View the frequency converter type. The readout is identical to the power field of the type code definition, characters 1-6.

15-41 Power Section		
Range:	Function:	
0*	[0 - 20]	View the FC type. The readout is identical to the power field of the type code definition, characters 7-10.

15-42 Voltage		
Range:	Function:	
0*	[0 - 20]	View the FC type. The readout is identical to the power field type of the type code definition, characters 11-12.

15-43 Software Version		
Range:	Function:	
0*	[0 - 5]	View the combined SW version (or package version) consisting of power SW and control SW.

15-44 Ordered Typecode String		
Range:	Function:	
0*	[0 - 40]	View the type code string used for reordering the frequency converter in its original configuration.

15-45 Actual Typecode String		
Range:	Function:	
0*	[0 - 40]	View the actual type code.

15-46 Drive Ordering No		
Range:	Function:	
0*	[0 - 0]	View the 8-digit ordering number used for reordering the frequency converter in its original configuration.

15-48 LCP Id No		
Range:	Function:	
0*	[0 - 20]	View the LCP ID number.

15-49 SW ID Control Card		
Range:	Function:	
0*	[0 - 20]	View the control card software version number.

15-50 SW ID Power Card		
Range:	Function:	
0*	[0 - 20]	View the power card software version number.

15-51 Frequency Converter Serial Number		
Range:	Function:	
0*	[0 - 10]	View the frequency converter serial number.

15-52 OEM Information		
Range:	Function:	
0*	[0 - 0]	View OEM information.

15-53 Power Card Serial Number		
Range:	Function:	
0*	[0 - 19]	View the power card serial number.

15-57 File Version		
Range:	Function:	
0*	[0 - 255]	View the file version.

15-59 Filename		
Range:	Function:	
0*	[0 - 16]	View the actual file name of OEM files.

15-60 Option Mounted		
Range:	Function:	
Size related*	[0 - 30]	View the installed option type.

15-61 Option SW Version		
Range:	Function:	
Size related*	[0 - 20]	View the installed option software version.

15-70 Option in Slot A		
Range:	Function:	
0*	[0 - 30]	View the type code string for the option installed in slot A, and a translation of the type code string.

15-71 Slot A Option SW Version		
Range:	Function:	
0*	[0 - 20]	View the software version for the option installed in slot A.

15-92 Defined Parameters		
Range:	Function:	
0*	[0 - 2000]	View a list of all defined parameters in the frequency converter. The list ends with 0.

15-97 Application Type		
Range:	Function:	
0*	[0 - 0xFFFFFFFF]	This parameter contains data used by MCT 10 Set-up Software.

15-98 Drive Identification		
Range:	Function:	
0*	[0 - 56]	This parameter contains data used by MCT 10 Set-up Software.

15-99 Parameter Metadata		
Range:	Function:	
0*	[0 - 9999]	This parameter contains data used by MCT 10 Set-up Software.

4.16 Parameters: 16-** Data Readouts

16-00 Control Word		
Range:	Function:	
0* [0 - 65535]	View the control word sent from the frequency converter via the serial communication port in hex code.	

16-01 Reference [Unit]		
Range:	Function:	
0 ReferenceFeed-backUnit*	[-4999 - 4999 ReferenceFeed-backUnit]	View the present reference value applied on impulse or analog basis in the unit resulting from the configuration selected in <i>parameter 1-00 Configuration Mode</i> .

16-02 Reference [%]		
Range:	Function:	
0 %* [-200 - 200 %]	View the total reference. The total reference is the sum of digital, analog, preset, bus, and freeze references, plus catch up and slow down.	

16-03 Status Word		
Range:	Function:	
0* [0 - 65535]	View the status word sent from the frequency converter via the serial communication port in hex code.	

16-05 Main Actual Value [%]		
Range:	Function:	
0 %* [-200 - 200 %]	View the 2-byte word sent with the status word to the bus master reporting the main actual value.	

16-09 Custom Readout		
Range:	Function:	
0 CustomReadoutUnit*	[0 - 9999 CustomReadoutUnit]	View the custom readout from <i>parameter 0-30 Custom Readout Unit</i> to <i>parameter 0-32 Custom Readout Max Value</i> .

16-10 Power [kW]		
Range:	Function:	
0 kW* [0 - 1000 kW]	Show motor power in kW. The calculated value shown is based on the actual DC-link voltage and DC-Link current. The value is filtered, and therefore approximately 128 ms may pass from when an input value changes to when the data readout values change. The resolution of readout value on fieldbus is in 1 W steps.	

16-11 Power [hp]		
Range:	Function:	
0 hp* [0 - 1000 hp]	View the motor power in hp. The value shown is calculated on the basis of the actual DC-link voltage and DC-link current. The value is filtered, and therefore approximately 128 ms may pass from when an input value changes to when the data readout values change.	

16-12 Motor Voltage		
Range:	Function:	
0 V* [0 - 65535 V]	View the motor voltage, a calculated value is used for controlling the motor.	

16-13 Frequency		
Range:	Function:	
0 Hz* [0 - 6553.5 Hz]	View the motor frequency, without resonance dampening.	

16-14 Motor current		
Range:	Function:	
0 A* [0 - 655.35 A]	View the motor current measured as an average value, I_{RMS} . The value is filtered, and approximately 30 ms may pass from when an input value changes to when the data readout values change.	

16-15 Frequency [%]		
Range:	Function:	
0 %* [0 - 6553.5 %]	View a 2-byte word reporting the actual motor frequency (without resonance dampening) as a percentage (scale 0000-4000 hex) of <i>parameter 4-19 Max Output Frequency</i> .	

16-16 Torque [Nm]		
Range:	Function:	
0 Nm [-30000 - 30000 Nm]	View the torque value with sign, applied to the motor shaft. Some motors supply more than 160% torque. As a result, the minimum value and the maximum value depend on the maximum motor current as well as the motor used.	

16-17 Speed [RPM]		
Range:	Function:	
0 RPM [-30000 - 30000 RPM]	View the actual motor RPM. In open-loop or closed-loop process control, the motor RPM is estimated. In speed closed-loop modes, the motor RPM is measured.	

16-18 Motor Thermal		
Range:	Function:	
0 %* [0 - 100 %]	View the calculated thermal load on the motor. The cutout limit is 100%. The basis for calculation is the ETR function selected in <i>parameter 1-90 Motor Thermal Protection</i> .	

16-20 Motor Angle		
Range:	Function:	
0* [0 - 65535]	View the current encoder angle offset relative to the index position. The value range of 0–65535 corresponds to 0–2xpi (radians).	

16-22 Torque [%]		
Range:	Function:	
0 %* [-200 - 200 %]	View the torque in percent of nominal torque, with sign, applied to the motor shaft.	

16-30 DC Link Voltage		
Range:	Function:	
0 V* [0 - 65535 V]	View a measured value. The value is filtered with a 30 ms time constant.	

16-33 Brake Energy Average		
Range:	Function:	
0 kW* [0 - 10000 kW]	View the brake power transmitted to an external brake resistor. The mean power is calculated on an average basis for the most recent 120 s.	

16-34 Heatsink Temp.		
Range:	Function:	
0 °C* [-128 - 127 °C]	View the frequency converter heat sink temperature.	

16-35 Inverter Thermal		
Range:	Function:	
0 %* [0 - 255 %]	View the percentage load on the inverter.	

16-36 Inv. Nom. Current		
Range:	Function:	
0 A* [0 - 655.35 A]	View the inverter nominal current, which should match the nameplate data on the connected motor. The data is used for calculation of torque and motor protection.	

16-37 Inv. Max. Current		
Range:	Function:	
0 A* [0 - 655.35 A]	View the inverter maximum current, which should match the nameplate data on the connected motor. The data is used for calculation of torque and motor protection.	

16-38 SL Controller State		
Range:	Function:	
0* [0 - 20]	View the state of the event under execution by the SL controller.	

16-39 Control Card Temp.		
Range:	Function:	
0 °C* [0 - 65535 °C]	View the temperature on the control card, stated in °C.	

16-50 External Reference		
Range:	Function:	
0 %* [-200 - 200 %]	View the total reference, the sum of digital, analog, preset, bus, and freeze references, plus catch-up and slow-down.	

16-52 Feedback[Unit]		
Range:	Function:	
0 ProcessCtrlUnit* [-4999 - 4999 ProcessCtrlUnit]	View the feedback unit resulting from the selection of unit and scaling in <i>parameter 3-00 Reference Range</i> , <i>parameter 3-01 Reference/Feedback Unit</i> , <i>parameter 3-02 Minimum Reference</i> , and <i>parameter 3-03 Maximum Reference</i> .	

16-53 Digi Pot Reference		
Range:	Function:	
0* [-200 - 200]	View the torque value with sign, applied to the motor shaft. Some motors supply more than 160% torque. As a result, the minimum value and the maximum value depend on the maximum motor current as well as the motor used.	

16-57 Feedback [RPM]		
Range:	Function:	
0 RPM* [-30000 - 30000 RPM]	Readout parameter where the actual motor RPM from the feedback source can be read in both closed loop and open loop. The feedback source is selected in <i>parameter 7-00 Speed PID Feedback Source</i> .	

16-60 Digital Input		
Range:	Function:	
0* [0 - 65535]	View the actual state of the digital inputs 18, 19, 27, 29, 32, and 33.	
	Bit 0	Digital input terminal 33
	Bit 1	Digital input terminal 32
	Bit 2	Digital input terminal 29
	Bit 3	Digital input terminal 27
	Bit 4	Digital input terminal 19
	Bit 5	Digital input terminal 18
	Bit 6-15	Unused
Table 4.6 Bits Definition		

16-61 Terminal 53 Setting		
Show the setting of input terminal 53.		
Option:	Function:	
[1]	Voltage mode	
[6]	Digital input	

16-62 Analog Input 53		
Range:	Function:	
1* [0 - 20]	View the actual value at input 53.	

16-63 Terminal 54 Setting		
Option:	Function:	
	View the setting of input terminal 54.	
[0]	Current mode	
[1]	Voltage mode	

16-64 Analog Input AI54		
Range:	Function:	
1* [0 - 20]	View the actual value at input 54.	

16-65 Analog Output 42 [mA]		
Range:	Function:	
0 mA* [0 - 20 mA]	View the actual value at output 42. The value shown reflects the selections in <i>parameter 6-90 Terminal 42 Mode</i> and <i>parameter 6-91 Terminal 42 Analog Output</i> .	

16-66 Digital Output		
Range:	Function:	
0* [0 - 15]	View the binary value of all digital outputs.	

16-67 Pulse Input #29 [Hz]		
Range:	Function:	
0* [0 - 130000]	View the actual frequency rate on terminal 29.	

16-68 Pulse Input 33 [Hz]		
Range:	Function:	
0* [0 - 130000]	View the actual value of the frequency applied at terminal 33 as an impulse input.	

16-69 Pulse Output 27 [Hz]		
Range:	Function:	
0* [0 - 40000]	View the actual value of impulses applied to terminal 27 in digital output mode.	

16-71 Relay Output		
Range:	Function:	
0* [0 - 65535]	View the settings of all relays.	

16-72 Counter A		
Range:	Function:	
0* [-32768 - 32767]	View the present value of counter A. Counters are useful as comparator operands, see <i>parameter 13-10 Comparator Operand</i> . The value can be reset or changed either via digital inputs (<i>parameter group 5-1* Digital Inputs</i>), or by using an SLC action (<i>parameter 13-52 SL Controller Action</i>).	

16-73 Counter B		
Range:	Function:	
0* [-32768 - 32767]	View the present value of counter B. Counters are useful as comparator operands (<i>parameter 13-10 Comparator Operand</i>). The value can be reset or changed either via digital inputs (<i>parameter group 5-1* Digital Inputs</i>) or by using an SLC action (<i>parameter 13-52 SL Controller Action</i>).	

16-74 Prec. Stop Counter		
Range:	Function:	
0* [0 - 2147483647]	Show the current value of the precise stop counter.	

16-80 Fieldbus CTW 1		
Range:	Function:	
0* [0 - 65535]	View the 2-byte control word (CTW) received from the bus master. Interpretation of the CTW depends on the fieldbus option installed and the CTW profile selected in <i>parameter 8-10 Control Word Profile</i> . For more information, see relevant fieldbus manuals.	

16-82 Fieldbus REF 1		
Range:	Function:	
0* [-32768 - 32767]	To set the reference value, view the 2-byte word sent with the control word from the bus master. For more information, refer to the relevant fieldbus manual.	

16-84 Comm. Option STW		
Range:	Function:	
0*	[0 - 65535]	View the extended fieldbus communication option status word. For more information, refer to the relevant fieldbus manual.

16-85 FC Port CTW 1		
Range:	Function:	
1084*	[0 - 65535]	View the 2-byte control word (CTW) received from the bus master. Interpretation of the control word depends on the fieldbus option installed and the control word profile selected in <i>parameter 8-10 Control Word Profile</i> .

16-86 FC Port REF 1		
Range:	Function:	
0*	[-32768 - 32767]	View the last received reference from the FC port.

16-90 Alarm Word		
Range:	Function:	
0*	[0 - 0xFFFFFFFFFUL]	View the alarm word sent via the serial communication port in hex code.

16-91 Alarm Word 2		
Range:	Function:	
0*	[0 - 0xFFFFFFFFFUL]	View the alarm word 2 sent via the serial communication port in hex code.

16-92 Warning Word		
Range:	Function:	
0*	[0 - 0xFFFFFFFFFUL]	View the warning word sent via the serial communication port in hex code.

16-93 Warning Word 2		
Range:	Function:	
0*	[0 - 0xFFFFFFFFFUL]	View the warning word 2 sent via the serial communication port in hex code.

16-94 Ext. Status Word		
Range:	Function:	
0*	[0 - 0xFFFFFFFFFUL]	Return the extended status word sent via the serial communication port in hex code.

16-95 Ext. Status Word 2		
Range:	Function:	
0*	[0 - 0xFFFFFFFFFUL]	Return the extended status word 2 sent via the serial communication port in hex code.

16-97 Alarm Word 3		
Range:	Function:	
0*	[0 - 0xFFFFFFFFFUL]	Show the alarm word 3 sent via the serial communication port in hex code.

4.17 Parameters: 18-** Data Readouts 2

18-90 Process PID Error		
Range:	Function:	
0 %* [-200 - 200 %]	Give the present error value used by the process PID controller.	

18-91 Process PID Output		
Range:	Function:	
0 %* [-200 - 200 %]	Give the present raw output value from the process PID controller.	

18-92 Process PID Clamped Output		
Range:	Function:	
0 %* [-200 - 200 %]	Give the present output value from the process PID controller after the clamp limits have been observed.	

18-93 Process PID Gain Scaled Output		
Range:	Function:	
0 %* [-200 - 200 %]	Give the present output value from the process PID controller after the clamp limits have been observed, and the resulting value has been gain scaled.	

4.18 Parameters: 21-** Ext. Closed Loop

21-09 Extended PID Enable		
Select the extended CL PID controller that is to be autotuned.		
Option:	Function:	
[0] *	Disabled	
[1]	Enabled Ext CL1 PID	

21-11 Ext. 1 Minimum Reference		
Range:	Function:	
0 ExtPID1Unit* [-999999.999 - 999999.999 ExtPID1Unit]	This parameter sets the minimum value that can be obtained by the sum setpoint and reference.	

21-12 Ext. 1 Maximum Reference		
Range:	Function:	
100 ExtPID1Unit [-999999.999 - 999999.999 ExtPID1Unit]	This parameter sets the maximum value that can be obtained by the sum of the setpoint and reference.	

21-13 Ext. 1 Reference Source		
This parameter defines which input on the frequency converter should be treated as the source of the reference signal.		
Option:	Function:	
[0] *	No function	
[1]	Analog Input 53	
[2]	Analog Input 54	
[7]	Frequency input 29	
[8]	Frequency input 33	

21-14 Ext. 1 Feedback Source		
This parameter defines which input on the frequency converter should be treated as the source of the feedback signal.		
Option:	Function:	
[0] *	No function	
[1]	Analog Input 53	
[2]	Analog Input 54	
[3]	Frequency input 29	
[4]	Frequency input 33	

21-15 Ext. 1 Setpoint		
Range:	Function:	
0 ExtPID1Unit* [-999999.999 - 999999.999 ExtPID1Unit]	This parameter is used as the reference for comparing feedback values. The setpoint can be offset with digital, analog, or bus references.	

21-17 Ext. 1 Reference [Unit]		
Range:	Function:	
0 ExtPID1Unit* [-999999.999 - 999999.999 ExtPID1Unit]	Return the resulting reference value.	

21-18 Ext. 1 Feedback [Unit]		
Range:	Function:	
0 ExtPID1Unit*	[-999999.999 - 999999.999 ExtPID1Unit]	Return the feedback value.

21-19 Ext. 1 Output [%]		
Range:	Function:	
0 %*	[0 - 100 %]	Return the extended closed loop 1 PID controller output value.

21-20 Ext. 1 Normal/Inverse Control		
Select [0] <i>Normal</i> if the controller output should be reduced when the feedback is higher than the reference. Select [1] <i>Inverse</i> if the output should be increased when the feedback is higher than the reference.		
Option:	Function:	
[0] *	Normal	
[1]	Inverse	

21-21 Ext. 1 Proportional Gain		
Range:	Function:	
0.01*	[0 - 10]	The proportional gain indicates the number of times the error between the setpoint and the feedback signal is to be applied.

21-22 Ext. 1 Integral Time		
Range:	Function:	
10000 s*	[0.01 - 10000 s]	The integrator provides an increasing gain at a constant error between the setpoint and the feedback signal. The integral time is the time needed by the integrator to reach the same gain as the proportional gain.

21-23 Ext. 1 Differentiation Time		
Range:	Function:	
0 s*	[0 - 10 s]	The differentiator does not react to a constant error. It only provides a gain when the error changes. The quicker the error changes, the stronger the gain from the differentiator.

21-24 Ext. 1 Dif. Gain Limit		
Range:	Function:	
5*	[1 - 50]	Set a limit for the differentiator gain (DG). The DG increases if there are fast changes. Limit the DG to obtain a pure differentiator gain at slow changes and a constant differentiator gain where quick changes occur.

4.19 Parameters: 22-** Application Functions

22-02 Sleepmode CL Control Mode		
This parameter is used to set whether feedback is detected for entering sleep mode in process closed loop.		
Option:		Function:
[0] *	Normal	Detect feedback together with other parameters.
[1]	Simplified	Do not detect feedback. Only check sleep speed and time.

22-40 Minimum Run Time		
Range:		Function:
10 s*	[0 - 600 s]	Set the wanted minimum running time for the motor after a start command (digital input or bus) before entering sleep mode.

22-41 Minimum Sleep Time		
Range:		Function:
10 s*	[0 - 600 s]	Set the minimum time for staying in sleep mode. This time overrides any wake-up conditions.

22-43 Wake-Up Speed [Hz]		
Range:		Function:
10*	[0 - 400.0]	Only to be used if <i>parameter 1-00 Configuration Mode</i> is set for [0] <i>Open loop</i> , and an external controller applies speed reference. Set the reference speed at which the sleep mode should be deactivated.

22-44 Wake-Up Ref./FB Diff		
Range:		Function:
10 % *	[0 - 100 %]	Only to be used if <i>parameter 1-00 Configuration Mode</i> is set for [1] <i>Closed loop</i> , and the integrated PI controller is used for controlling the pressure. Set the pressure drop allowed in percentage of setpoint for the pressure (P_{set}) before canceling the sleep mode.

22-45 Setpoint Boost		
Range:		Function:
0 % *	[-100 - 100 %]	Only to be used if <i>parameter 1-00 Configuration Mode</i> is set for [1] <i>Closed loop</i> , and the integrated PI controller is used. In systems with for example constant pressure control, it is advantageous to increase the system pressure before the motor is stopped. This extends the time in which the motor is stopped and helps to avoid frequent start/stop.

22-45 Setpoint Boost		
Range:		Function:
		Set the desired overpressure/temperature in percentage of setpoint for the pressure (P_{set})/ temperature before entering the sleep mode. If setting for 5%, the boost pressure is $P_{set} \times 1.05$. The negative values can be used for cooling tower control where a negative change is needed.

22-46 Maximum Boost Time		
Range:		Function:
60 s*	[0 - 600 s]	Only to be used when <i>parameter 1-00 Configuration Mode</i> is set for [1] <i>Closed loop</i> , and the integrated PI controller is used for controlling the pressure. Set the maximum time for which boost mode is allowed. If the set time is exceeded, sleep mode is entered, not waiting for the set boost pressure to be reached.

22-47 Sleep Speed [Hz]		
Range:		Function:
0*	[0 - 400.0]	Set the speed below which the frequency converter goes into sleep mode.

22-48 Sleep Delay Time		
Range:		Function:
0 s*	[0 - 3600 s]	Set the delay time that the motor waits before entering sleep mode when the condition to enter sleep mode is met.

22-49 Wake-Up Delay Time		
Range:		Function:
0 s*	[0 - 3600 s]	Set the delay time that the motor waits before waking up from sleep mode when the condition to wake up is met.

4.19.1 22-6* Broken-belt Detection

Use broken-belt detection in both closed-loop systems and open-loop systems for pumps and fans. If the estimated motor torque (current) is below the broken-belt torque (current) value (*parameter 22-61 Broken Belt Torque*), the frequency converter output frequency is above or equal to 15 Hz, and the condition has been active for *parameter 22-62 Broken Belt Delay*, *parameter 22-60 Broken Belt Function* is performed.

22-60 Broken Belt Function		
Option:		Function:
		Select the actions to be performed if the broken-belt condition is detected.
[0] *	Off	

22-60 Broken Belt Function		
Option:		Function:
[1]	Warning	The frequency converter continues to run, but activates <i>warning 95, Broken belt</i> . A frequency converter digital output or a serial communication bus communicates a warning to other equipment.
[2]	Trip	The frequency converter stops running and activates <i>alarm 95, Broken belt</i> . A frequency converter digital output or a serial communication bus communicates an alarm to other equipment.

22-61 Broken Belt Torque		
Range:		Function:
10 %*	[5 - 100 %]	Set the broken-belt torque as a percentage of the rated motor torque.

22-62 Broken Belt Delay		
Range:		Function:
10 s*	[0 - 600 s]	Set the time for which the broken-belt conditions must be active before carrying out the action selected in <i>parameter 22-60 Broken Belt Function</i> .

4.20 Parameters: 30-** Special Features

4.20.1 30-2* Adv. Start Adjust

30-20 High Starting Torque Time [s]		
Range:		Function:
Size related*	[0 - 60 s]	High starting torque time for PM motors in VVC ⁺ mode without feedback.

30-21 High Starting Torque Current [%]		
Range:		Function:
Size related*	[0 - 200.0 %]	High starting torque current for PM motors in VVC ⁺ mode without feedback.

30-22 Locked Rotor Protection		
Option:		Function:
[0] *	Off	
[1]	On	The locked rotor protection for PM motors.

30-23 Locked Rotor Detection Time [s]		
Range:		Function:
0.10 s*	[0.05 - 1 s]	The locked rotor detection time for PM motors.

4.21 Parameters: 32-** Motion Control Basic Settings

32-11 User Unit Denominator		
Range:		Function:
1*	[1 - 65535]	All target positions are made in user units and are converted to quad-counts internally. By selecting scaling units, it is possible to work with any measurement unit (for example mm). This factor consists of a numerator and denominator.

32-12 User Unit Numerator		
Range:		Function:
1*	[1 - 65535]	All target positions are made in user units and are converted to quad-counts internally. By selecting scaling units, it is possible to work with any measurement unit (for example mm). This factor consists of a numerator and denominator.

32-67 Max. Tolerated Position Error		
Range:		Function:
2000000*	[1 - 2147483648]	This parameter defines the maximum error allowed between the actual position and the calculated command position. If the actual error exceeds the value set in this parameter, the position-control-fault alarm is triggered.

32-80 Maximum Allowed Velocity		
Range:		Function:
1500 RPM*	[1 - 30000 RPM]	This parameter defines the maximum velocity in RPM during motion control.

32-81 Motion Ctrl Quick Stop Ramp		
Range:		Function:
1000 ms*	[50 - 3600000 ms]	This parameter defines the quick-stop ramp time from the maximum allowed velocity to 0 for motion control.

4.22 Parameters: 33-** Motion Control Adv. Settings

33-00 Homing Mode		
Select the homing mode.		
Option:	Function:	
[0] *	Not forced	
[1]	Forced manual homing	
[2]	Forced automated homing	

33-01 Home Offset		
Range:	Function:	
0* [-1073741824 - 1073741824]	Use this parameter to set an offset of 0 (home position) compared to the position after homing.	

33-02 Home Ramp Time		
Range:	Function:	
10 ms* [1 - 1000 ms]	This parameter defines the ramp time (in ms) from standstill to the value set in <i>parameter 32-80 Maximum Allowed Velocity</i> .	

33-03 Homing Velocity		
Range:	Function:	
100 RPM* [-1500 - 1500 RPM]	This parameter defines the velocity of homing. It must not exceed the <i>parameter 32-80 Maximum Allowed Velocity</i> .	

33-04 Homing Behaviour		
Option:	Function:	
	Define the behavior when the home switch is found: Reversing without index (0 pulse) search, or forwarding without index search.	
[1] *	Reverse no index	
[3]	Forward no index	

33-41 Negative Software Limit		
Range:	Function:	
-500000* [-1073741824 - 1073741824]	It is only active during positioning and if <i>parameter 33-43 Negative Software Limit Active</i> is set to [1] Active. If it is active and <i>parameter 34-50 Actual Position</i> goes below the value specified in this parameter, a <i>position control fault</i> alarm is reported with the fault reason [5] <i>Neg. SW Limit</i> which is specified in <i>parameter 37-18 Pos. Ctrl Fault Reason</i> . The maximum value is the value specified in <i>parameter 33-42 Positive Software Limit</i> . The default value is the smaller value between -500,000 and <i>parameter 33-42 Positive Software Limit</i> .	

33-42 Positive Software Limit		
Range:	Function:	
500000* [-1073741824 - 1073741824]	It is only active during positioning and the <i>parameter 33-44 Positive Software Limit Active</i> is set to [1] Active. If it is active and <i>parameter 34-50 Actual Position</i> goes below the value specified in this parameter, a <i>position control fault</i> alarm is reported with the fault reason [4] <i>Pos. SW Limit</i> which is specified in <i>parameter 37-18 Pos. Ctrl Fault Reason</i> .	

33-43 Negative Software Limit Active		
Option:	Function:	
[0] *	Inactive	
[1]	Active	When this parameter is set to active, the frequency converter continuously checks whether the target position is below the negative software limit. If it occurs, an error is issued and the frequency converter control is switched off.

33-44 Positive Software Limit Active		
Option:	Function:	
[0] *	Inactive	
[1]	Active	When this parameter is set to active, the frequency converter continuously checks whether the target position is above the positive software limit. If it occurs, an error is issued and the frequency converter control is switched off.

33-47 Target Position Window		
Range:	Function:	
0* [0 - 10000]	Defines the size of the target window with user unit. A position is only viewed as reached when the actual position is within this window.	

4.23 Parameters: 34-*** Motion Control Data Readouts

34-01 PCD 1 Write For Application		
Range:	Function:	
0* [0 - 65535]	Value received in PCD1 of fieldbus telegram.	
34-02 PCD 2 Write For Application		
Range:	Function:	
0* [0 - 65535]	Value received in PCD2 of fieldbus telegram.	
34-03 PCD 3 Write For Application		
Range:	Function:	
0* [0 - 65535]	Value received in PCD3 of fieldbus telegram.	
34-04 PCD 4 Write For Application		
Range:	Function:	
0* [0 - 65535]	Value received in PCD4 of fieldbus telegram.	
34-05 PCD 5 Write For Application		
Range:	Function:	
0* [0 - 65535]	Value received in PCD5 of fieldbus telegram.	
34-06 PCD 6 Write For Application		
Range:	Function:	
0* [0 - 65535]	Value received in PCD6 of fieldbus telegram.	
34-07 PCD 7 Write For Application		
Range:	Function:	
0* [0 - 65535]	Value received in PCD7 of fieldbus telegram.	
34-08 PCD 8 Write For Application		
Range:	Function:	
0* [0 - 65535]	Value received in PCD8 of fieldbus telegram.	
34-09 PCD 9 Write For Application		
Range:	Function:	
0* [0 - 65535]	Value received in PCD9 of fieldbus telegram.	
34-10 PCD 10 Write For Application		
Range:	Function:	
0* [0 - 65535]	Value received in PCD10 of fieldbus telegram.	
34-21 PCD 1 Read For Application		
Range:	Function:	
0* [0 - 65535]	Value sent in PCD1 of fieldbus telegram.	
34-22 PCD 2 Read For Application		
Range:	Function:	
0* [0 - 65535]	Value sent in PCD2 of fieldbus telegram.	

34-23 PCD 3 Read For Application		
Range:	Function:	
0* [0 - 65535]	Value sent in PCD3 of fieldbus telegram.	
34-24 PCD 4 Read For Application		
Range:	Function:	
0* [0 - 65535]	Value sent in PCD4 of fieldbus telegram.	
34-25 PCD 5 Read For Application		
Range:	Function:	
0* [0 - 65535]	Value sent in PCD5 of fieldbus telegram.	
34-26 PCD 6 Read For Application		
Range:	Function:	
0* [0 - 65535]	Value sent in PCD6 of fieldbus telegram.	
34-27 PCD 7 Read For Application		
Range:	Function:	
0* [0 - 65535]	Value sent in PCD7 of fieldbus telegram.	
34-28 PCD 8 Read For Application		
Range:	Function:	
0* [0 - 65535]	Value sent in PCD8 of fieldbus telegram.	
34-29 PCD 9 Read For Application		
Range:	Function:	
0* [0 - 65535]	Value sent in PCD9 of fieldbus telegram.	
34-30 PCD 10 Read For Application		
Range:	Function:	
0* [0 - 65535]	Value sent in PCD10 of fieldbus telegram.	
34-50 Actual Position		
Range:	Function:	
0* [-1073741824 - 1073741824]	The actual position in user unit.	
34-56 Track Error		
Range:	Function:	
0* [-2147483647 - 2147483647]	Readout of the error between calculated command position and actual position in user unit.	

4.24 Parameters: 37-*** Application Settings

37-00 Application Mode		
Option:	Function:	
[0] *	Drive mode	
[2]	Position Control	

37-01 Pos. Feedback Source		
Option:	Function:	
[0] *	24V Encoder	Select the position feedback source.

37-02 Pos. Target		
Range:	Function:	
0* [-1073741824 - 1073741824]	If <i>parameter 37-03 Pos. Type</i> is set to [0] <i>Absolute</i> , the target position is an absolute position (relative to home position). If the <i>parameter 37-03 Pos. Type</i> is set to [1] <i>Relative</i> and the last position was obtained through jogging, the target position is relative to that position. If the last position was reached as a result of a positioning command, then the target position is relative to the last target position no matter whether it was reached or not.	

37-03 Pos. Type		
This parameter defines the target position type.		
Option:	Function:	
[0] *	Absolute	
[1]	Relative	

37-04 Pos. Velocity		
Range:	Function:	
100 RPM*	[1 - 30000 RPM]	Defines the velocity during positioning. The maximum value must not exceed the value specified in <i>parameter 32-80 Maximum Allowed Velocity</i> .

37-05 Pos. Ramp Up Time		
Range:	Function:	
5000 ms*	[50 - 100000 ms]	Define the time in milliseconds that it takes to ramp from standstill to <i>parameter 32-80 Maximum Allowed Velocity</i> .

37-06 Pos. Ramp Down Time		
Range:	Function:	
5000 ms*	[50 - 100000 ms]	It is defined as the time in milliseconds that it takes to ramp from <i>parameter 32-80 Maximum Allowed Velocity</i> to standstill.

37-07 Pos. Auto Brake Ctrl		
When the automatic brake control function is disabled, the frequency converter controls the application also at standstill. When the automatic brake control function is enabled, the mechanical brake is automatically activated every time the application is at standstill for a time period specified in <i>parameter 37-08 Pos. Hold Delay</i> .		
Option:	Function:	
[0]	Disable	
[1] *	Enable	

37-08 Pos. Hold Delay		
Range:	Function:	
0 ms* [0 - 10000 ms]	To be used with the automatic brake control function. The hold delay is a waiting period in which the brake is not activated even though the application is at standstill.	

37-09 Pos. Coast Delay		
Range:	Function:	
200 ms* [0 - 1000 ms]	To be used with the automatic brake control function. The coast delay is the delay from activating the mechanical brake to disabling the controller and coasting the frequency converter.	

37-10 Pos. Brake Delay		
Range:	Function:	
200 ms* [0 - 1000 ms]	To be used with the automatic brake control function. The brake delay is the delay after activating the control and magnetizing the motor before opening the brake.	

37-11 Pos. Brake Wear Limit		
Range:	Function:	
0* [0 - 1073741824]	Set this parameter to a positive value. While the brake is activated, if the frequency converter moves more than the limit in user unit set in this parameter, the frequency converter reports an alarm <i>POSITION CTRL FAULT</i> with fault reason <i>Brake Wear Limit Exceeded</i> .	

37-12 Pos. PID Anti Windup		
Configure whether to enable the anti-windup of positioning PID.		
Option:	Function:	
[0]	Disable	
[1] *	Enable	

37-13 Pos. PID Output Clamp		
Range:		Function:
1000*	[1 - 10000]	This parameter clamps the total output of the PID. A setting of 1000 corresponds to 100% of <i>parameter 32-80 Maximum Allowed Velocity</i> .

37-14 Pos. Ctrl. Source		
Select the control source for positioning control.		
Option:		Function:
[0] *	DI	
[1]	FieldBus	

37-15 Pos. Direction Block		
Use this parameter to configure whether to block a direction, and the direction to be blocked.		
Option:		Function:
[0] *	No Blocking	
[1]	Block Reverse	
[2]	Block Forward	

37-17 Pos. Ctrl Fault Behaviour		
This parameter determines the behavior of the frequency converter after a fault is detected.		
Option:		Function:
[0] *	Ramp Down&Brake	
[1]	Brake Directly	

37-18 Pos. Ctrl Fault Reason		
READ-ONLY PARAMETER: The current fault reason of the alarm. <i>POSITION CTRL FAULT</i> is shown in this parameter.		
Option:		Function:
[0] *	No Fault	
[1]	Homing Needed	
[2]	Pos. HW Limit	
[3]	Neg. HW Limit	
[4]	Pos. SW Limit	
[5]	Neg. SW Limit	
[7]	Brake Wear Limit	
[8]	Quick Stop	
[9]	PID Error Too Big	
[12]	Rev. Operation	
[13]	Fwd. Operation	
[20]	Can not find home position	

37-19 Pos. New Index		
Range:		Function:
0*	[0 - 255]	The currently latched index number.

5 Parameter Lists

5.1 Introduction

5.1.1 Default Settings

Changes during operation

True means that the parameter can be changed while the frequency converter is in operation, and false means that the frequency converter must be stopped before a change can be made.

4-set-up

All set-ups: The parameter can be set individually in each of the 4 set-ups, that is 1 single parameter can have 4 different data values.

1 set-up: Data value is the same in all set-ups.

Data type	Description	Type
2	Integer 8	Int8
3	Integer 16	Int16
4	Integer 32	Int32
5	Unsigned 8	UInt8
6	Unsigned 16	UInt16
7	Unsigned 32	UInt32
9	Visible String	VisStr
33	Normalized value 2 bytes	N2
35	Bit sequence of 16 boolean variables	V2
54	Time difference w/o date	TimD

Table 5.1 Data Type

5.1.2 Conversion

The various attributes of each parameter are shown in *Factory Setting*. Parameter values are transferred as whole numbers only. Conversion factors are therefore used to transfer decimals.

Parameter 4-12 Motor Speed Low Limit [Hz] has a conversion factor of 0.1. To set the minimum frequency to 10 Hz, transfer the value 100. A conversion factor of 0.1 means that the value transferred is multiplied by 0.1. The value 100 is therefore read as 10.0.

Examples:

0 s⇒conversion index 0

0.00 s⇒conversion index -2

0 ms⇒conversion index -3

0.00 ms⇒conversion index -5

Conversion index	Conversion factor
100	1
75	3600000
74	3600
70	60
67	1/60
6	1000000
5	100000
4	10000
3	1000
2	100
1	10
0	1
-1	0.1
-2	0.01
-3	0.001
-4	0.0001
-5	0.00001
-6	0.000001
-7	0.0000001

Table 5.2 Conversion Table

5.1.3 Active/Inactive Parameters in Different Drive Control Modes

+ indicates that the parameter is active in the mode.
 - indicates that the parameter is inactive in the mode.

Parameter 1-10 Motor Construction	AC motor	
	U/f mode	VVC ⁺
Parameter 1-01 Motor Control Principle		
Parameter 1-00 Configuration Mode		
[0] Speed Open Loop	+	+
[1] Speed Closed Loop	-	+
[2] Torque Closed Loop	-	+
[3] Process	+	+
[4] Torque Open Loop	-	+
[7] Ext. PID Open Loop	+	+
Parameter 1-03 Torque Characteristics	-	+ ^{1, 2, 3)}
Parameter 1-06 Clockwise Direction	+	+
Parameter 1-20 Motor Power [kW] (parameter 0-03 Regional Settings = [0] International)	+	+
Parameter 1-22 Motor Voltage	+	+
Parameter 1-23 Motor Frequency	+	+
Parameter 1-24 Motor Current	+	+
Parameter 1-25 Motor Nominal Speed	+	+
Parameter 1-29 Automatic Motor Adaptation (AMA)	+	+
Parameter 1-30 Stator Resistance (Rs)	+	+
Parameter 1-33 Stator Leakage Reactance (X1)	+	+
Parameter 1-35 Main Reactance (Xh)	+	+
Parameter 1-39 Motor Poles	+	+

Table 5.3 Active/Inactive Parameters

- 1) Constant torque
- 2) Variable torque
- 3) AEO

Parameter 1-10 Motor Construction	AC motor	
	U/f mode	VVC ⁺
Parameter 1-01 Motor Control Principle		
Parameter 1-50 Motor Magnetisation at Zero Speed	-	+
Parameter 1-52 Min Speed Normal Magnetising [Hz]	-	+
Parameter 1-55 U/f Characteristic - U	+	-
Parameter 1-56 U/f Characteristic - F	+	-
Parameter 1-60 Low Speed Load Compensation	-	+
Parameter 1-61 High Speed Load Compensation	-	+
Parameter 1-62 Slip Compensation	-	+ ⁴⁾
Parameter 1-63 Slip Compensation Time Constant	+ ⁵⁾	+
Parameter 1-64 Resonance Damping	+	+
Parameter 1-65 Resonance Damping Time Constant	+	+
Parameter 1-71 Start Delay	+	+
Parameter 1-72 Start Function	+	+
Parameter 1-73 Flying Start	-	+
Parameter 1-75 Start Speed [Hz]	-	+
Parameter 1-76 Start Current	-	+

Table 5.4 Active/Inactive Parameters

- 4) Not used when parameter 1-03 Torque Characteristics = VT.
- 5) Part of resonance damping.

Parameter 1-10 Motor Construction	AC motor	
	U/f mode	VVC ⁺
Parameter 1-01 Motor Control Principle		
Parameter 1-80 Function at Stop	+	+
Parameter 1-82 Min Speed for Function at Stop [Hz]	+	+
Parameter 1-90 Motor Thermal Protection	+	+
Parameter 1-93 Thermistor Resource	+	+
Parameter 2-00 DC Hold Current	+	+
Parameter 2-01 DC Brake Current	+	+
Parameter 2-02 DC Braking Time	+	+
Parameter 2-04 DC Brake Cut In Speed [Hz]	+	+
Parameter 2-10 Brake Function	+ ⁶⁾	+
Parameter 2-11 Brake Resistor (ohm)	+	+
Parameter 2-12 Brake Power Limit (kW)	+	+
Parameter 2-16 AC brake Max. Current	-	+
Parameter 2-17 Over-voltage Control	+	+
Parameter 2-19 Over-voltage Gain	+	+
Parameter 2-20 Release Brake Current	+	+
Parameter 2-22 Activate Brake Speed [Hz]	+	+

Table 5.5 Active/Inactive Parameters

6) Not AC brake

5.2 Parameter Lists

5.2.1 0-** Operation and Display

Parameter #	Parameter description	Default value	4 set-up	Change during operation	Conversion index	Type
0-0* Basic Settings						
0-01	Language	[0] English	1 set-up	TRUE	-	UInt8
0-03	Regional Settings	[0] International	1 set-up	FALSE	-	UInt8
0-04	Operating State at Power-up	[0] Resume	All set-ups	TRUE	-	UInt8
0-06	GridType	Size Related	1 set-up	FALSE	-	UInt8
0-07	Auto DC Braking	[1] On	1 set-up	FALSE	-	UInt8
0-1* Set-up Operations						
0-10	Active Set-up	[1] Set-up 1	1 set-up	TRUE	-	UInt8
0-11	Programming Set-up	[9] Active Set-up	1 set-up	TRUE	-	UInt8
0-12	Link Setups	[20] Linked	All set-ups	FALSE	-	UInt8
0-14	Readout: Edit Set-ups / Channel	0 N/A	All set-ups	TRUE	0	Int32
0-16	Application Selection	[0] None	1 set-up	FALSE	-	UInt8
0-2* LCP Display						
0-20	Display Line 1.1 Small	1602	All set-ups	TRUE	-	UInt16
0-21	Display Line 1.2 Small	1614	All set-ups	TRUE	-	UInt16
0-22	Display Line 1.3 Small	1610	All set-ups	TRUE	-	UInt16
0-23	Display Line 2 Large	1613	All set-ups	TRUE	-	UInt16
0-24	Display Line 3 Large	1502	All set-ups	TRUE	-	UInt16
0-3* LCP Custom Readout						
0-30	Custom Readout Unit	[1] %	1 set-up	TRUE	-	UInt8
0-31	Custom Readout Min Value	0 CustomReadoutUnit	1 set-up	TRUE	-2	Int32
0-32	Custom Readout Max Value	100 CustomReadoutUnit	1 set-up	TRUE	-2	Int32
0-37	Display Text 1	[]	1 set-up	TRUE	0	VisStr[21]
0-38	Display Text 2	[]	1 set-up	TRUE	0	VisStr[26]
0-39	Display Text 3	[]	1 set-up	TRUE	0	VisStr[26]
0-4* LCP Keypad						
0-40	[Hand on] Key on LCP	[1] Enabled	All set-ups	TRUE	-	UInt8
0-42	[Auto on] Key on LCP	[1] Enabled	All set-ups	TRUE	-	UInt8
0-44	[Off/Reset] Key on LCP	[1] Enabled	All set-ups	TRUE	-	UInt8
0-5* Copy/Save						
0-50	LCP Copy	[0] No copy	1 set-up	FALSE	-	UInt8
0-51	Set-up Copy	[0] No copy	1 set-up	FALSE	-	UInt8
0-6* Password						
0-60	Main Menu Password	0 N/A	1 set-up	TRUE	0	UInt16

5.2.2 1-** Load and Motor

Parameter #	Parameter description	Default value	4 set-up	Change during operation	Conversion index	Type
1-0* General Settings						
1-00	Configuration Mode	[0] Open Loop	All set-ups	TRUE	-	UInt8
1-01	Motor Control Principle	[1] VVC+	All set-ups	FALSE	-	UInt8
1-03	Torque Characteristics	[0] Constant torque	All set-ups	FALSE	-	UInt8
1-06	Clockwise Direction	[0] Normal	1 set-up	FALSE	-	UInt8
1-08	Motor Control Bandwidth	Size Related	1 set-up	FALSE	-	UInt8
1-1* Motor Selection						

Parameter #	Parameter description	Default value	4 set-up	Change during operation	Conversion index	Type
1-10	Motor Construction	[0] Asynchron	1 set-up	FALSE	-	Uint8
1-14	Damping Gain	120 %	All set-ups	TRUE	0	Int16
1-15	Low Speed Filter Time Const.	Size Related	All set-ups	TRUE	-2	Uint16
1-16	High Speed Filter Time Const.	Size Related	All set-ups	TRUE	-2	Uint16
1-17	Voltage filter time const.	Size Related	All set-ups	TRUE	-3	Uint16
1-2* Motor Data						
1-20	Motor Power	Size Related	All set-ups	FALSE	-	Uint8
1-22	Motor Voltage	Size Related	All set-ups	FALSE	0	Uint16
1-23	Motor Frequency	Size Related	All set-ups	FALSE	0	Uint16
1-24	Motor Current	Size Related	All set-ups	FALSE	-2	Uint32
1-25	Motor Nominal Speed	Size Related	All set-ups	FALSE	67	Uint16
1-26	Motor Cont. Rated Torque	Size Related	All set-ups	FALSE	-1	Uint32
1-29	Automatic Motor Adaption (AMA)	[0] Off	All set-ups	FALSE	-	Uint8
1-3* Adv. Motor Data I						
1-30	Stator Resistance (Rs)	Size Related	All set-ups	FALSE	-3	Uint32
1-31	Rotor Resistance (Rr)	Size Related	All set-ups	FALSE	-3	Uint32
1-33	Stator Leakage Reactance (X1)	Size Related	All set-ups	FALSE	-3	Uint32
1-35	Main Reactance (Xh)	Size Related	All set-ups	FALSE	-2	Uint32
1-37	d-axis Inductance (Ld)	Size Related	All set-ups	FALSE	-6	Int32
1-38	q-axis Inductance (Lq)	Size Related	All set-ups	FALSE	-6	Int32
1-39	Motor Poles	Size Related	All set-ups	FALSE	0	Uint8
1-4* Adv. Motor Data II						
1-40	Back EMF at 1000 RPM	Size Related	All set-ups	FALSE	0	Uint16
1-42	Motor Cable Length	50 m	All set-ups	FALSE	0	Uint8
1-43	Motor Cable Length Feet	164 ft	All set-ups	FALSE	0	Uint16
1-44	d-axis Inductance Sat. (LdSat)	Size Related	All set-ups	FALSE	-6	Int32
1-45	q-axis Inductance Sat. (LqSat)	Size Related	All set-ups	FALSE	-6	Int32
1-46	Position Detection Gain	100 %	All set-ups	TRUE	0	Uint16
1-48	Current at Min Inductance for d-axis	100 %	All set-ups	FALSE	0	Int16
1-49	Current at Min Inductance for q-axis	100 %	All set-ups	FALSE	0	Uint16
1-5* Load Indep. Setting						
1-50	Motor Magnetisation at Zero Speed	100 %	All set-ups	TRUE	0	Uint16
1-52	Min Speed Normal Magnetising [Hz]	1 Hz	All set-ups	TRUE	-1	Uint16
1-55	U/f Characteristic - U	Size Related	All set-ups	FALSE	-1	Uint16
1-56	U/f Characteristic - F	Size Related	All set-ups	FALSE	-1	Uint16
1-6* Load Depen. Setting						
1-60	Low Speed Load Compensation	100 %	All set-ups	TRUE	0	Int16
1-61	High Speed Load Compensation	100 %	All set-ups	TRUE	0	Int16
1-62	Slip Compensation	Size Related	All set-ups	TRUE	0	Int16
1-63	Slip Compensation Time Constant	0.1 s	All set-ups	TRUE	-2	Uint16
1-64	Resonance Dampening	100 %	All set-ups	TRUE	0	Uint16
1-65	Resonance Dampening Time Constant	0.005 s	All set-ups	TRUE	-3	Uint16
1-66	Min. Current at Low Speed	50 %	All set-ups	TRUE	0	Uint32
1-7* Start Adjustments						
1-70	PM Start Mode	[0] Rotor Detection	All set-ups	TRUE	-	Uint8
1-71	Start Delay	0 s	All set-ups	TRUE	-1	Uint8

Parameter #	Parameter description	Default value	4 set-up	Change during operation	Conversion index	Type
1-72	Start Function	[2] Coast/delay time	All set-ups	TRUE	-	Uint8
1-73	Flying Start	[0] Disabled	All set-ups	TRUE	-	Uint8
1-75	Start Speed [Hz]	Size Related	All set-ups	TRUE	-1	Uint16
1-76	Start Current	Size Related	All set-ups	TRUE	-2	Uint32
1-78	Compressor Start Max Speed [Hz]	0 Hz	All set-ups	TRUE	-1	Uint16
1-79	Compressor Start Max Time to Trip	5 s	All set-ups	TRUE	-1	Uint8
1-8* Stop Adjustments						
1-80	Function at Stop	[0] Coast	All set-ups	TRUE	-	Uint8
1-82	Min Speed for Function at Stop [Hz]	0 Hz	All set-ups	TRUE	-1	Uint16
1-83	Precise Stop Function	[0] Precise ramp stop	All set-ups	FALSE	-	Uint8
1-84	Precise Stop Counter Value	100000 N/A	All set-ups	TRUE	0	Uint32
1-85	Precise Stop Speed Compensation Delay	10 ms	All set-ups	TRUE	-3	Uint8
1-88	AC Brake Gain	1.4 N/A	All set-ups	TRUE	-1	Uint16
1-9* Motor Temperature						
1-90	Motor Thermal Protection	[0] No protection	All set-ups	TRUE	-	Uint8
1-93	Thermistor Source	[0] None	All set-ups	FALSE	-	Uint8

5.2.3 2-** Brakes

Parameter #	Parameter description	Default value	4 set-up	Change during operation	Conversion index	Type
2-0* DC-Brake						
2-00	DC Hold/Motor Preheat Current	50 %	All set-ups	TRUE	0	Uint16
2-01	DC Brake Current	50 %	All set-ups	TRUE	0	Uint16
2-02	DC Braking Time	10 s	All set-ups	TRUE	-1	Uint16
2-04	DC Brake Cut In Speed	0 Hz	All set-ups	TRUE	-1	Uint16
2-06	Parking Current	100 %	All set-ups	TRUE	0	Uint16
2-07	Parking Time	3 s	All set-ups	TRUE	-1	Uint16
2-1* Brake Energy Funct.						
2-10	Brake Function	[0] Off	All set-ups	TRUE	-	Uint8
2-11	Brake Resistor (ohm)	Size Related	All set-ups	FALSE	-1	Uint16
2-12	Brake Power Limit (kW)	Size Related	All set-ups	TRUE	0	Uint32
2-14	Brake voltage reduce	0 V	All set-ups	FALSE	0	uint16
2-16	AC Brake, Max current	100 %	All set-ups	TRUE	-1	Uint16
2-17	Over-voltage Control	[0] Disabled	All set-ups	TRUE	-	Uint8
2-19	Over-voltage Gain	100 %	All set-ups	TRUE	0	Uint16
2-2* Mechanical Brake						
2-20	Release Brake Current	0 A	All set-ups	TRUE	-2	Uint32
2-22	Activate Brake Speed [Hz]	0 Hz	All set-ups	TRUE	-1	Uint16
2-23	Activate Brake Delay	0 s	All set-ups	TRUE	-1	Uint8

5.2.4 3-** Reference/Ramps

Parameter #	Parameter description	Default value	4 set-up	Change during operation	Conversion index	Type
3-0* Reference Limits						
3-00	Reference Range	[0] Min - Max	All set-ups	TRUE	-	Uint8
3-01	Reference/Feedback Unit	Size Related	All set-ups	TRUE	-	Uint8
3-02	Minimum Reference	0 ReferenceFeed-backUnit	All set-ups	TRUE	-3	Int32
3-03	Maximum Reference	Size Related	All set-ups	TRUE	-3	Int32
3-04	Reference Function	[0] Sum	All set-ups	TRUE	-	Uint8
3-1* References						
3-10	Preset Reference	0 %	All set-ups	TRUE	-2	Int16
3-11	Jog Speed [Hz]	5 Hz	All set-ups	TRUE	-1	Uint16
3-12	Catch up/slow Down Value	0 %	All set-ups	TRUE	-2	Int16
3-14	Preset Relative Reference	0 %	All set-ups	TRUE	-2	Int16
3-15	Reference 1 Source	[1] Analog Input 53	All set-ups	TRUE	-	Uint8
3-16	Reference 2 Source	[0] No function	All set-ups	TRUE	-	Uint8
3-17	Reference 3 Source	[11] Local bus reference	All set-ups	TRUE	-	Uint8
3-18	Relative Scaling Reference Resource	[0] No function	All set-ups	TRUE	-	Uint8
3-4* Ramp 1						
3-40	Ramp 1 Type	[0] Linear	All set-ups	TRUE	-	Uint8
3-41	Ramp 1 Ramp Up Time	Size Related	All set-ups	TRUE	-2	Uint32
3-42	Ramp 1 Ramp Down Time	Size Related	All set-ups	TRUE	-2	Uint32
3-5* Ramp 2						
3-50	Ramp 2 Type	[0] Linear	All set-ups	TRUE	-	Uint8
3-51	Ramp 2 Ramp Up Time	Size Related	All set-ups	TRUE	-2	Uint32
3-52	Ramp 2 Ramp Down Time	Size Related	All set-ups	TRUE	-2	Uint32
3-6* Ramp 3						
3-60	Ramp 3 Type	[0] Linear	All set-ups	TRUE	-	Uint8
3-61	Ramp 3 Ramp up Time	Size Related	All set-ups	TRUE	-2	Uint32
3-62	Ramp 3 Ramp down Time	Size Related	All set-ups	TRUE	-2	Uint32
3-7* Ramp 4						
3-70	Ramp 4 Type	[0] Linear	All set-ups	TRUE	-	Uint8
3-71	Ramp 4 Ramp up Time	Size Related	All set-ups	TRUE	-2	Uint32
3-72	Ramp 4 Ramp Down Time	Size Related	All set-ups	TRUE	-2	Uint32
3-8* Other Ramps						
3-80	Jog Ramp Time	Size Related	All set-ups	TRUE	-2	Uint32
3-81	Quick Stop Ramp Time	Size Related	1 set-up	TRUE	-2	Uint32
3-9* Digital Pot.Meter						
3-90	Step Size	0.10 %	All set-ups	TRUE	-2	Uint16
3-92	Power Restore	[0] Off	All set-ups	TRUE	-	Uint8
3-93	Maximum Limit	100 %	All set-ups	TRUE	0	Int16
3-94	Minimum Limit	-100 %	All set-ups	TRUE	0	Int16
3-95	Ramp Delay	1000 ms	All set-ups	TRUE	-3	uint32
3-96	Maximum Limit Switch Reference	25 %	All set-ups	TRUE	0	Int16

5.2.5 4-** Limits/Warnings

Parameter #	Parameter description	Default value	4 set-up	Change during operation	Conversion index	Type
4-1* Motor Limits						
4-10	Motor Speed Direction	[0] Clockwise	All set-ups	FALSE	-	Uint8
4-12	Motor Speed Low Limit [Hz]	0 Hz	All set-ups	FALSE	-1	Uint16
4-14	Motor Speed High Limit [Hz]	65 Hz	All set-ups	FALSE	-1	Uint16
4-16	Torque Limit Motor Mode	Size Related	All set-ups	TRUE	0	Uint16
4-17	Torque Limit Generator Mode	100 %	All set-ups	TRUE	0	Uint16
4-18	Current Limit	Size Related	All set-ups	TRUE	0	Uint16
4-19	Max Output Frequency	Size Related	All set-ups	FALSE	-1	Uint16
4-2* Limit Factors						
4-20	Torque Limit Factor Source	[0] No function	All set-ups	TRUE	-	Uint8
4-21	Speed Limit Factor Source	[0] No function	All set-ups	TRUE	-	Uint8
4-22	Break Away Boost	[0] Off	All set-ups	FALSE	-	Uint8
4-3* Motor Fb Monitor						
4-30	Motor Feedback Loss Function	[2] Trip	All set-ups	TRUE	-	Uint8
4-31	Motor Feedback Speed Error	20 Hz	All set-ups	TRUE	0	Uint16
4-32	Motor Feedback Loss Timeout	0.05 s	All set-ups	TRUE	-2	Uint16
4-4* Adj. Warnings 2						
4-40	Warning Freq. Low	Size Related	All set-ups	TRUE	-1	uint16
4-41	Warning Freq. High	Size Related	All set-ups	TRUE	-1	uint16
4-42	Adjustable Temperature Warning	0 N/A	All set-ups	TRUE	0	Uint8
4-5* Adj. Warnings						
4-50	Warning Current Low	0 A	All set-ups	TRUE	-2	Uint32
4-51	Warning Current High	Size Related	All set-ups	TRUE	-2	Uint32
4-54	Warning Reference Low	-4999 N/A	All set-ups	TRUE	-3	Int32
4-55	Warning Reference High	4999 N/A	All set-ups	TRUE	-3	Int32
4-56	Warning Feedback Low	-4999 ProcessCtrlUnit	All set-ups	TRUE	-3	Int32
4-57	Warning Feedback High	4999 ProcessCtrlUnit	All set-ups	TRUE	-3	Int32
4-58	Missing Motor Phase Function	[1] On	All set-ups	FALSE	-	Uint8
4-6* Speed Bypass						
4-61	Bypass Speed From [Hz]	0 Hz	All set-ups	TRUE	-1	Uint16
4-63	Bypass Speed To [Hz]	0 Hz	All set-ups	TRUE	-1	Uint16

5.2.6 5-** Digital In/Out

Parameter #	Parameter description	Default value	4 set-up	Change during operation	Conversion index	Type
5-0* Digital I/O mode						
5-00	Digital I/O Mode	[0] PNP	1 set-up	FALSE	-	Uint8
5-01	Terminal 27 Mode	[0] Input	All set-ups	TRUE	-	Uint8
5-1* Digital Inputs						
5-10	Terminal 18 Digital Input	[8] Start	All set-ups	TRUE	-	Uint8
5-11	Terminal 19 Digital Input	[10] Reversing	All set-ups	TRUE	-	Uint8
5-12	Terminal 27 Digital Input	Size Related	All set-ups	TRUE	-	Uint8
5-13	Terminal 29 Digital Input	[14] Jog	All set-ups	TRUE	-	Uint8
5-14	Terminal 32 Digital Input	[0] No operation	All set-ups	TRUE	-	Uint8
5-15	Terminal 33 Digital Input	[16] Preset ref bit 0	All set-ups	TRUE	-	Uint8
5-19	Terminal 37/38 Safe Torque Off	[1] Safe Torque Off Alarm	1 set-up	TRUE	-	Uint8

Parameter #	Parameter description	Default value	4 set-up	Change during operation	Conversion index	Type
5-3* Digital Outputs						
5-30	Terminal 27 Digital Output	[0] No operation	All set-ups	TRUE	-	Uint8
5-34	On Delay, Digital Output	0.01 s	All set-ups	TRUE	-2	uint16
5-35	Off Delay, Digital Output	0.01 s	All set-ups	TRUE	-2	uint16
5-4* Relay						
5-40	Function Relay	Size Related	All set-ups	TRUE	-	Uint8
5-41	On Delay, Relay	0.01 s	All set-ups	TRUE	-2	Uint16
5-42	Off Delay, Relay	0.01 s	All set-ups	TRUE	-2	Uint16
5-5* Pulse Input						
5-50	Term. 29 Low Frequency	4 Hz	All set-ups	TRUE	0	Uint32
5-51	Term. 29 High Frequency	32000 Hz	All set-ups	TRUE	0	Uint32
5-52	Term. 29 Low Ref./Feedb. Value	0 N/A	All set-ups	TRUE	-3	Int32
5-53	Term. 29 High Ref./Feedb. Value	Size Related	All set-ups	TRUE	-3	Int32
5-55	Term. 33 Low Frequency	4 Hz	All set-ups	TRUE	0	Uint32
5-56	Term. 33 High Frequency	32000 Hz	All set-ups	TRUE	0	Uint32
5-57	Term. 33 Low Ref./Feedb. Value	0 N/A	All set-ups	TRUE	-3	Int32
5-58	Term. 33 High Ref./Feedb. Value	Size Related	All set-ups	TRUE	-3	Int32
5-6* Pulse Output						
5-60	Terminal 27 Pulse Output Variable	[0] No operation	All set-ups	TRUE	-	Uint8
5-62	Pulse Output Max Freq 27	5000 Hz	All set-ups	TRUE	0	Uint32
5-7* 24V Encoder Input						
5-70	Term 32/33 Pulses Per Revolution	1024 N/A	All set-ups	FALSE	0	Uint16
5-71	Term 32/33 Encoder Direction	[0] Clockwise	All set-ups	FALSE	-	Uint8
5-9* Bus Controlled						
5-90	Digital & Relay Bus Control	0 N/A	All set-ups	TRUE	0	Uint32
5-93	Pulse Out 27 Bus Control	0 %	All set-ups	TRUE	-2	Uint16
5-94	Pulse Out 27 Timeout Preset	0 %	1 set-up	TRUE	-2	Uint16

5.2.7 6-** Analog In/Out

Parameter #	Parameter description	Default value	4 set-up	Change during operation	Conversion index	Type
6-0* Analog I/O Mode						
6-00	Live Zero Timeout Time	10 s	All set-ups	TRUE	0	Uint8
6-01	Live Zero Timeout Function	[0] Off	All set-ups	TRUE	-	Uint8
6-1* Analog Input 53						
6-10	Terminal 53 Low Voltage	0.07 V	All set-ups	TRUE	-2	Uint16
6-11	Terminal 53 High Voltage	10 V	All set-ups	TRUE	-2	Uint16
6-14	Terminal 53 Low Ref./Feedb. Value	0 N/A	All set-ups	TRUE	-3	Int32
6-15	Terminal 53 High Ref./Feedb. Value	Size Related	All set-ups	TRUE	-3	Int32
6-16	Terminal 53 Filter Time Constant	0.01 s	All set-ups	TRUE	-2	Uint16
6-18	Terminal 53 Digital Input	[0] No operation	All set-ups	TRUE	-	Uint8
6-19	Terminal 53 mode	[1] Voltage mode	1 set-up	TRUE	-	Uint8
6-2* Analog Input 54						
6-20	Terminal 54 Low Voltage	0.07 V	All set-ups	TRUE	-2	Uint16
6-21	Terminal 54 High Voltage	10 V	All set-ups	TRUE	-2	Uint16
6-22	Terminal 54 Low Current	4 mA	All set-ups	TRUE	-5	Uint16
6-23	Terminal 54 High Current	20 mA	All set-ups	TRUE	-5	Uint16

Parameter #	Parameter description	Default value	4 set-up	Change during operation	Conversion index	Type
6-24	Terminal 54 Low Ref./Feedb. Value	0 N/A	All set-ups	TRUE	-3	Int32
6-25	Terminal 54 High Ref./Feedb. Value	Size Related	All set-ups	TRUE	-3	Int32
6-26	Terminal 54 Filter Time Constant	0.01 s	All set-ups	TRUE	-2	UInt16
6-29	Terminal 54 mode	[1] Voltage mode	1 set-up	TRUE	-	UInt8
6-9* Analog/Digital Output 42						
6-90	Terminal 42 Mode	[0] 0-20 mA	All set-ups	TRUE	-	UInt8
6-91	Terminal 42 Analog Output	[0] No operation	All set-ups	TRUE	-	UInt8
6-92	Terminal 42 Digital Output	[0] No operation	All set-ups	TRUE	-	UInt8
6-93	Terminal 42 Output Min Scale	0 %	All set-ups	TRUE	-2	UInt16
6-94	Terminal 42 Output Max Scale	100 %	All set-ups	TRUE	-2	UInt16
6-96	Terminal 42 Output Bus Control	0 N/A	All set-ups	TRUE	0	UInt16
6-98	Drive Type	0 N/A	1 set-up	FALSE	0	UInt8

5.2.8 7-** Controllers

Parameter #	Parameter description	Default value	4 set-up	Change during operation	Conversion index	Type
7-0* Speed PID Ctrl.						
7-00	Speed PID Feedback Source	[20] None	All set-ups	FALSE	-	UInt8
7-02	Speed PID Proportional Gain	0.015 N/A	All set-ups	TRUE	-3	UInt16
7-03	Speed PID Integral Time	8 ms	All set-ups	TRUE	-4	UInt32
7-04	Speed PID Differentiation Time	30 ms	All set-ups	TRUE	-4	UInt16
7-05	Speed PID Diff. Gain Limit	5 N/A	All set-ups	TRUE	-1	UInt16
7-06	Speed PID Lowpass Filter Time	10 ms	All set-ups	TRUE	-4	UInt16
7-07	Speed PID Feedback Gear Ratio	1 N/A	All set-ups	FALSE	-4	UInt32
7-08	Speed PID Feed Forward Factor	0 %	All set-ups	FALSE	0	UInt16
7-1* Torque PID Ctrl.						
7-12	Torque PID Proportional Gain	100 %	All set-ups	TRUE	0	UInt16
7-13	Torque PID Integration Time	0.020 s	All set-ups	TRUE	-3	UInt16
7-2* Process Ctrl. Feedb						
7-20	Process CL Feedback 1 Resource	[0] No function	All set-ups	TRUE	-	UInt8
7-22	Process CL Feedback 2 Resource	[0] No function	All set-ups	TRUE	-	UInt8
7-3* Process PID Ctrl.						
7-30	Process PID Normal/ Inverse Control	[0] Normal	All set-ups	TRUE	-	UInt8
7-31	Process PID Anti Windup	[1] On	All set-ups	TRUE	-	UInt8
7-32	Process PID Start Speed	0 RPM	All set-ups	TRUE	67	UInt16
7-33	Process PID Proportional Gain	0.01 N/A	All set-ups	TRUE	-2	UInt16
7-34	Process PID Integral Time	9999 s	All set-ups	TRUE	-2	UInt32
7-35	Process PID Differentiation Time	0 s	All set-ups	TRUE	-2	UInt16
7-36	Process PID Diff. Gain Limit	5 N/A	All set-ups	TRUE	-1	UInt16
7-38	Process PID Feed Forward Factor	0 %	All set-ups	TRUE	0	UInt16
7-39	On Reference Bandwidth	5 %	All set-ups	TRUE	0	UInt8
7-4* Adv. Process PID I						
7-40	Process PID I-part Reset	[0] No	All set-ups	TRUE	-	UInt8
7-41	Process PID Output Neg. Clamp	-100 %	All set-ups	TRUE	0	Int16
7-42	Process PID Output Pos. Clamp	100 %	All set-ups	TRUE	0	Int16
7-43	Process PID Gain Scale at Min. Ref.	100 %	All set-ups	TRUE	0	Int16
7-44	Process PID Gain Scale at Max. Ref.	100 %	All set-ups	TRUE	0	Int16

Parameter #	Parameter description	Default value	4 set-up	Change during operation	Conversion index	Type
7-45	Process PID Feed Fwd Resource	[0] No function	All set-ups	TRUE	-	Uint8
7-46	Process PID Feed Fwd Normal/ Inv. Ctrl.	[0] Normal	All set-ups	TRUE	-	Uint8
7-48	PCD Feed Forward	0 N/A	All set-ups	TRUE	0	Uint16
7-49	Process PID Output Normal/ Inv. Ctrl.	[0] Normal	All set-ups	TRUE	-	Uint8
7-5* Adv. Process PID II						
7-50	Process PID Extended PID	[1] Enabled	All set-ups	TRUE	-	Uint8
7-51	Process PID Feed Fwd Gain	1 N/A	All set-ups	TRUE	-2	Uint16
7-52	Process PID Feed Fwd Ramp up	0.01 s	All set-ups	TRUE	-2	Uint32
7-53	Process PID Feed Fwd Ramp down	0.01 s	All set-ups	TRUE	-2	Uint32
7-56	Process PID Ref. Filter Time	0.001 s	All set-ups	TRUE	-3	Uint16
7-57	Process PID Fb. Filter Time	0.001 s	All set-ups	TRUE	-3	Uint16
7-6* Feedback Conversion						
7-60	Feedback 1 Conversion	[0] Linear	All set-ups	TRUE	-	Uint8
7-62	Feedback 2 Conversion	[0] Linear	All set-ups	TRUE	-	Uint8

5.2.9 8-** Communications and Options

Parameter #	Parameter description	Default value	4 set-up	Change during operation	Conversion index	Type
8-0* General Settings						
8-01	Control Site	[0] Digital and ctrl.word	All set-ups	TRUE	-	Uint8
8-02	Control Source	Size Related	All set-ups	TRUE	-	Uint8
8-03	Control Timeout Time	1 s	1 set-up	TRUE	-1	Uint16
8-04	Control Timeout Function	[0] Off	1 set-up	TRUE	-	Uint8
8-07	Diagnosis Trigger	[0] Disable	1 set-up	TRUE	-	Uint8
8-1* Ctrl. Word Settings						
8-10	Control Word Profile	[0] FC profile	All set-ups	TRUE	-	Uint8
8-14	Configurable Control Word CTW	[1] Profile default	All set-ups	TRUE	-	Uint8
8-19	Product Code	Size Related	1 set-up	TRUE	0	Uint32
8-3* FC Port Settings						
8-30	Protocol	[0] FC	1 set-up	TRUE	-	Uint8
8-31	Address	1 N/A	1 set-up	TRUE	0	Uint8
8-32	Baud Rate	Size Related	1 set-up	TRUE	-	Uint8
8-33	Parity / Stop Bits	Size Related	1 set-up	TRUE	-	Uint8
8-35	Minimum Response Delay	0.01 s	1 set-up	TRUE	-3	Uint16
8-36	Maximum Response Delay	Size Related	1 set-up	TRUE	-3	Uint16
8-37	Maximum Inter-char delay	0.025 s	1 set-up	TRUE	-3	Uint16
8-4* FC MC protocol set						
8-42	PCD Write Configuration	Size Related	2 set-ups	TRUE	-	Uint8
8-43	PCD Read Configuration	Size Related	1 set-up	TRUE	-	uint8
8-5* Digital/Bus						
8-50	Coasting Select	[3] Logic OR	All set-ups	TRUE	-	Uint8
8-51	Quick Stop Select	[3] Logic OR	All set-ups	TRUE	-	Uint8
8-52	DC Brake Select	[3] Logic OR	All set-ups	TRUE	-	Uint8
8-53	Start Select	[3] Logic OR	All set-ups	TRUE	-	Uint8
8-54	Reversing Select	[3] Logic OR	All set-ups	TRUE	-	Uint8
8-55	Set-up Select	[3] Logic OR	All set-ups	TRUE	-	Uint8
8-56	Preset Reference Select	[3] Logic OR	All set-ups	TRUE	-	Uint8

Parameter #	Parameter description	Default value	4 set-up	Change during operation	Conversion index	Type
8-57	Profdrive OFF2 Select	[3] Logic OR	All set-ups	TRUE	-	Uint8
8-58	Profdrive OFF3 Select	[3] Logic OR	All set-ups	TRUE	-	Uint8
8-7* BACnet						
8-79	Protocol Firmware version	Size Related	1 set-up	FALSE	-2	Uint16
8-8* FC Port Diagnostics						
8-80	Bus Message Count	0 N/A	1 set-up	TRUE	0	Uint32
8-81	Bus Error Count	0 N/A	1 set-up	TRUE	0	Uint32
8-82	Slave Messages Rcvd	0 N/A	1 set-up	TRUE	0	Uint32
8-83	Slave Error Count	0 N/A	1 set-up	TRUE	0	Uint32
8-84	Slave Messages Sent	0 N/A	1 set-up	TRUE	0	Uint32
8-85	Slave Timeout Errors	0 N/A	1 set-up	TRUE	0	Uint32
8-88	Reset FC port Diagnostics	[0] Do not reset	1 set-up	TRUE	-	Uint8
8-9* Bus Feedback						
8-90	Bus Jog 1 Speed	100 RPM	All set-ups	TRUE	67	Uint16
8-91	Bus Jog 2 Speed	200 RPM	All set-ups	TRUE	67	Uint16

5.2.10 9-** PROFdrive

Parameter #	Parameter description	Default value	4 set-up	Change during operation	Conversion index	Type
9-00	Setpoint	0 N/A	All set-ups	TRUE	0	Uint16
9-07	Actual Value	0 N/A	All set-ups	FALSE	0	Uint16
9-15	PCD Write Configuration	Size Related	1 set-up	TRUE	-	Uint16
9-16	PCD Read Configuration	Size Related	1 set-up	TRUE	-	Uint16
9-18	Node Address	126 N/A	1 set-up	TRUE	0	Uint8
9-19	Drive Unit System Number	1037 N/A	All set-ups	TRUE	0	Uint16
9-22	Telegram Selection	[100] None	1 set-up	TRUE	-	Uint8
9-23	Parameters for Signals	0	All set-ups	TRUE	-	Uint16
9-27	Parameter Edit	[1] Enabled	1 set-up	FALSE	-	Uint16
9-28	Process Control	[1] Enable cyclic master	1 set-up	FALSE	-	Uint8
9-44	Fault Message Counter	0 N/A	All set-ups	TRUE	0	Uint16
9-45	Fault Code	0 N/A	All set-ups	TRUE	0	Uint16
9-47	Fault Number	0 N/A	All set-ups	TRUE	0	Uint16
9-52	Fault Situation Counter	0 N/A	All set-ups	TRUE	0	Uint16
9-53	Profibus Warning Word	0 N/A	All set-ups	TRUE	0	V2
9-63	Actual Baud Rate	[255] No baudrate found	All set-ups	TRUE	-	Uint8
9-64	Device Identification	0 N/A	All set-ups	TRUE	0	Uint16
9-65	Profile Number	0 N/A	All set-ups	TRUE	0	OctStr[2]
9-67	Control Word 1	0 N/A	All set-ups	TRUE	0	V2
9-68	Status Word 1	0 N/A	All set-ups	TRUE	0	V2
9-70	Edit Set-up	[9] Active Set-up	1 set-up	TRUE	-	Uint8
9-71	Profibus Save Data Values	[0] Off	All set-ups	TRUE	-	Uint8
9-72	ProfibusDriveReset	[0] No action	1 set-up	FALSE	-	Uint8
9-75	DO Identification	0 N/A	All set-ups	TRUE	0	Uint16
9-80	Defined Parameters (1)	0 N/A	All set-ups	FALSE	0	Uint16
9-81	Defined Parameters (2)	0 N/A	All set-ups	FALSE	0	Uint16
9-82	Defined Parameters (3)	0 N/A	All set-ups	FALSE	0	Uint16
9-83	Defined Parameters (4)	0 N/A	All set-ups	FALSE	0	Uint16
9-84	Defined Parameters (5)	0 N/A	All set-ups	FALSE	0	Uint16
9-85	Defined Parameters (6)	0 N/A	All set-ups	FALSE	0	Uint16

Parameter #	Parameter description	Default value	4 set-up	Change during operation	Conversion index	Type
9-90	Changed Parameters (1)	0 N/A	All set-ups	FALSE	0	Uint16
9-91	Changed Parameters (2)	0 N/A	All set-ups	FALSE	0	Uint16
9-92	Changed Parameters (3)	0 N/A	All set-ups	FALSE	0	Uint16
9-93	Changed Parameters (4)	0 N/A	All set-ups	FALSE	0	Uint16
9-94	Changed Parameters (5)	0 N/A	All set-ups	FALSE	0	Uint16
9-99	Profibus Revision Counter	0 N/A	All set-ups	TRUE	0	Uint16

5.2.11 10-** CAN Fieldbus

5

Parameter #	Parameter description	Default value	4 set-up	Change during operation	Conversion index	Type
10-0* Common Settings						
10-01	Baud Rate Select	[20] 125 Kbps	1 set-up	TRUE	-	Uint8
10-02	Node ID	127 N/A	1 set-up	TRUE	0	Uint8
10-05	Readout Transmit Error Counter	0 N/A	All set-ups	TRUE	0	Uint8
10-06	Readout Receive Error Counter	0 N/A	All set-ups	TRUE	0	Uint8
10-3* Parameter Access						
10-31	Store Data Values	[0] Off	All set-ups	TRUE	-	uint8
10-33	Store Always	[0] Off	1 set-up	TRUE	-	Uint8

5.2.12 12-** Ethernet

Parameter #	Parameter description	Default value	4 set-up	Change during operation	Conversion index	Type
12-0* IP Settings						
12-00	IP Address Assignment	[10] DCP	1 set-up	TRUE	-	Uint8
12-01	IP Address	0 N/A	1 set-up	TRUE	0	OctStr[4]
12-02	Subnet Mask	0 N/A	1 set-up	TRUE	0	OctStr[4]
12-03	Default Gateway	0 N/A	1 set-up	TRUE	0	OctStr[4]
12-04	DHCP Server	0 N/A	1 set-up	TRUE	0	OctStr[4]
12-05	Lease Expires	0 N/A	All set-ups	TRUE	0	TimD
12-06	Name Servers	0 N/A	1 set-up	TRUE	0	OctStr[4]
12-07	Domain Name	0 N/A	1 set-up	TRUE	0	VisStr[48]
12-08	Host Name	0 N/A	1 set-up	TRUE	0	VisStr[48]
12-09	Physical Address	0 N/A	1 set-up	TRUE	0	VisStr[17]
12-1* Ethernet Link Parameters						
12-10	Link Status	[0] No Link	All set-ups	TRUE	-	Uint8
12-11	Link Duration	Size Related	All set-ups	TRUE	0	TimD
12-12	Auto Negotiation	[1] On	1 set-up	TRUE	-	Uint8
12-13	Link Speed	[0] None	1 set-up	TRUE	-	Uint8
12-14	Link Duplex	[1] Full Duplex	1 set-up	TRUE	-	Uint8
12-8* Other Ethernet Services						
12-80	FTP Server	[0] Disabled	1 set-up	TRUE	-	Uint8
12-81	HTTP Server	[0] Disabled	1 set-up	TRUE	-	Uint8
12-82	SMTP Service	[0] Disabled	1 set-up	TRUE	-	Uint8
12-89	Transparent Socket Channel Port	4000 N/A	1 set-up	TRUE	0	Uint16
12-9* Advanced Ethernet Services						
12-90	Cable Diagnostic	[0] Disabled	1 set-up	TRUE	-	Uint8
12-91	Auto Cross Over	[1] Enabled	1 set-up	TRUE	-	Uint8
12-92	IGMP Snooping	[1] Enabled	1 set-up	TRUE	-	Uint8
12-93	Cable Error Length	0 N/A	1 set-up	TRUE	0	Uint16

Parameter #	Parameter description	Default value	4 set-up	Change during operation	Conversion index	Type
12-94	Broadcast Storm Protection	-1 %	1 set-up	TRUE	0	Int8
12-95	Broadcast Storm Filter	[0] Broadcast only	1 set-up	TRUE	-	UInt8
12-96	Port Config	Size Related	1 set-up	TRUE	-	UInt8
12-98	Interface Counters	4000 N/A	All set-ups	TRUE	0	UInt32
12-99	Media Counters	0 N/A	All set-ups	TRUE	0	UInt32

5.2.13 13-** Smart Logic Control

Parameter #	Parameter description	Default value	4 set-up	Change during operation	Conversion index	Type
13-0* SLC Settings						
13-00	SL Controller Mode	[0] Off	1 set-up	TRUE	-	UInt8
13-01	Start Event	[39] Start command	1 set-up	TRUE	-	UInt8
13-02	Stop Event	[40] Drive stopped	1 set-up	TRUE	-	UInt8
13-03	Reset SLC	[0] Do not reset SLC	1 set-up	TRUE	-	UInt8
13-1* Comparators						
13-10	Comparator Operand	[0] Disabled	1 set-up	TRUE	-	UInt8
13-11	Comparator Operator	[1] Approx.Equal (~)	1 set-up	TRUE	-	UInt8
13-12	Comparator Value	0 N/A	1 set-up	TRUE	-3	Int32
13-2* Timers						
13-20	SL Controller Timer	0 s	1 set-up	TRUE	-2	UInt32
13-4* Logic Rules						
13-40	Logic Rule Boolean 1	[0] False	1 set-up	TRUE	-	UInt8
13-41	Logic Rule Operator 1	[0] Disabled	1 set-up	TRUE	-	UInt8
13-42	Logic Rule Boolean 2	[0] False	1 set-up	TRUE	-	UInt8
13-43	Logic Rule Operator 2	[0] Disabled	1 set-up	TRUE	-	UInt8
13-44	Logic Rule Boolean 3	[0] False	1 set-up	TRUE	-	UInt8
13-5* States						
13-51	SL Controller Event	[0] False	1 set-up	TRUE	-	UInt8
13-52	SL Controller Action	[0] Disabled	1 set-up	TRUE	-	UInt8

5.2.14 14-** Special Functions

Parameter #	Parameter description	Default value	4 set-up	Change during operation	Conversion index	Type
14-0* Inverter Switching						
14-01	Switching Frequency	Size Related	All set-ups	TRUE	-	UInt8
14-03	Overmodulation	[1] On	All set-ups	FALSE	-	UInt8
14-07	Dead Time Compensation Level	Size Related	All set-ups	FALSE	0	UInt8
14-08	Damping Gain Factor	Size Related	All set-ups	TRUE	0	UInt8
14-09	Dead Time Bias Current Level	Size Related	All set-ups	FALSE	0	UInt8
14-1* Mains On/Off						
14-10	Mains Failure	[0] No function	All set-ups	FALSE	-	UInt8
14-11	Mains Voltage at Mains Fault	Size Related	All set-ups	TRUE	0	UInt16
14-12	Function at Mains Imbalance	[0] Trip	1 set-up	TRUE	-	UInt8
14-15	Kin. Backup Trip Recovery Level	Size Related	All set-ups	TRUE	-3	UInt32
14-2* Reset Functions						
14-20	Reset Mode	[0] Manual reset	All set-ups	TRUE	-	UInt8
14-21	Automatic Restart Time	10 s	All set-ups	TRUE	0	UInt16

Parameter #	Parameter description	Default value	4 set-up	Change during operation	Conversion index	Type
14-22	Operation Mode	[0] Normal operation	1 set-up	TRUE	-	Uint8
14-24	Trip Delay at Current Limit	60 s	All set-ups	TRUE	0	Uint8
14-25	Trip Delay at Torque Limit	60 s	All set-ups	TRUE	0	Uint8
14-27	Action At Inverter Fault	[1] Warning	All set-ups	TRUE	-	Uint8
14-28	Production Settings	[0] No action	1 set-up	FALSE	-	Uint8
14-29	Service Code	0 N/A	1 set-up	TRUE	0	Uint32
14-3* Current Limit Ctrl.						
14-30	Current Lim Ctrl, Proportional Gain	100 %	All set-ups	TRUE	0	Uint16
14-31	Current Lim Ctrl, Integration Time	0.020 s	All set-ups	TRUE	-3	Uint16
14-32	Current Lim Ctrl, Filter Time	5 ms	All set-ups	TRUE	-4	Uint16
14-4* Energy Optimising						
14-40	VT Level	66 %	All set-ups	FALSE	0	Uint8
14-41	AEO Minimum Magnetisation	66 %	All set-ups	FALSE	0	Uint8
14-44	d-axis current optimization for IPM	100 %	All set-ups	TRUE	0	Uint8
14-5* Environment						
14-50	RFI Filter	[2] Grid Type	1 set-up	FALSE	-	Uint8
14-51	DC-Link Voltage Compensation	[1] On	All set-ups	FALSE	-	Uint8
14-52	Fan Control	[5] Constant-on mode	1 set-up	TRUE	-	Uint8
14-55	Output Filter	[0] No Filter	1 set-up	FALSE	-	Uint8
14-6* Auto Derate						
14-61	Function at Inverter Overload	[0] Trip	All set-ups	TRUE	-	Uint8
14-63	Min Switch Frequency	[2] 2.0 kHz	1 set-up	FALSE	-	Uint8
14-64	Dead Time Compensation Zero Current Level	[0] Disabled	All set-ups	FALSE	-	Uint8
14-65	Speed Derate Dead Time Compensation	Size Related	All set-ups	FALSE	0	Uint16
14-8* Options						
14-89	Option Detection	[0] Protect Option Config.	1 set-up	TRUE	-	Uint8
14-9* Fault Settings						
14-90	Fault Level	[3] Trip Lock	All set-ups	TRUE	-	Uint8

5.2.15 15-** Drive Information

Parameter #	Parameter description	Default value	4 set-up	Change during operation	Conversion index	Type
15-0* Operating Data						
15-00	Operating hours	0 h	1 set-up	TRUE	74	Uint32
15-01	Running Hours	0 h	1 set-up	TRUE	74	Uint32
15-02	kWh Counter	0 kWh	1 set-up	TRUE	75	Uint32
15-03	Power Up's	0 N/A	1 set-up	TRUE	0	Uint32
15-04	Over Temp's	0 N/A	1 set-up	TRUE	0	Uint16
15-05	Over Volt's	0 N/A	1 set-up	TRUE	0	Uint16
15-06	Reset kWh Counter	[0] Do not reset	1 set-up	TRUE	-	Uint8
15-07	Reset Running Hours Counter	[0] Do not reset	1 set-up	TRUE	-	Uint8
15-3* Alarm Log						
15-30	Alarm Log: Error Code	0 N/A	1 set-up	TRUE	0	Uint8
15-31	InternalFaultReason	0 N/A	1 set-up	TRUE	0	Int16

Parameter #	Parameter description	Default value	4 set-up	Change during operation	Conversion index	Type
15-4* Drive Identification						
15-40	FC Type	0 N/A	1 set-up	FALSE	0	VisStr[7]
15-41	Power Section	0 N/A	1 set-up	FALSE	0	VisStr[20]
15-42	Voltage	0 N/A	1 set-up	FALSE	0	VisStr[20]
15-43	Software Version	0 N/A	1 set-up	FALSE	0	VisStr[20]
15-44	Ordered TypeCode	0 N/A	1 set-up	FALSE	0	VisStr[41]
15-45	Actual Typecode String	0 N/A	All set-ups	FALSE	0	VisStr[40]
15-46	Drive Ordering No	0 N/A	1 set-up	FALSE	0	VisStr[9]
15-48	LCP Id No	0 N/A	1 set-up	FALSE	0	VisStr[21]
15-49	SW ID Control Card	0 N/A	1 set-up	FALSE	0	VisStr[21]
15-50	SW ID Power Card	0 N/A	1 set-up	FALSE	0	VisStr[21]
15-51	Drive Serial Number	0 N/A	1 set-up	FALSE	0	VisStr[13]
15-52	OEM Information	0 N/A	1 set-up	FALSE	0	VisStr[40]
15-53	Power Card Serial Number	0 N/A	1 set-up	FALSE	0	VisStr[21]
15-57	File Version	0 N/A	1 set-up	FALSE	0	Uint8
15-59	Filename	0 N/A	1 set-up	FALSE	0	VisStr[16]
15-6* Option Ident						
15-60	Option Mounted	Size Related	All set-ups	FALSE	0	VisStr[30]
15-61	Option SW Version	Size Related	All set-ups	FALSE	0	VisStr[20]
15-70	Option in Slot A	0 N/A	All set-ups	FALSE	0	VisStr[30]
15-71	Slot A Option SW Version	0 N/A	All set-ups	FALSE	0	VisStr[20]
15-9* Parameter Info						
15-92	Defined Parameters	0 N/A	1 set-up	TRUE	0	Uint16
15-97	Application Type	0 N/A	1 set-up	TRUE	0	Uint32
15-98	Drive Identification	0 N/A	1 set-up	FALSE	0	VisStr[56]
15-99	Parameter Metadata	0 N/A	1 set-up	FALSE	0	Uint16

5.2.16 16-** Data Readouts

Parameter #	Parameter description	Default value	4 set-up	Change during operation	Conversion index	Type
16-0* General Status						
16-00	Control Word	0 N/A	1 set-up	TRUE	0	Uint16
16-01	Reference [Unit]	0 ReferenceFeed-backUnit	1 set-up	TRUE	-3	Int32
16-02	Reference [%]	0 %	1 set-up	TRUE	-1	Int16
16-03	Status Word	0 N/A	1 set-up	TRUE	0	Uint16
16-05	Main Actual Value [%]	0 %	1 set-up	TRUE	-2	Int16
16-09	Custom Readout	0 CustomReadoutUnit	1 set-up	TRUE	-2	Int32
16-1* Motor Status						
16-10	Power [kW]	0 kW	1 set-up	TRUE	-3	Uint32
16-11	Power [hp]	0 hp	1 set-up	TRUE	-3	Uint32
16-12	Motor Voltage	0 V	1 set-up	TRUE	-1	Uint32
16-13	Frequency	0 Hz	1 set-up	TRUE	-1	Uint32
16-14	Motor current	0 A	1 set-up	TRUE	-2	Uint16
16-15	Frequency [%]	0 %	1 set-up	TRUE	-1	Uint16
16-16	Torque [Nm]	0 Nm	All set-ups	FALSE	-1	Int32
16-17	Speed [RPM]	0 RPM	All set-ups	FALSE	0	Int32
16-18	Motor Thermal	0 %	1 set-up	TRUE	0	Uint8
16-20	Motor Angle	0 N/A	All set-ups	TRUE	0	Uint16
16-22	Torque [%]	0 %	All set-ups	FALSE	0	Int16

Parameter #	Parameter description	Default value	4 set-up	Change during operation	Conversion index	Type
16-3* Drive Status						
16-30	DC Link Voltage	0 V	1 set-up	TRUE	0	Uint32
16-33	Brake Energy /2 min	0 kW	All set-ups	FALSE	0	Uint32
16-34	Heatsink Temp.	0 °C	1 set-up	TRUE	100	Int8
16-35	Inverter Thermal	0 %	1 set-up	TRUE	0	Uint8
16-36	Inv. Nom. Current	0 A	1 set-up	TRUE	-2	Uint16
16-37	Inv. Max. Current	0 A	1 set-up	TRUE	-2	Uint16
16-38	SL Controller State	0 N/A	1 set-up	TRUE	0	Uint8
16-39	Control Card Temp.	0 °C	All set-ups	FALSE	100	Uint16
16-5* Ref. & Feedb.						
16-50	External Reference	0 %	1 set-up	TRUE	-1	Int16
16-52	Feedback[Unit]	0 ProcessCtrlUnit	1 set-up	TRUE	-3	Int32
16-53	Digi Pot Reference	0 N/A	All set-ups	FALSE	-2	Int16
16-57	Feedback [RPM]	0 RPM	All set-ups	FALSE	67	Int32
16-6* Inputs & Outputs						
16-60	Digital Input	0 N/A	1 set-up	TRUE	0	Uint16
16-61	Terminal 53 Setting	Size Related	1 set-up	TRUE	-	Uint8
16-62	Analog Input 53	1 N/A	1 set-up	TRUE	-2	Uint16
16-63	Terminal 54 Setting	Size Related	1 set-up	TRUE	-	Uint8
16-64	Analog Input AI54	1 N/A	1 set-up	TRUE	-2	Uint16
16-65	Analog Output 42 [mA]	0 mA	1 set-up	TRUE	-2	Uint16
16-66	Digital Output	0 N/A	1 set-up	TRUE	0	VisStr[5]
16-67	Pulse Input 29[Hz]	0 N/A	All set-ups	FALSE	0	Int32
16-68	Pulse Input 33 [Hz]	0 N/A	All set-ups	FALSE	0	Int32
16-69	Pulse Output 27 [Hz]	0 N/A	All set-ups	FALSE	0	Int32
16-71	Relay Output	0 N/A	1 set-up	TRUE	0	Uint16
16-72	Counter A	0 N/A	1 set-up	TRUE	0	Int16
16-73	Counter B	0 N/A	1 set-up	TRUE	0	Int16
16-74	Prec. Stop Counter	0 N/A	All set-ups	TRUE	0	Uint32
16-8* Fieldbus & FC Port						
16-80	Fieldbus CTW 1	0 N/A	1 set-up	TRUE	0	Uint16
16-82	Fieldbus REF 1	0 N/A	1 set-up	TRUE	0	Int16
16-84	Comm. Option STW	0 N/A	1 set-up	TRUE	0	Uint16
16-85	FC Port CTW 1	1084 N/A	1 set-up	FALSE	0	uint16
16-86	FC Port REF 1	0 N/A	1 set-up	TRUE	0	Int16
16-9* Diagnosis Readouts						
16-90	Alarm Word	0 N/A	1 set-up	TRUE	0	Uint32
16-91	Alarm Word 2	0 N/A	1 set-up	TRUE	0	Uint32
16-92	Warning Word	0 N/A	1 set-up	TRUE	0	Uint32
16-93	Warning Word 2	0 N/A	1 set-up	TRUE	0	Uint32
16-94	Ext. Status Word	0 N/A	1 set-up	TRUE	0	Uint32
16-95	Ext. Status Word 2	0 N/A	1 set-up	TRUE	0	Uint32
16-97	Alarm Word 3	0 N/A	1 set-up	TRUE	0	Uint32

5.2.17 18-** Data Readouts 2

Parameter #	Parameter description	Default value	4 set-up	Change during operation	Conversion index	Type
18-9* PID Readouts						
18-90	Process PID Error	0 %	All set-ups	FALSE	-1	Int16
18-91	Process PID Output	0 %	All set-ups	FALSE	-1	Int16
18-92	Process PID Clamped Output	0 %	All set-ups	FALSE	-1	Int16
18-93	Process PID Gain Scaled Output	0 %	All set-ups	FALSE	-1	Int16

5.2.18 21-** Ext. Closed Loop

Parameter #	Parameter description	Default value	4 set-up	Change during operation	Conversion index	Type
21-0* Ext. CL Autotuning						
21-09	Extended PID Enable	[0] Disabled	All set-ups	TRUE	-	UInt8
21-1* Ext. CL 1 Ref./Fb.						
21-11	Ext. 1 Minimum Reference	0 ExtPID1Unit	All set-ups	TRUE	-3	Int32
21-12	Ext. 1 Maximum Reference	100 ExtPID1Unit	All set-ups	TRUE	-3	Int32
21-13	Ext. 1 Reference Source	[0] No function	All set-ups	TRUE	-	UInt8
21-14	Ext. 1 Feedback Source	[0] No function	All set-ups	TRUE	-	UInt8
21-15	Ext. 1 Setpoint	0 ExtPID1Unit	All set-ups	TRUE	-3	Int32
21-17	Ext. 1 Reference [Unit]	0 ExtPID1Unit	All set-ups	TRUE	-3	Int32
21-18	Ext. 1 Feedback [Unit]	0 ExtPID1Unit	All set-ups	TRUE	-3	Int32
21-19	Ext. 1 Output [%]	0 %	All set-ups	TRUE	0	Int32
Ext. CL 1 PID						
21-20	Ext. 1 Normal/Inverse Control	[0] Normal	All set-ups	TRUE	-	UInt8
21-21	Ext. 1 Proportional Gain	0.01 N/A	All set-ups	TRUE	-2	UInt16
21-22	Ext. 1 Integral Time	10000 s	All set-ups	TRUE	-2	UInt32
21-23	Ext. 1 Differentiation Time	0 s	All set-ups	TRUE	-2	UInt16
21-24	Ext. 1 Dif. Gain Limit	5 N/A	All set-ups	TRUE	-1	UInt16

5.2.19 22-** Application Functions

Parameter #	Parameter description	Default value	4 set-up	Change during operation	Conversion index	Type
22-4* Sleep Mode						
22-40	Minimum Run Time	10 s	All set-ups	TRUE	0	UInt16
22-41	Minimum Sleep Time	10 s	All set-ups	TRUE	0	UInt16
22-43	Wake-Up Speed [Hz]	10 N/A	All set-ups	TRUE	-1	UInt16
22-44	Wake-Up Ref./FB Diff	10 %	All set-ups	TRUE	0	UInt8
22-45	Setpoint Boost	0 %	All set-ups	TRUE	0	Int8
22-46	Maximum Boost Time	60 s	All set-ups	TRUE	0	UInt16
22-47	Sleep Speed [Hz]	0 N/A	All set-ups	TRUE	-1	UInt16
22-6* Broken Belt Detection						
22-60	Broken Belt Function	[0] Off	All set-ups	TRUE	-	UInt8
22-61	Broken Belt Torque	10 %	All set-ups	TRUE	0	UInt8
22-62	Broken Belt Delay	10 s	All set-ups	TRUE	0	UInt16

5.2.20 30-** Special Features

Parameter #	Parameter description	Default value	4 set-up	Change during operation	Conversion index	Type
30-2* Adv. Start Adjust						
30-20	High Starting Torque Time [s]	Size Related	All set-ups	TRUE	-2	Uint16
30-21	High Starting Torque Current [%]	Size Related	All set-ups	TRUE	-1	Uint32
30-22	Locked Rotor Detection	[0] Off	All set-ups	TRUE	-	Uint8
30-23	Locked Rotor Detection Time [s]	0.10 s	All set-ups	TRUE	-2	Uint8

5.2.21 32-** Motion Control Basic Settings

Parameter #	Parameter description	Default value	4 set-up	Change during operation	Conversion index	Type
32-11	User Unit Denominator	1 N/A	1 set-up	FALSE	0	Uint32
32-12	User Unit Numerator	1 N/A	1 set-up	FALSE	0	Uint32
32-67	Max. Tolerated Position Error	2000000 N/A	1 set-up	TRUE	0	Uint32
32-80	Maximum Allowed Velocity	1500 RPM	1 set-up	FALSE	67	Uint16
32-81	Motion Ctrl Quick Stop Ramp	1000 ms	1 set-up	TRUE	-3	Uint32

5.2.22 33-** Motion Control Adv. Settings

Parameter #	Parameter description	Default value	4 set-up	Change during operation	Conversion index	Type
33-00	Homing Mode	[0] Not forced	1 set-up	TRUE	-	Uint8
33-01	Home Offset	0 N/A	1 set-up	TRUE	0	Int32
33-02	Home Ramp Time	10 ms	1 set-up	TRUE	-3	Uint16
33-03	Homing Velocity	100 RPM	1 set-up	TRUE	67	Int16
33-04	Homing Behaviour	[1] Reverse no index	1 set-up	TRUE	-	Uint8
33-41	Negative Software Limit	-500000 N/A	1 set-up	TRUE	0	Int32
33-42	Positive Software Limit	500000 N/A	1 set-up	TRUE	0	Int32
33-43	Negative Software Limit Active	[0] Inactive	1 set-up	TRUE	-	Uint8
33-44	Positive Software Limit Active	[0] Inactive	1 set-up	TRUE	-	Uint8
33-47	Target Position Window	0 N/A	1 set-up	TRUE	0	Uint16

5.2.23 34-** Motion Control Data Readouts

Parameter #	Parameter description	Default value	4 set-up	Change during operation	Conversion index	Type
34-0* PCD Write Par.						
34-01	PCD 1 Write For Application	0 N/A	All set-ups	TRUE	0	Uint16
34-02	PCD 2 Write For Application	0 N/A	All set-ups	TRUE	0	Uint16
34-03	PCD 3 Write For Application	0 N/A	All set-ups	TRUE	0	Uint16
34-04	PCD 4 Write For Application	0 N/A	All set-ups	TRUE	0	Uint16
34-05	PCD 5 Write For Application	0 N/A	All set-ups	TRUE	0	Uint16
34-06	PCD 6 Write For Application	0 N/A	All set-ups	TRUE	0	Uint16
34-07	PCD 7 Write For Application	0 N/A	All set-ups	TRUE	0	Uint16
34-08	PCD 8 Write For Application	0 N/A	All set-ups	TRUE	0	Uint16
34-09	PCD 9 Write For Application	0 N/A	All set-ups	TRUE	0	Uint16
34-10	PCD 10 Write For Application	0 N/A	All set-ups	TRUE	0	Uint16
34-2* PCD Read Par.						
34-21	PCD 1 Read For Application	0 N/A	All set-ups	TRUE	0	Uint16

Parameter #	Parameter description	Default value	4 set-up	Change during operation	Conversion index	Type
34-22	PCD 2 Read For Application	0 N/A	All set-ups	TRUE	0	Uint16
34-23	PCD 3 Read For Application	0 N/A	All set-ups	TRUE	0	Uint16
34-24	PCD 4 Read For Application	0 N/A	All set-ups	TRUE	0	Uint16
34-25	PCD 5 Read For Application	0 N/A	All set-ups	TRUE	0	Uint16
34-26	PCD 6 Read For Application	0 N/A	All set-ups	TRUE	0	Uint16
34-27	PCD 7 Read For Application	0 N/A	All set-ups	TRUE	0	Uint16
34-28	PCD 8 Read For Application	0 N/A	All set-ups	TRUE	0	Uint16
34-29	PCD 9 Read For Application	0 N/A	All set-ups	TRUE	0	Uint16
34-30	PCD 10 Read For Application	0 N/A	All set-ups	TRUE	0	Uint16
34-5* Process Data						
34-50	Actual Position	0 N/A	All set-ups	TRUE	0	Int32
34-56	Track Error	0 N/A	All set-ups	TRUE	0	Int32

5.2.24 37-** Application Settings

Parameter #	Parameter description	Default value	4 set-up	Change during operation	Conversion index	Type
37-0* ApplicationMode						
37-00	Application Mode	[0] Drive mode	1 set-up	FALSE	-	Uint8
37-1* Position Control						
37-01	Pos. Feedback Source	[0] 24V Encoder	1 set-up	FALSE	-	uint8
37-02	Pos. Target	0 N/A	1 set-up	FALSE	0	Int32
37-03	Pos. Type	[0] Absolute	1 set-up	FALSE	-	uint8
37-04	Pos. Velocity	100 RPM	1 set-up	FALSE	67	uint16
37-05	Pos. Ramp Up Time	5000 ms	1 set-up	FALSE	-3	uint32
37-06	Pos. Ramp Down Time	5000 ms	1 set-up	FALSE	-3	uint32
37-07	Pos. Auto Brake Ctrl	[1] Enable	1 set-up	TRUE	-	uint8
37-08	Pos. Hold Delay	0 ms	1 set-up	TRUE	-3	uint32
37-09	Pos. Coast Delay	200 ms	1 set-up	TRUE	-3	uint16
37-10	Pos. Brake Delay	200 ms	1 set-up	TRUE	-3	uint16
37-11	Pos. Brake Wear Limit	0 N/A	1 set-up	TRUE	0	uint32
37-12	Pos. PID Anti Windup	[1] Enable	1 set-up	TRUE	-	uint8
37-13	Pos. PID Output Clamp	1000 N/A	1 set-up	TRUE	0	uint16
37-14	Pos. Ctrl. Source	[0] DI	1 set-up	TRUE	-	uint8
37-15	Pos. Direction Block	[0] No Blocking	1 set-up	TRUE	-	uint8
37-17	Pos. Ctrl Fault Behaviour	[0] Ramp Down&Brake	1 set-up	FALSE	-	uint8
37-18	Pos. Ctrl Fault Reason	[0] No Fault	1 set-up	TRUE	-	uint8
37-19	Pos. New Index	0 N/A	1 set-up	TRUE	0	uint8

6 Troubleshooting

6.1 Warnings and Alarms

When the frequency converter fault circuitry detects a fault condition or a pending fault, a warning or alarm is issued. A flashing display on the LCP indicates an alarm or warning condition and the associated number code on line 2. Sometimes a warning precedes an alarm.

6.1.1 Alarms

An alarm causes the frequency converter to trip (suspend operation). The frequency converter has 3 trip conditions which are shown in line 1:

Trip (auto restart)

The frequency converter is programmed to restart automatically after the fault is removed. The number of automatic reset attempts can be continuous or limited to a programmed number of attempts. If the selected number of automatic reset attempts is exceeded, the trip condition changes to trip (reset).

Trip (reset)

Requires resetting of the frequency converter before operation after a fault is cleared. To reset the frequency converter manually, press [Reset] or use a digital input, or a fieldbus command. For NLCP, stop and reset are the same key, [Off/Reset]. If [Off/Reset] is used to reset the frequency converter, press [Start] to initiate a run command in either hand-on mode or auto-on mode.

Trip lock (disc>mains)

Disconnect the mains AC input power to the frequency converter long enough for the display to go blank. Remove the fault condition and reapply power. Following power-up, the fault indication changes to trip (reset) and allows for manual, digital, or fieldbus reset.

6.1.2 Warnings

During a warning, the frequency converter remains operational, although the warning flashes for as long as the condition exists. The frequency converter could, however, reduce the warning condition. For example, if the warning shown was *warning 12, Torque Limit*, the frequency converter would reduce speed to compensate for the overcurrent condition. Sometimes, if the condition is not corrected or worsens, an alarm condition is activated and the frequency converter stops output to the motor terminals. Line 1 identifies the warning in plain language, and line 2 identifies the warning number.

6.1.3 Warning/Alarm Messages

The LEDs on the front of the frequency converter and a code in the display signal a warning or an alarm.

Warning	Yellow
Alarm	Flashing red

Table 6.1 LED Indication

A warning indicates a condition that requires attention, or a trend that would eventually require attention. A warning remains active until the cause is no longer present. Under some circumstances, motor operation could continue.

An alarm triggers a trip. The trip removes power to the motor. It can be reset after the condition has been cleared by pressing [Reset], or through a digital input (*parameter group 5-1* Digital Inputs*). The event that caused an alarm cannot damage the frequency converter, or cause a dangerous condition. Alarms must be reset to restart operation once their cause has been rectified.

The reset can be done in 3 ways:

- Press [Reset].
- A digital reset input.
- Serial communication/optional fieldbus reset signal.

NOTICE

After a manual reset pressing [Reset], press [Auto On] to restart the motor.

A warning precedes an alarm.

A trip lock is an action when an alarm occurs which can damage the frequency converter or connected equipment. Power is removed from the motor. A trip lock can only be reset after a cycling power has cleared the condition. Once the problem has been rectified, only the alarm continues flashing until the frequency converter is reset.

The alarm words, warning words and extended status words can be accessed via fieldbus or optional fieldbus for diagnosis.

6.1.4 Warning and Alarm Code List

An (X) marked in *Table 6.2* indicates that the warning or alarm has occurred.

No.	Description	Warning	Alarm	Trip lock	Cause
2	Live zero error	X	X	–	The signal on terminal 53 or 54 is less than 50% of value set in <i>parameter 6-10 Terminal 53 Low Voltage</i> , <i>parameter 6-20 Terminal 54 Low Voltage</i> , and <i>parameter 6-22 Terminal 54 Low Current</i> .
3	No motor	X	–	–	No motor has been connected to the output of the frequency converter.
4	Mains phase loss ¹⁾	X	X	X	Missing phase on the supply side, or the voltage imbalance is too high. Check the supply voltage.
7	DC overvoltage ¹⁾	X	X	–	DC-link voltage exceeds limit.
8	DC undervoltage ¹⁾	X	X	–	DC-link voltage drops below the voltage warning low limit.
9	Inverter overloaded	X	X	–	More than 100% load for too long.
10	Motor ETR overtemperature	X	X	–	Motor is too hot due to more than 100% load for too long.
11	Motor thermistor overtemperature	X	X	–	Thermistor or thermistor connection is disconnected, or the motor is too hot.
12	Torque limit	X	X	–	Torque exceeds value set in either <i>parameter 4-16 Torque Limit Motor Mode</i> or <i>parameter 4-17 Torque Limit Generator Mode</i> .
13	Overcurrent	X	X	X	Inverter peak current limit is exceeded. If this alarm occurs on power-up, check whether power cables are mistakenly connected to the motor terminals.
14	Ground fault	–	X	X	Discharge from output phases to ground.
16	Short circuit	–	X	X	Short circuit in motor or on motor terminals.
17	Control word timeout	X	X	–	No communication to frequency converter.
25	Brake resistor short-circuited	–	X	X	Brake resistor is short-circuited, thus the brake function is disconnected.
26	Brake overload	X	X	–	The power transmitted to the brake resistor over the last 120 s exceeds the limit. Possible corrections: Decrease brake energy via lower speed or longer ramp time.
27	Brake IGBT/brake chopper short-circuited	–	X	X	Brake transistor is short-circuited, thus the brake function is disconnected.
28	Brake check	–	X	–	Brake resistor is not connected/working.
30	U phase loss	–	X	X	Motor phase U is missing. Check the phase.
31	V phase loss	–	X	X	Motor phase V is missing. Check the phase.
32	W phase loss	–	X	X	Motor phase W is missing. Check the phase.
34	Fieldbus fault	X	X	–	PROFIBUS communication issues have occurred.
35	Option fault	–	X	–	Fieldbus detects internal faults.
36	Mains failure	X	X	–	This warning/alarm is only active if the supply voltage to the frequency converter is less than the value set in <i>parameter 14-11 Mains Fault Voltage Level</i> , and <i>parameter 14-10 Mains Failure</i> is NOT set to [0] No Function.
38	Internal fault	–	X	X	Contact the local Danfoss supplier.
40	Overload T27	X	–	–	Check the load connected to terminal 27 or remove short-circuit connection.
46	Gate drive voltage fault	–	X	X	–
47	24 V supply low	X	X	X	24 V DC may be overloaded.
49	Speed limit	–	X	–	The motor speed is below the specified limit in <i>parameter 1-87 Trip Speed Low [Hz]</i> .

No.	Description	Warning	Alarm	Trip lock	Cause
50	AMA calibration failed	–	X	–	A calibration error has occurred.
51	AMA check U_{nom} and I_{nom}	–	X	–	Wrong setting for motor voltage and/or motor current.
52	AMA low I_{nom}	–	X	–	Motor current is too low. Check the settings.
53	AMA big motor	–	X	–	The power size of the motor is too large for the AMA to operate.
54	AMA small motor	–	X	–	The power size of the motor is too small for the AMA to operate.
55	AMA parameter range	–	X	–	The parameter values of the motor are outside of the acceptable range. AMA does not run.
56	AMA interrupt	–	X	–	The AMA is interrupted.
57	AMA timeout	–	X	–	–
58	AMA internal	–	X	–	Contact Danfoss.
59	Current limit	X	X	–	Frequency converter overload.
60	External interlock	–	X	–	External interlock has been activated.
61	Encoder loss	X	X	–	–
63	Mechanical brake low	–	X	–	The actual motor current has not exceeded the release brake current within the start delay time window.
65	Control card temp	X	X	X	The cutout temperature of the control card has exceeded the upper limit.
67	Option change	–	X	–	A new option is detected or a mounted option is removed.
68	Safe Torque Off ²⁾	X	X	–	STO is activated. If STO is in manual restart mode (default), to resume normal operation, apply 24 V DC to terminals 37 and 38, and initiate a reset signal (via fieldbus, digital I/O, or [Reset]/[Off Reset] key). If STO is in automatic restart mode, applying 24 V DC to terminals 37 and 38 automatically resumes the frequency converter to normal operation.
69	Power card temp	X	X	X	The cutout temperature of the power card has exceeded the upper limit.
80	Drive initialized to default value	–	X	–	All parameter settings are initialized to default settings.
87	Auto DC braking	X	–	–	Occurs in IT mains when the frequency converter coasts, and the DC voltage is higher than 830 V for 400 V units and 425 V for 200 V units. The motor consumes energy on the DC link. This function can be enabled/disabled in <i>parameter 0-07 Auto DC Braking</i> .
88	Option detection	–	X	X	The option is removed successfully.
95	Broken belt	X	X	–	–
99	Locked rotor	–	X	–	Rotor is blocked.
120	Position control fault	–	X	–	–
126	Motor rotating	–	X	–	PM motor is rotating when execute AMA.
127	Back EMF too high	X	–	–	The back EMF of PM motor is too high before starting.
188	STO internal fault ²⁾	–	X	–	24 V DC supply is connected to only 1 of the 2 STO terminals (37 and 38), or a failure in STO channels is detected. Ensure that both terminals are powered by 24 V DC supply, and that the discrepancy between the signals at the 2 terminals is less than 12 ms. If the fault still occurs, contact the local Danfoss supplier.
nw run	Not while running	–	–	–	Parameters can only be changed when the motor is stopped.
Err.	A wrong password was entered	–	–	–	Occurs when using a wrong password for changing a password-protected parameter.

Table 6.2 Warnings and Alarms Code List

1) Mains distortions may cause these faults. Installing a Danfoss line filter may rectify this problem.

2) This alarm cannot be reset via parameter 14-20 Reset Mode automatically.

For diagnosis, read out the alarm words, warning words, and extended status words.

Bit	Hex	Dec	Alarm word (parameter 1 6-90 Alarm Word)	Alarm word 2 (parameter 1 6-91 Alarm Word 2)	Alarm word 3 (parameter 1 6-97 Alarm Word 3)	Warning word (parameter 16 -92 Warning Word)	Warning word 2 (parameter 16 -93 Warning Word 2)	Extended status word (parameter 16 -94 Ext. Status Word)	Extended status word 2 (parameter 16-95 Ex t. Status Word 2)
0	000000 01	1	Brake check	Reserved	STO function fault	Reserved	Reserved	Ramping	Off
1	000000 02	2	Pwr. card temp	Gate drive voltage fault	MM alarm	Pwr. card temp	Reserved	AMA tuning	Hand/Auto
2	000000 04	4	Earth fault	Reserved	Reserved	Reserved	Reserved	Start CW/CCW	Profibus OFF1 active
3	000000 08	8	Ctrl. card temp	Reserved	Reserved	Ctrl. card temp	Reserved	Slowdown	Profibus OFF2 active
4	000000 10	16	Ctrl. word TO	Reserved	Reserved	Ctrl. word TO	Reserved	Catchup	Profibus OFF3 active
5	000000 20	32	Overcurrent	Reserved	Reserved	Overcurrent	Reserved	Feedback high	Reserved
6	000000 40	64	Torque limit	Reserved	Reserved	Torque limit	Reserved	Feedback low	Reserved
7	000000 80	128	Motor Th. over	Reserved	Reserved	Motor Th. over	Reserved	Output current high	Control ready
8	000001 00	256	Motor ETR over	Broken belt	Reserved	Motor ETR over	Broken belt	Output current low	Frequency converter ready
9	000002 00	512	Inverter overld.	Reserved	Reserved	Inverter overld.	Reserved	Output freq. high	Quick stop
10	000004 00	1024	DC undervolt.	Start failed	Reserved	DC undervolt.	Reserved	Output freq. low	DC brake
11	000008 00	2048	DC overvolt.	Speed limit	Reserved	DC overvolt.	Reserved	Brake check OK	Stop
12	000010 00	4096	Short circuit	External interlock	Reserved	Reserved	Reserved	Braking max	Reserved
13	000020 00	8192	Reserved	Reserved	Reserved	Reserved	Reserved	Braking	Freeze output request
14	000040 00	16384	Mains ph. loss	Reserved	Reserved	Mains ph. loss	Reserved	Reserved	Freeze output
15	000080 00	32768	AMA not OK	Reserved	Reserved	No motor	Auto DC braking	OVC active	Jog request
16	000100 00	65536	Live zero error	Reserved	Reserved	Live zero error	Reserved	AC brake	Jog
17	000200 00	131072	Internal fault	Reserved	Reserved	Reserved	Reserved	Reserved	Start request
18	000400 00	262144	Brake overload	Reserved	Reserved	Brake resistor power limit	Reserved	Reserved	Start
19	000800 00	524288	U phase loss	Reserved	Reserved	Reserved	Reserved	Reference high	Reserved
20	001000 00	1048576	V phase loss	Option detection	Reserved	Reserved	Overload T27	Reference low	Start delay

Bit	Hex	Dec	Alarm word (parameter 1 6-90 Alarm Word)	Alarm word 2 (parameter 1 6-91 Alarm Word 2)	Alarm word 3 (parameter 1 6-97 Alarm Word 3)	Warning word (parameter 16 -92 Warning Word)	Warning word 2 (parameter 16 -93 Warning Word 2)	Extended status word (parameter 16 -94 Ext. Status Word)	Extended status word 2 (parameter 16-95 Ex t. Status Word 2)
21	002000 00	2097152	W phase loss	Option fault	Reserved	Reserved	Reserved	Reserved	Sleep
22	004000 00	4194304	Fieldbus fault	Locked rotor	Reserved	Fieldbus fault	Memory module	Reserved	Sleep boost
23	008000 00	8388608	24 V supply low	Position ctrl. fault	Reserved	24 V supply low	Reserved	Reserved	Running
24	010000 00	16777216	Mains failure	Reserved	Reserved	Mains failure	Reserved	Reserved	Bypass
25	020000 00	33554432	Reserved	Current limit	Reserved	Current limit	Reserved	Reserved	Reserved
26	040000 00	67108864	Brake resistor	Reserved	Reserved	Reserved	Reserved	Reserved	External interlock
27	080000 00	13421772 8	Brake IGBT	Reserved	Reserved	Reserved	Reserved	Reserved	Reserved
28	100000 00	26843545 6	Option change	Reserved	Reserved	Encoder loss	Reserved	Reserved	FlyStart active
29	200000 00	53687091 2	Frequency converter initialized	Encoder loss	Reserved	Reserved	Back EMF too high	Reserved	Heat sink clean warning
30	400000 00	10737418 24	Safe Torque Off	Reserved	Reserved	Safe Torque Off	Reserved	Reserved	Reserved
31	800000 00	21474836 48	Mech. brake low	Reserved	Reserved	Reserved	Reserved	Database busy	Reserved

Table 6.3 Description of Alarm Word, Warning Word, and Extended Status Word

WARNING/ALARM 2, Live zero error

This warning or alarm only appears if programmed in *parameter 6-01 Live Zero Timeout Function*. The signal on 1 of the analog inputs is less than 50% of the minimum value programmed for that input. Broken wiring or faulty device sending the signal can cause this condition.

Troubleshooting

- Check connections on all the analog input terminals. Control card terminals 53 and 54 for signals, terminal 55 common.
- Check that the frequency converter programming and switch settings match the analog signal type.
- Perform the input terminal signal test.

WARNING/ALARM 4, Mains phase loss

A phase is missing on the supply side, or the mains voltage imbalance is too high. This message also appears for a fault in the input rectifier. Options are programmed in *parameter 14-12 Function at Mains Imbalance*.

Troubleshooting

- Check the supply voltage and supply currents to the frequency converter.

WARNING/ALARM 7, DC overvoltage

If the DC-link voltage exceeds the limit, the frequency converter trips after a time.

Troubleshooting

- Extend the ramp time.
- Change the ramp type.

WARNING/ALARM 8, DC under voltage

If the DC-link voltage (DC-link) drops below the undervoltage limit, the frequency converter trips after a fixed time delay. The time delay varies with unit size.

Troubleshooting

- Check that the supply voltage matches the frequency converter voltage.
- Perform the input voltage test.
- Perform the soft charge circuit test.

WARNING/ALARM 9, Inverter overload

The frequency converter is about to cut out because of an overload (too high current for too long). The counter for electronic, thermal inverter protection issues a warning at 90% and trips at 100%, while giving an alarm. The frequency converter cannot be reset until the counter is below 0%.

The fault is that the frequency converter has run with more than 100% overload for too long.

Troubleshooting

- Compare the output current shown on the LCP with the frequency converter rated current.
- Compare the output current shown on the LCP with measured motor current.

- Show the thermal frequency converter load on the LCP and monitor the value. When running above the frequency converter continuous current rating, the counter increases. When running below the frequency converter continuous current rating, the counter decreases.

WARNING/ALARM 10, Motor overload temperature

According to the electronic thermal protection (ETR), the motor is too hot. Select whether the frequency converter issues a warning or an alarm when the counter reaches 100% in *parameter 1-90 Motor Thermal Protection*. The fault occurs when the motor runs with more than 100% overload for too long.

Troubleshooting

- Check for motor overheating.
- Check if the motor is mechanically overloaded.
- Check that the motor current set in *parameter 1-24 Motor Current* is correct.
- Ensure that motor data in *parameters 1-20 to 1-25* are set correctly.
- Running AMA in *parameter 1-29 Automatic Motor Adaptation (AMA)* tunes the frequency converter to the motor more accurately and reduces thermal loading.

WARNING/ALARM 11, Motor thermistor overtemp

Check whether the thermistor is disconnected. Select whether the frequency converter issues a warning or an alarm in *parameter 1-90 Motor Thermal Protection*.

Troubleshooting

- Check for motor overheating.
- Check if the motor is mechanically overloaded.
- When using terminal 53 or 54, check that the thermistor is connected correctly between either terminal 53 or 54 (analog voltage input) and terminal 50 (+10 V supply). Also check that the terminal switch for 53 or 54 is set for voltage. Check that *parameter 1-93 Thermistor Source* selects terminal 53 or 54.
- When using terminal 18, 19, 32, or 33 (digital inputs), check that the thermistor is connected correctly between the digital input terminal used (digital input PNP only) and terminal 50. Select the terminal to use in *parameter 1-93 Thermistor Source*.

WARNING/ALARM 12, Torque limit

The torque has exceeded the value in *parameter 4-16 Torque Limit Motor Mode* or the value in *parameter 4-17 Torque Limit Generator Mode*. *Parameter 14-25 Trip Delay at Torque Limit* can change this warning from a warning-only condition to a warning followed by an alarm.

Troubleshooting

- If the motor torque limit is exceeded during ramp-up, extend the ramp-up time.
- If the generator torque limit is exceeded during ramp-down, extend the ramp-down time.
- If torque limit occurs while running, increase the torque limit. Make sure that the system can operate safely at a higher torque.
- Check the application for excessive current draw on the motor.

WARNING/ALARM 13, Over current

The inverter peak current limit (approximately 200% of the rated current) is exceeded. The warning lasts about 5 s, then the frequency converter trips and issues an alarm. Shock loading or fast acceleration with high-inertia loads can cause this fault.

Troubleshooting

- Remove power and check if the motor shaft can be turned.
- Check that the motor size matches the frequency converter.
- Check *parameters 1-20 to 1-25* for correct motor data.

ALARM 14, Earth (ground) fault

There is current from the output phases to ground, either in the cable between the frequency converter and the motor, or in the motor itself.

Troubleshooting

- Remove power to the frequency converter and repair the ground fault.
- Check for ground faults in the motor by measuring the resistance to ground of the motor cables and the motor with a megohmmeter.

ALARM 16, Short circuit

There is short-circuiting in the motor or motor wiring.

- Remove power to the frequency converter and repair the short circuit.

WARNING/ALARM 17, Control word timeout

There is no communication to the frequency converter. The warning is only active when *parameter 8-04 Control Word Timeout Function* is NOT set to [0] Off.

If *parameter 8-04 Control Word Timeout Function* is set to [5] Stop and Trip, a warning appears. The frequency converter then ramps down until it trips, while giving an alarm. *Parameter 8-03 Control Timeout Time* could possibly be increased.

Troubleshooting

- Check connections on the serial communication cable.
- Increase *parameter 8-03 Control Word Timeout Time*.

- Check the operation of the communication equipment.
- Verify a proper installation based on EMC requirements.

ALARM 25, Brake resistor short circuit

The brake resistor is monitored during start-up. If a short circuit occurs, the brake function is disabled and the alarm appears. The frequency converter is tripped.

Troubleshooting

- Remove the power to the frequency converter and check the connection of the brake resistor.

WARNING/ALARM 26, Brake resistor power limit

The power transmitted to the brake resistor is calculated as a mean value over the last 120 s of run time. The calculation is based on the DC-link voltage and the brake resistor value set in *parameter 2-11 Brake Resistor (ohm)*. The warning is active when the dissipated braking power is higher than the value set in *parameter 2-12 Brake Power Limit (kW)*. The frequency converter trips if the warning keeps for 1200 s.

Troubleshooting

- Decrease brake energy via lower speed or longer ramp time.

ALARM 27, Brake IGBT/brake chopper short circuited

The brake transistor is monitored during start-up. If a short circuit occurs, the brake function is disabled, and an alarm is issued. The frequency converter is tripped.

Troubleshooting

- Remove the power to the frequency converter and remove the brake resistor.

ALARM 28, Brake check

The brake resistor is not connected or not working.

Troubleshooting

- Check if brake resistor is connected or it is too large for the frequency converter.

ALARM 30, Motor phase U missing

Motor phase U between the frequency converter and the motor is missing.

Troubleshooting

- Remove power from the frequency converter and check motor phase U.

ALARM 31, Motor phase V missing

Motor phase V between the frequency converter and the motor is missing.

Troubleshooting

- Remove power from the frequency converter and check motor phase V.

ALARM 32, Motor phase W missing

Motor phase W between the frequency converter and the motor is missing.

Troubleshooting

- Remove power from the frequency converter and check motor phase W.

WARNING/ALARM 34, Fieldbus communication fault

The fieldbus on the communication option card is not working.

ALARM 35, Option fault

An option alarm is received. The alarm is option-specific. The most likely cause is a power-up or a communication fault.

WARNING/ALARM 36, Mains failure

This warning/alarm is only active if the supply voltage to the frequency converter is lost and *parameter 14-10 Mains Failure* is not set to [0] No Function.

Troubleshooting

- Check the fuses to the frequency converter and mains supply to the unit.

ALARM 38, Internal fault

When an internal fault occurs, a code number is shown.

Troubleshooting

See *Table 6.4* for the causes and solutions for different internal faults. If the fault persists, contact the Danfoss supplier or service department for assistance.

Fault number	Cause	Solution
140–142	Power board EEPROM data error	Upgrade the software in the frequency converter to the latest version.
176	The firmware in the frequency converter does not match the frequency converter.	Upgrade the software in the frequency converter to the latest version.
256	Flash ROM checksum error	Upgrade the software in the frequency converter to the latest version.
2304	Firmware mismatch between the control card and the power card.	Upgrade the software in the frequency converter to the latest version.
2560	Communication error between the control card and the power card.	Upgrade the software in the frequency converter to the latest version. If the alarm occurs again, check the connection between the control card and the power card.
3840	Serial flash version error	Upgrade the software in the frequency converter to the latest version.

Fault number	Cause	Solution
4608	Frequency converter power size error	Upgrade the software in the frequency converter to the latest version. If the alarm occurs again, contact a Danfoss supplier.
5632	Option hardware version error	The hardware version of the option or the fieldbus variant is not compatible with the frequency converter software.
5888	Option software version error	The software version of the option or the fieldbus variant is not compatible with the frequency converter software. Change either the fieldbus software or the frequency converter software.
6144	The option is not supported	Check if the product supports this option.
6400	The option combination error	Remove the option.
Other	Other internal faults	Power cycle the frequency converter. If the alarm occurs again, contact a Danfoss supplier.

Table 6.4 Internal Fault List

WARNING 40, Overload of digital output terminal 27

Check the load connected to terminal 27 or remove the short circuit connection. Check *parameter 5-00 Digital I/O Mode* and *parameter 5-01 Terminal 27 Mode*.

ALARM 46, Power card supply

The supply for the gate drive on the power card is out of range. It is generated by the switch mode supply (SMPS) on the power card.

Troubleshooting

- Check for a defective power card.

WARNING 47, 24 V supply low

The 24 V DC is measured on the control card. This alarm appears when the detected voltage of terminal 12 is lower than 18 V.

Troubleshooting

- Check for a defective control card.

WARNING 49, Speed limit

When the speed is below the specified limit in *parameter 1-87 Trip Speed Low [Hz]* (except when starting or stopping) over 2 s, the frequency converter trips with this alarm.

ALARM 50, AMA calibration failed

A calibration error has occurred. Contact a Danfoss supplier or the Danfoss Service Department.

ALARM 51, AMA check U_{nom} and I_{nom}

The settings for motor voltage, motor current, and motor power are wrong.

Troubleshooting

- Check the settings in *parameters 1-20 to 1-25*.

ALARM 52, AMA low I_{nom}

The motor current is too low.

Troubleshooting

- Check the setting in *parameter 1-24 Motor Current*.

ALARM 53, AMA motor too big

The motor is too large for the AMA to operate.

ALARM 54, AMA motor too small

The motor is too small for the AMA to operate.

ALARM 55, AMA parameter out of range

The parameter values of the motor are outside of the acceptable range. AMA does not run.

ALARM 56, AMA interrupted by user

The AMA is manually interrupted.

ALARM 57, AMA internal fault

Try to restart AMA again. Repeated restarts can overheat the motor.

ALARM 58, AMA Internal fault

Contact a Danfoss supplier.

WARNING 59, Current limit

The current is higher than the value in *parameter 4-18 Current Limit*.

Troubleshooting

- Ensure that motor data in *parameters 1-20 to 1-25* are set correctly.
- Possibly increase the current limit.
- Be sure that the system can operate safely at a higher limit.

WARNING 60, External interlock

A digital input signal indicates a fault condition external to the frequency converter. An external interlock has commanded the frequency converter to trip.

Troubleshooting

- Clear the external fault condition.
- To resume normal operation, apply 24 V DC to the terminal programmed for external interlock.
- Reset the frequency converter.

WARNING/ALARM 61, Feedback error

An error between calculated speed and speed measurement from feedback device.

Troubleshooting

- Check the settings for warning/alarm/disabling in *parameter 4-30 Motor Feedback Loss Function*.
- Set the tolerable error in *parameter 4-31 Motor Feedback Speed Error*.

- Set the tolerable feedback loss time in *parameter 4-32 Motor Feedback Loss Timeout*.

ALARM 63, Mechanical brake low

The actual motor current has not exceeded the release brake current within the start delay time window.

WARNING/ALARM 65, Control card over temperature

The cutout temperature of the control card has exceeded the upper limit.

Troubleshooting

- Check that the ambient operating temperature is within the limits.
- Check the fan operation.
- Check the control card.

ALARM 67, Option module configuration has changed

One or more options have either been added or removed since the last power-down. Check that the configuration change is intentional and reset the unit.

WARNING/ALARM 68, Safe Torque Off

Safe Torque Off (STO) is activated. If STO is in manual restart mode (default), to resume normal operation, apply 24 V DC to terminals 37 and 38, and initiate a reset signal (via fieldbus, digital I/O, or [Reset]/[Off Reset] key). If STO is in automatic restart mode, applying 24 V DC to terminals 37 and 38 automatically resumes the frequency converter to normal operation.

WARNING/ALARM 69, Power card temperature

The cutout temperature of the power card has exceeded the upper limit.

Troubleshooting

- Check that the ambient operating temperature is within limits.
- Check fan operation.
- Check the power card.

ALARM 80, Drive initialised to default value

Parameter settings are initialized to default settings after a manual reset.

Troubleshooting

- To clear the alarm, reset the unit.

WARNING 87, Auto DC-Braking

Occurs in IT mains when the frequency converter coasts, and the DC voltage is higher than 830 V for 400 V units and 425 V for 200 V units. The motor consumes energy on the DC link. This function can be enabled/disabled in *parameter 0-07 Auto DC Braking*.

ALARM 88, Option detection

A new option configuration has been detected. Set *parameter 14-89 Option Detection* to [1] *Enable Option Change*, and power cycle the frequency converter to accept the new configuration.

ALARM 95, Broken belt

Torque is below the torque level set for no load, indicating a broken belt. *Parameter 22-60 Broken Belt Function* is set for alarm.

Troubleshooting

- Troubleshoot the system and reset the frequency converter after clearing the fault.

ALARM 99, Locked rotor

The rotor is blocked. It is only enabled for PM motor control.

Troubleshooting

- Check if the motor shaft is locked.
- Check if the start current triggers the current limit set in *parameter 4-18 Current Limit*.
- Check if it increases the value in *parameter 30-23 Locked Rotor Detection Time [s]*.

ALARM 126, Motor rotating

During AMA start-up, the motor is rotating. It is only valid for PM motor.

Troubleshooting

- Check if the motor is rotating before starting AMA.

WARNING 127, Back EMF too high

This warning applies to PM motors only. When the back EMF exceeds $90\% \times U_{inmax}$ (overvoltage threshold), and does not drop to normal level within 5 s, this warning is reported. The warning remains until the back EMF returns to a normal level.

ALARM 188, STO function fault

24 V DC supply is connected to only 1 of the 2 STO terminals (37 and 38), or a failure in STO channels is detected. Make sure that both terminals are connected to 24 V DC supply, and the discrepancy between the signals at the 2 terminals is less than 12 ms. If the fault still occurs, contact the local Danfoss supplier.

Index

A

Abbreviations..... 3
 Alarm log..... 18
 AMA..... 5, 127, 130
 Analog output..... 5
 Analog signal..... 127
 Approval and certification..... 4
 Auto on..... 19
 Automatic motor adaptation..... 5, 33

B

Brake
 power..... 5
 resistor..... 5
 resistor power limit..... 128
 Break-away torque..... 5
 Broken-belt detection..... 95
 Broken-belt torque..... 96

C

Catch up..... 53
 Coast..... 4
 Communication option..... 129
 Control
 cable..... 8
 terminal..... 19, 122, 125
 Control card
 Control card..... 127
 Current rating..... 127

D

DC brake cut-in speed..... 41
 DC braking time..... 41
 DC-brake current..... 41
 Default setting..... 19, 102
 Digital input mode..... 52
 Discharge time..... 10

E

EMC..... 128
 ETR..... 5, 90

F

Fault
 log..... 18
 Fieldbus..... 122

Freeze output..... 4
 Fuse..... 129

H

Hand on..... 19
 High voltage..... 10

I

Initialization
 Manual procedure..... 20
 Procedure..... 20
 Input signal..... 130
 Inputs
 Analog input..... 5, 127
 Digital input..... 52, 127
 Digital input mode..... 52
 Intermittent duty cycle..... 5

J

Jog..... 4

L

LCP..... 4, 6, 122
 Leakage current..... 11
 LED..... 122
 Live zero..... 62
 Load compensation..... 31
 Load sharing..... 10, 83
 Local control..... 19
 Local reference..... 23

M

Main menu..... 16, 18
 Main reactance..... 33, 34
 Mains
 supply..... 6
 Voltage..... 18
 Menu key..... 12, 18
 Menu structure..... 18
 Minimum sleep time..... 95

Motor		S	
Current.....	21	Safety.....	11
Data.....	20, 22	Serial bus.....	122
High back EMF.....	131	Serial communication.....	5, 19
control principle.....	31	Short circuit.....	128
current.....	18, 32, 130	SIL2.....	4
data.....	127, 130	SILCL of SIL2.....	4
magnetization at 0 speed.....	35	Sleep speed [Hz].....	95
pole.....	34	Slip compensation.....	6
power.....	18, 130	Standard and compliance for STO.....	4
rotating.....	131	Start delay.....	37
speed direction.....	49	Start/stop.....	8
thermal protection.....	4	Start-up.....	20
voltage.....	32	Stator leakage reactance.....	33, 34
		Stator resistance.....	34
N		Supply voltage.....	129
Navigation key.....	12, 18	Synchronous motor speed.....	4
Nominal motor speed.....	32		
Numeric display.....	12	T	
		Terminal 42	
O		Terminal 42 mode.....	63
Operating mode.....	23	Terminal 53	
Operation key.....	12, 18	Terminal 53 filter time constant.....	62
Output current.....	127	Terminal 53 high voltage.....	62
Overheating.....	127	Terminal 53 low voltage.....	62
Overtemperature.....	127	Terminal 54	
		Terminal 54 filter time constant.....	63
P		Terminal 54 high current.....	63
Phase loss.....	127	Terminal 54 high voltage.....	63
Potentiometer reference.....	9	Terminal 54 low current.....	63
Power cycle.....	6	Terminal 54 low voltage.....	63
Preset reference.....	44	Terminal 54 mode.....	63
Programming.....	18, 19, 127	Terminals	
Pulse input.....	60	Control terminal.....	19, 125
Pulse reference.....	5	Input terminal.....	127
		Thermal load.....	35, 90
Q		Thermal protection.....	4
Qualified personnel.....	10	Thermistor.....	6
Quick menu.....	14, 18	Torque	
		Torque.....	127
R		Torque [%].....	90
Rated motor current.....	4	Trip.....	6
Rated motor speed.....	4	Trip condition.....	122
RCD.....	6	Trip lock.....	122
Reference.....	18		
Relay configuration.....	57	U	
Reset.....	18, 19, 20, 127, 130	Unintended start.....	10, 83
Rotor resistance.....	34		

V

Voltage imbalance..... 127
VVC+..... 6

W

Warning and alarm list..... 124
Warning current high..... 51
Warning current low..... 51



.....
Danfoss can accept no responsibility for possible errors in catalogues, brochures and other printed material. Danfoss reserves the right to alter its products without notice. This also applies to products already on order provided that such alterations can be made without subsequential changes being necessary in specifications already agreed. All trademarks in this material are property of the respective companies. Danfoss and the Danfoss logotype are trademarks of Danfoss A/S. All rights reserved.
.....

Danfoss A/S
Ulsnaes 1
DK-6300 Graasten
vlt-drives.danfoss.com

